



Nothing but **HEAVY DUTY**.®



LDM 45

LDM 100

Original instructions

Originalbetriebsanleitung

Notice originale

Istruzioni originali

Manual original

Oorspronkelijke gebruiksaanwijzing

Original brugsanvisning

Original bruksanvisning

Bruksanvisning i original

Alkuperäiset ohjeet

Πρωτότυπο οδηγιών χρήσης

Orijinal işletme talimatı



Původním návodem k používání

Pôvodný návod na použitie

CONTENTS

Important safety instructions.....	1
Specified Conditions of Use	2
Error Code Table	2
Overview.....	3
Point of Measure	4
Menu.....	5
Start.....	6
Lenght Measuring.....	7
Surface Area Measuring.....	8
Total Area Measuring.....	9
Volume Measuring.....	10
Indirect Height/Length Measuring (LDM 100 only).....	11
Indirect Height Measuring (LDM 100 only).....	12

IMPORTANT SAFETY INSTRUCTIONS

  Do not use the product before you have studied the Safety instructions and the User Manual.

Laser Classification

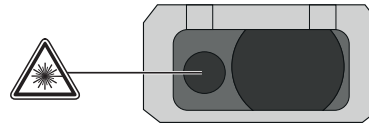

WARNING:

It is a Class 2 laser product in accordance with EN60825-1:2014 .



WARNING:

Avoid direct eye exposure. The laser beam can cause flash blindness.

Do not stare into the laser beam or direct it towards other people unnecessarily.

Don't dazzle other individuals.

WARNING:

Do not operate the tool around children or allow children to operate the tool.

The reflective surface could reflect the beam back at the operator or other persons.

Keep extremities in a safe distance from the moving parts.

Carry out periodic test measurements. Particularly before, during and after important measurements.

Watch out for erroneous measurements if the product is defective or if it has been dropped or has been misused or modified.

WARNING: Use of controls, adjustments, or the performance of procedures other than those specified in the manual may result in hazardous radiation exposure.

The laser distance measurer has limits of use. (Refer to the "Technical data" section). Attempts to measure outside the maximum and minimum range will cause inaccuracy. Use in adverse conditions including too hot, too cold, very bright sunlight, rain, snow, fog, or other vision restricting conditions will result in inaccurate readings.

When the laser distance measurer is brought into a warm environment from very cold conditions, or vice versa, allow it to come to the surrounding temperature before use.

Always store the laser distance measurer indoors, avoid exposing the tool to shock, continuous vibration or extreme temperatures.

Always keep the tool away from dust, liquids and high humidity. These may damage internal components or affect accuracy.

Do not use aggressive cleaning agents or solutions. Use only a clean, soft cloth for cleaning.

Avoid heavy impact to or dropping of the measuring tool. The accuracy of the tool should be checked before use if it has been dropped or subjected to other mechanical stresses.

Any repair required on this laser product should be performed only by authorised service personnel.

Do not operate the product in explosion hazardous areas or in aggressive environments.

 Flat batteries must not be disposed of with household waste. Care for the environment and take them to the collection points provided in accordance with national or local regulations. The product must not be disposed with household waste. Dispose of the product appropriately in accordance with the national regulations in force in your country. Adhere to the national and country specific regulations. Please contact your local authority or your dealer for how to dispose of batteries properly.

 European Conformity Mark

TECHNICAL DATA

	LDM 45	LDM 100
Receiving Lens	15 mm x 9 mm	18 mm
Measuring Range		
Minimum distance	45 meters (Tolerance: 45.1 m)	100 meters (Tolerance: 101 m)
Maximum distance	0.05 meters	0.05 meters
Distance Measurement		
Typical tolerance (applies for 100 % target reflectivity (white painted wall), low background illumination, 25 °C)	± 2.0 mm (an additional tolerance of 0.1 mm/m should be taken into account)	± 2.0 mm (an additional tolerance of 0.1 mm/m should be taken into account)
Maximum tolerance (applies to targets with lower reflectivity, high background illumination, or temperatures approaching the lower/upper limit)	± 4.0 mm (an additional tolerance of 0.15 mm/m should be taken into account)	± 4.0 mm (an additional tolerance of 0.15 mm/m should be taken into account)
Smallest unit displayed	1 mm	1 mm
Laser Spot Size		
16 m distance:	25 x 50 mm	25 x 50 mm
Laser Class	2	2
Laser Type	635 nm, < 1 mW	635 nm, < 1 mW
Laser Radiation		
Vertical Angle	± 1 degree	± 1 degree
Horizontal Angle	+ 1 degree	+ 1 degree
Display Type	LCD (31.5 mm x 40 mm)	LCD (31.5 mm x 40 mm)
Laser auto off time	90 sec	90 sec
Device auto off time	180 sec	180 sec
Power Type	AAA 2x (Alkaline Battery)	AAA 2x (Alkaline Battery)
Battery Life	8000 (Single Measure)	8000 (Single Measure)
Operating Temperature Range	0°C to +40°C	0°C to +40°C
Storage Temperature Range	-10°C to +60°C	-10°C to +60°C
Weight without Battery	87 g	122 g
Dust and Water resistance	IP54	IP54

SPECIFIED CONDITIONS OF USE

The laser distance measurer can be used for measuring distances and tilts.
Do not use this product in any other way as stated for normal use.

ERROR CODE TABLE

Code	Description	Solution
Err500	Hardware problems	Turn the meter off and back on. If the problem remains, return the meter to the nearest service center.

OVERVIEW

STATUS BAR

- ▶ Reference Point of Measurement, Type of Measurement, Angle (LDM 100 only), Level (LDM 100 only)

DISPLAY

- ▶ Menu
- ▶ Measurements
- ▶ Settings

UP / ADD

- ▶ navigate up through menus
- ▶ add value

MEASURE / OK

- ▶ turn the laser on
- ▶ store measurement
- ▶ select OK in the menu

MENU

- ▶ History
- ▶ Measurement
- ▶ Settings

DOWN / SUBTRACT

- ▶ navigate down through menus
- ▶ subtract value

CLEAR / POWER

- ▶ on / off (press and hold until unit beeps)
- ▶ clear measurement

POINT OF MEASURE

- ▶ Bottom (Standard automatic)
- ▶ Front
- ▶ Corner pin (activating automatically by extending the lever)



MEASURE

- ▶ turn the laser on
- ▶ store measurement

CHANGE BATTERIES

Change batteries when battery symbol is flashing.

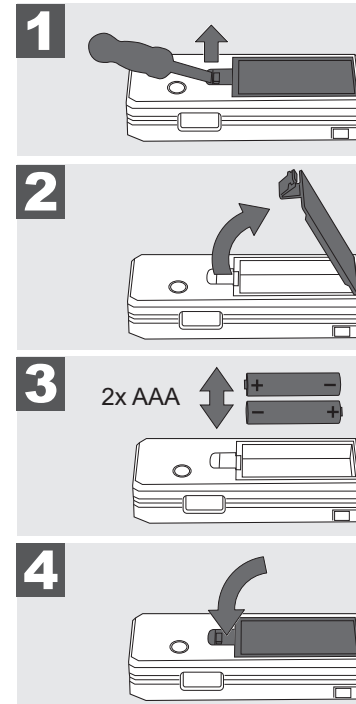

TRIPOD

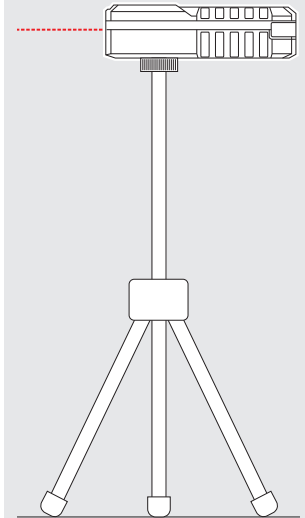

CORNER PIN

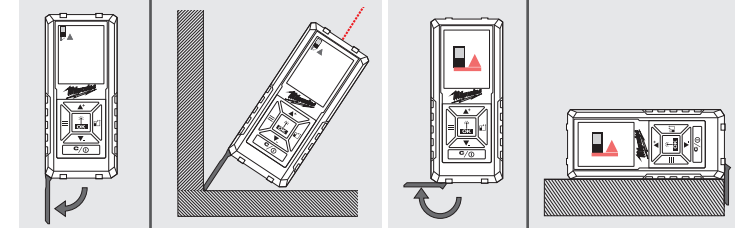

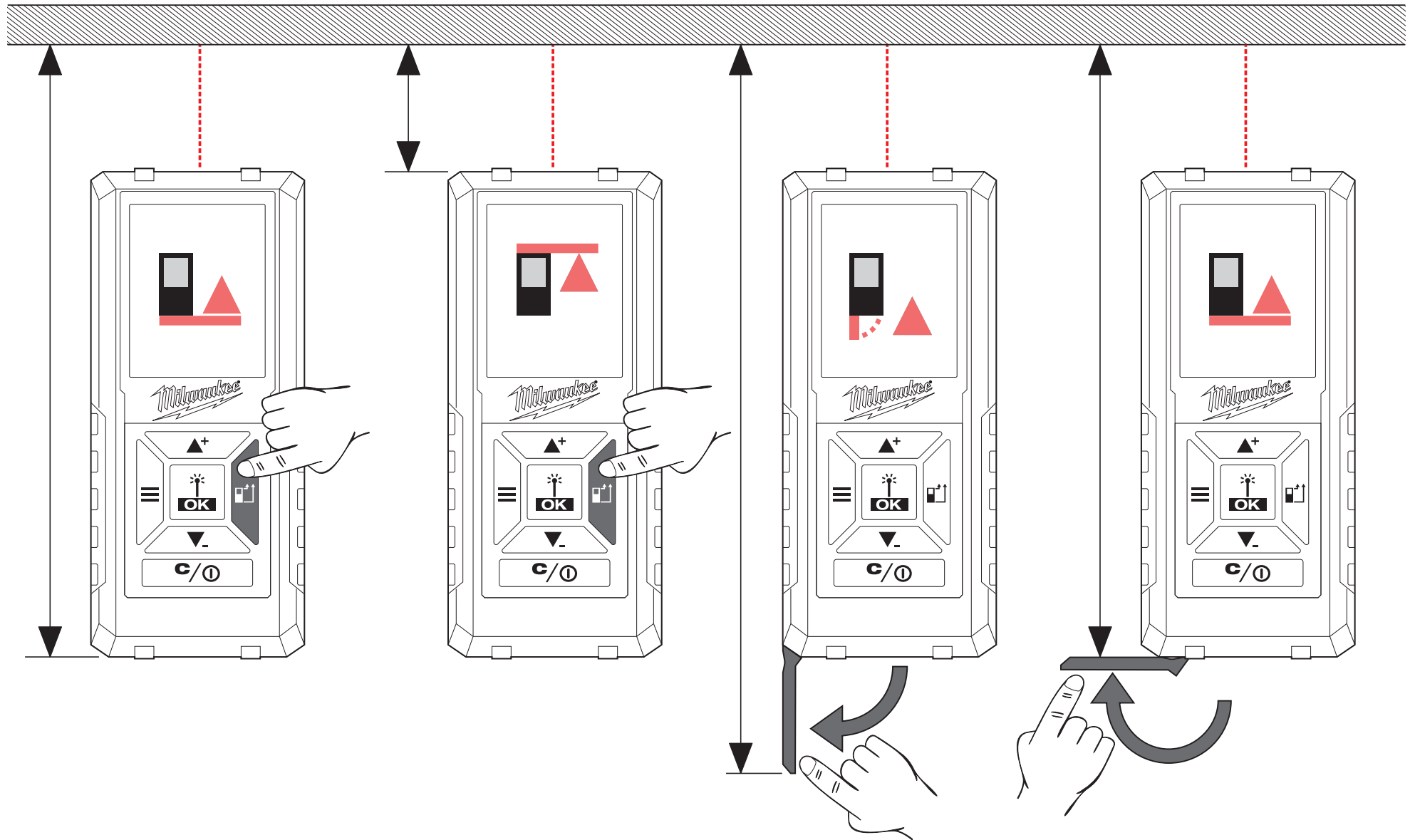

MENU

HISTORY

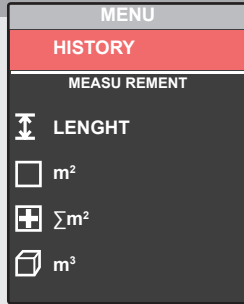

The last 30 measurements/calculations are displayed.

The measurements made to calculate surface area, total area, volume, etc., are not stored in HISTORY. Only the resulting calculation is stored.

To delete an entry press the Clear/Power button.

Additional measurements/calculations can be added or subtracted from entries stored in HISTORY. Only calculations of the same type (length, area, volume, etc.) can be made.

To perform a calculation:

1. Use the ▲+ ▼- buttons to highlight an individual measurement from the HISTORY.
2. Press the OK button.
3. Make the measurement(s) to be used in the calculation.
4. Press the OK button to save the new calculation to HISTORY.

MEASUREMENT

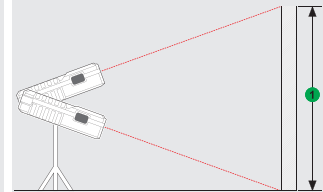
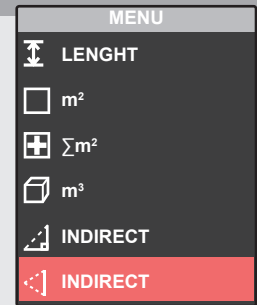
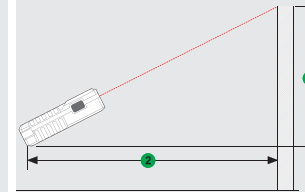
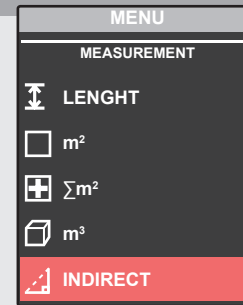
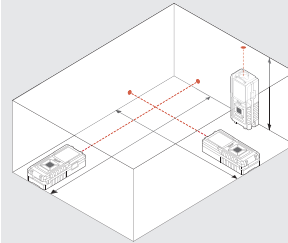
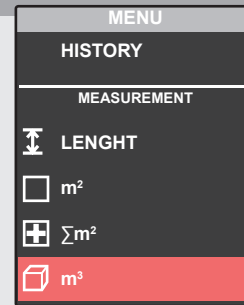
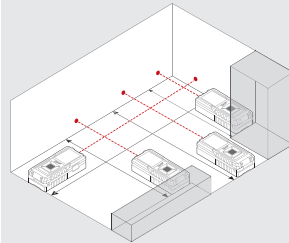
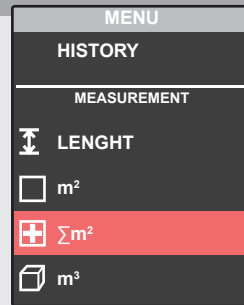
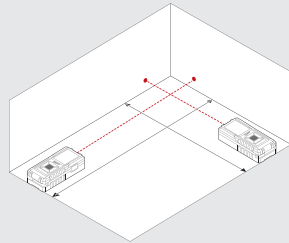
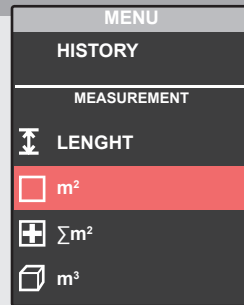
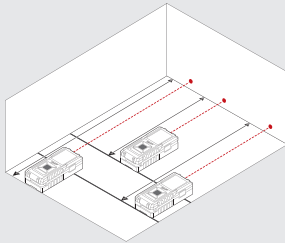
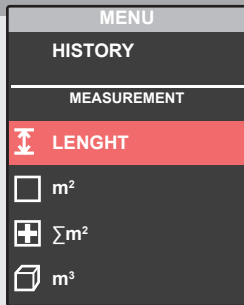

SETTINGS

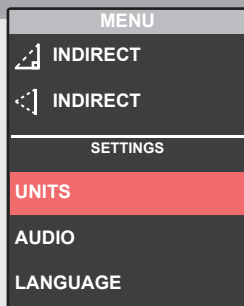

Select desired unit display.

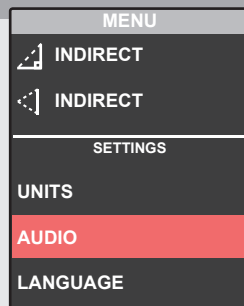

Audio beep on/off.

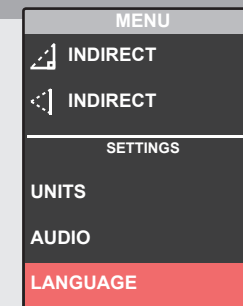

Change language.

START

1

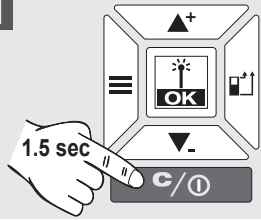

2

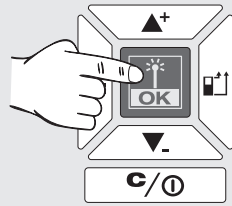

3

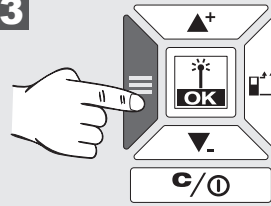

4

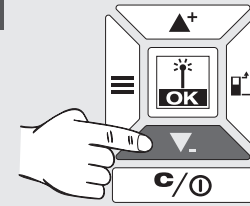

5

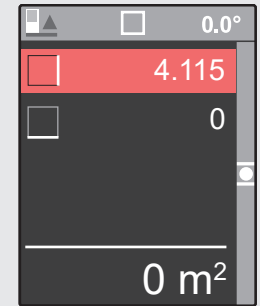
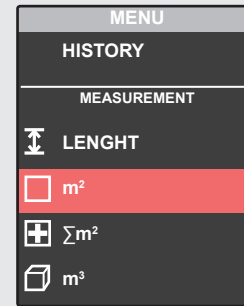
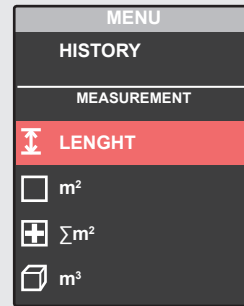
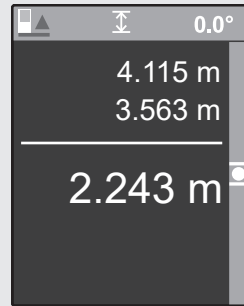
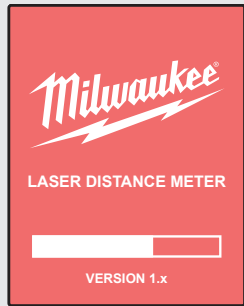
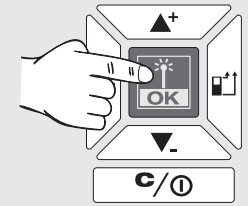

After turning on, the meter goes directly to the LENGHT MEASURE MODE

Make a LENGTH measurement or...

...press the mode button to switch to the Menu...

...and choose another mode by pressing the ▲+ ▼- button...

...and switch to this mode by pressing the OK button.

LENGHT MEASURING

0

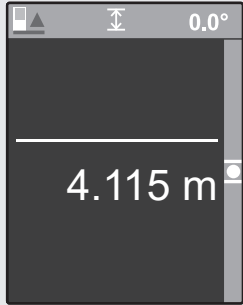

Value white = value is measured

1

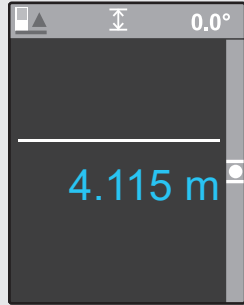
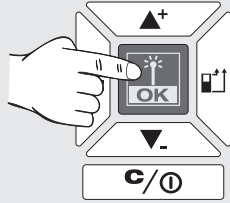

Value blue = value is freezing

2

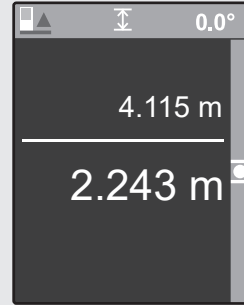
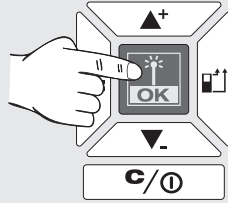

3

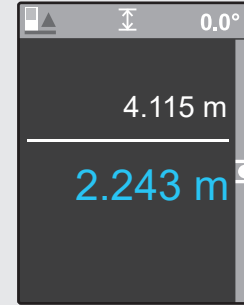
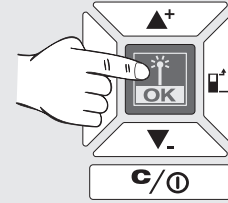

4

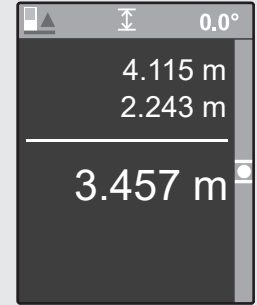
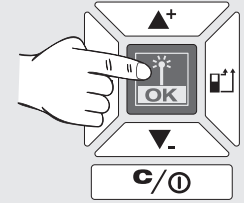

5

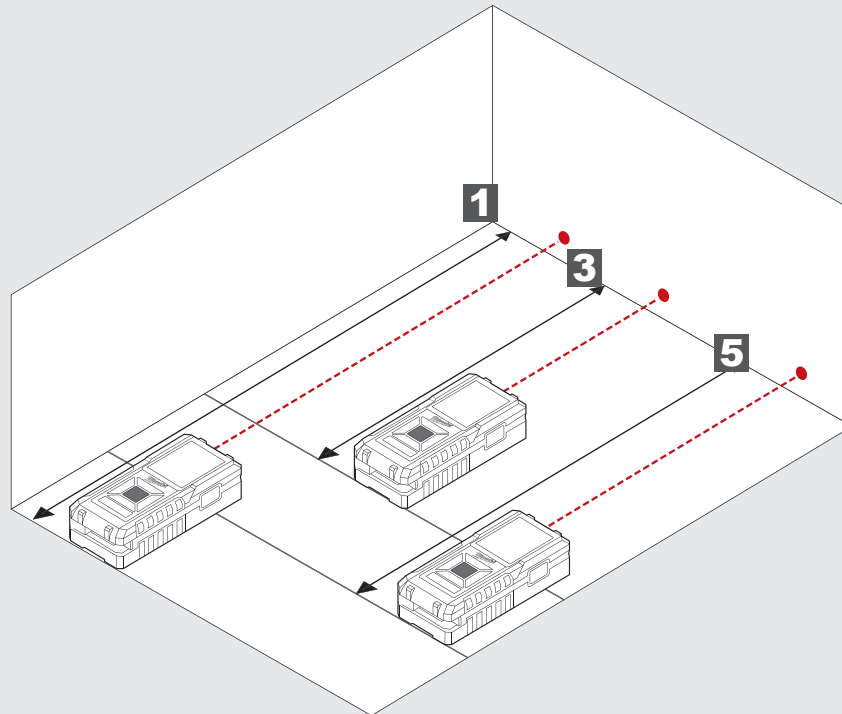
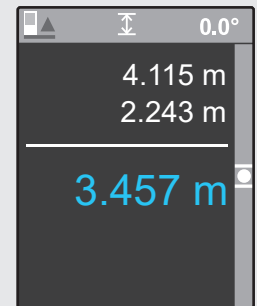
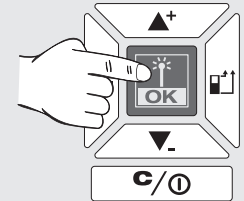

SURFACE AREA MEASURING

0

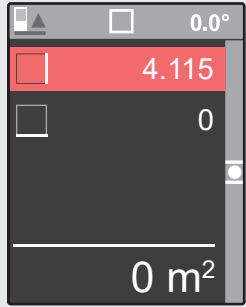

1

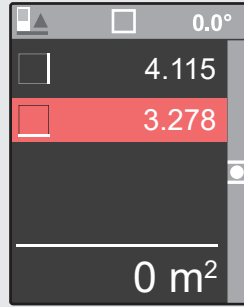
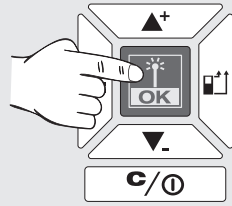

2

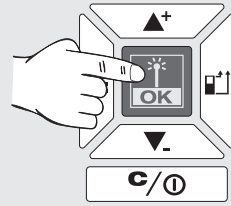

2

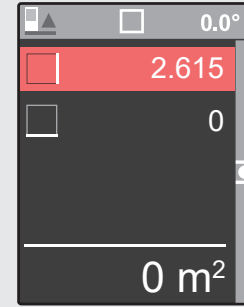
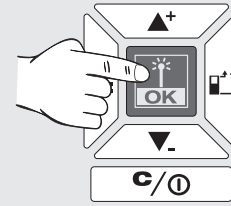

New measurement.
Value is stored in HISTORY.

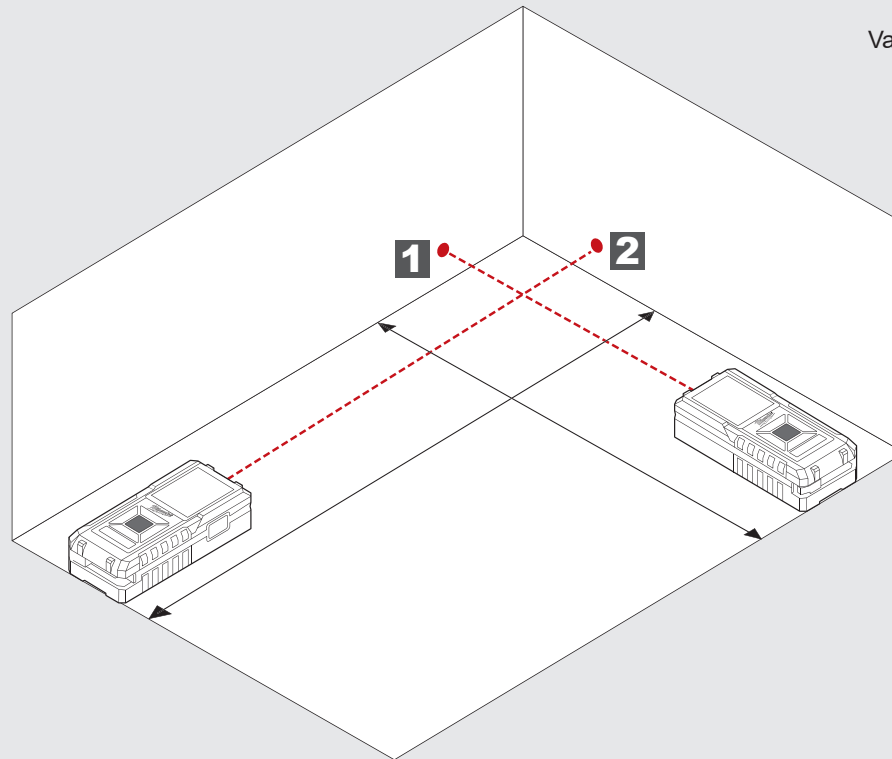

TOTAL AREA MEASURING

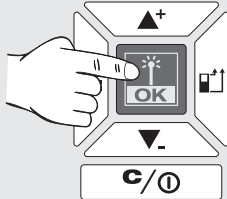
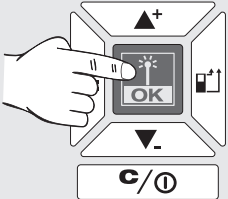
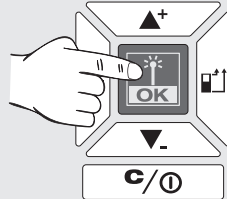
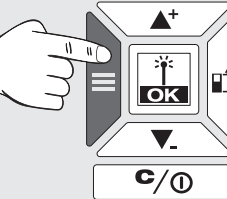
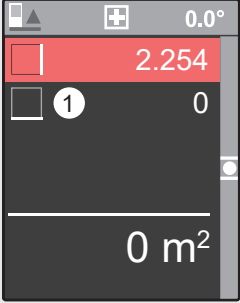
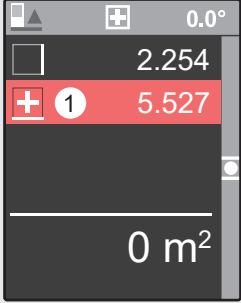
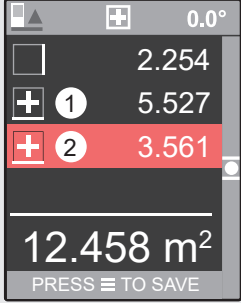
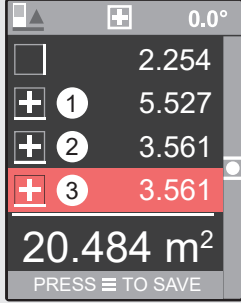
<p>0</p>  <p>c/0</p>	<p>1</p>  <p>c/0</p>	<p>2</p>  <p>c/0</p>	<p>3</p>  <p>c/0</p>
			

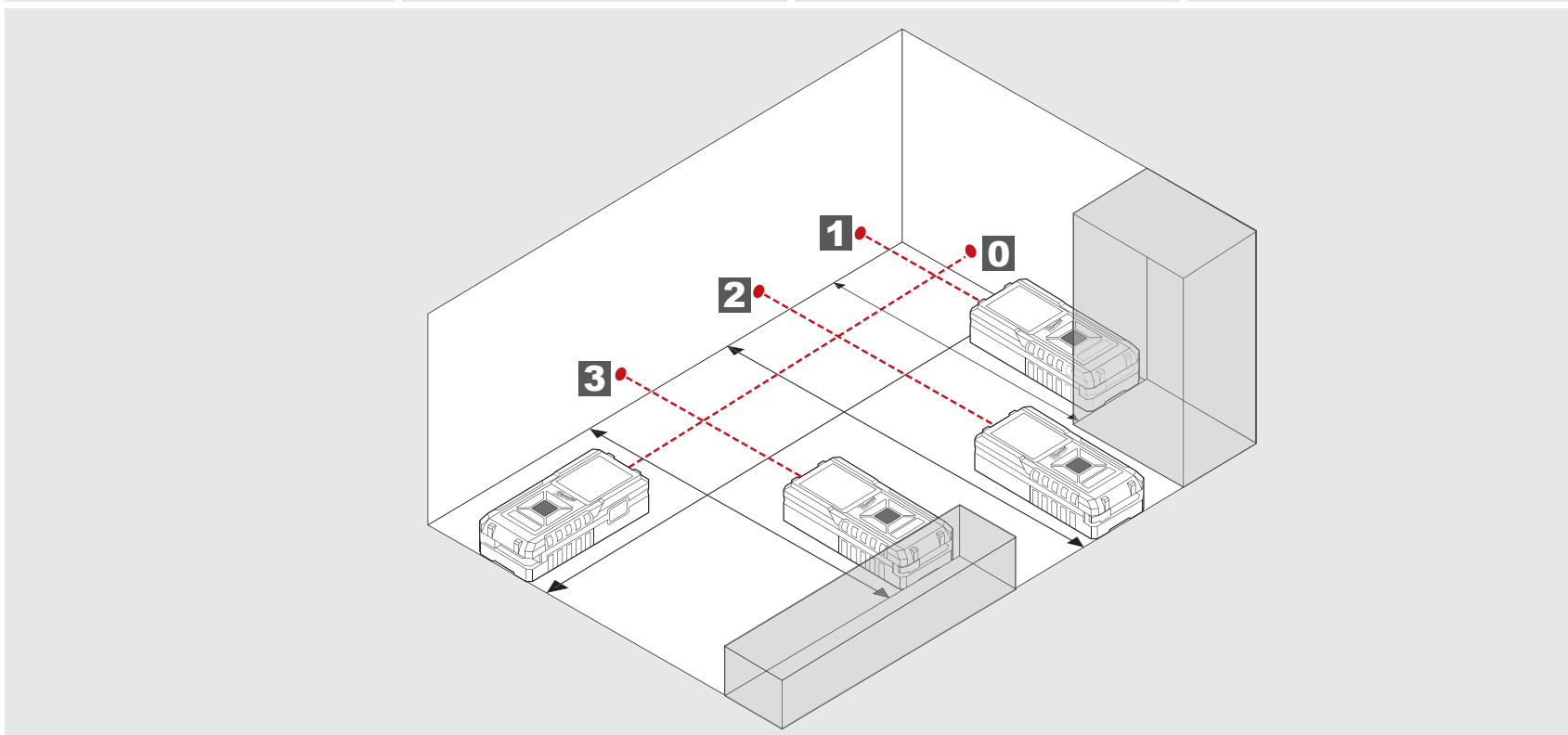

4

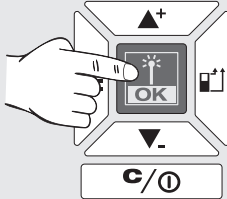

c/0

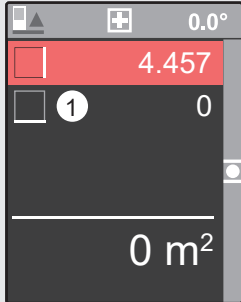

New measurement.
Resulting is stored in HISTORY.

VOLUME MEASURING

0

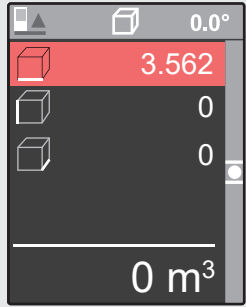

1

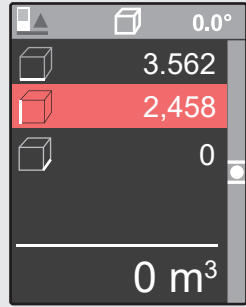
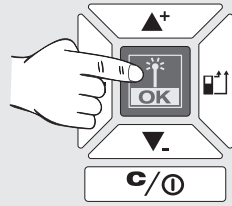

2

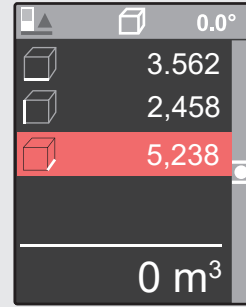
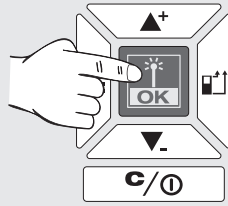

3

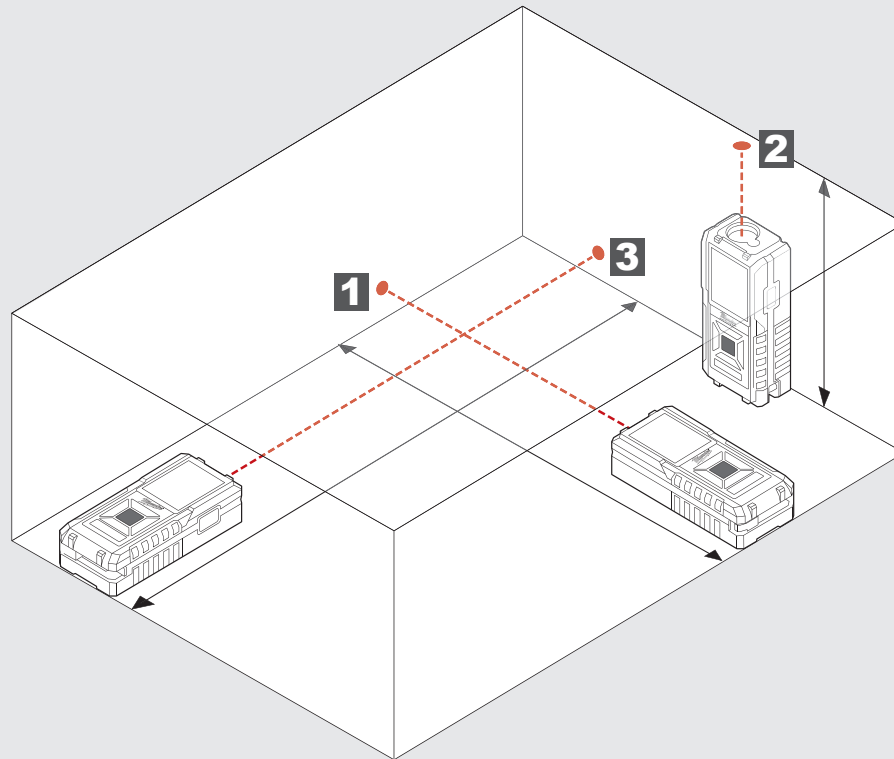
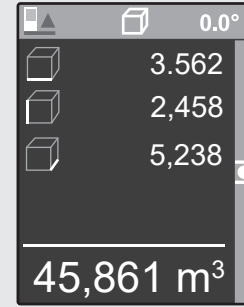
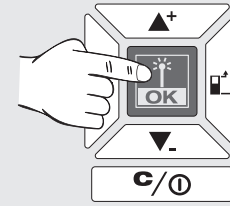

INDIRECT HEIGHT/LENGTH MEASURING (LDM 100 only)

0

1

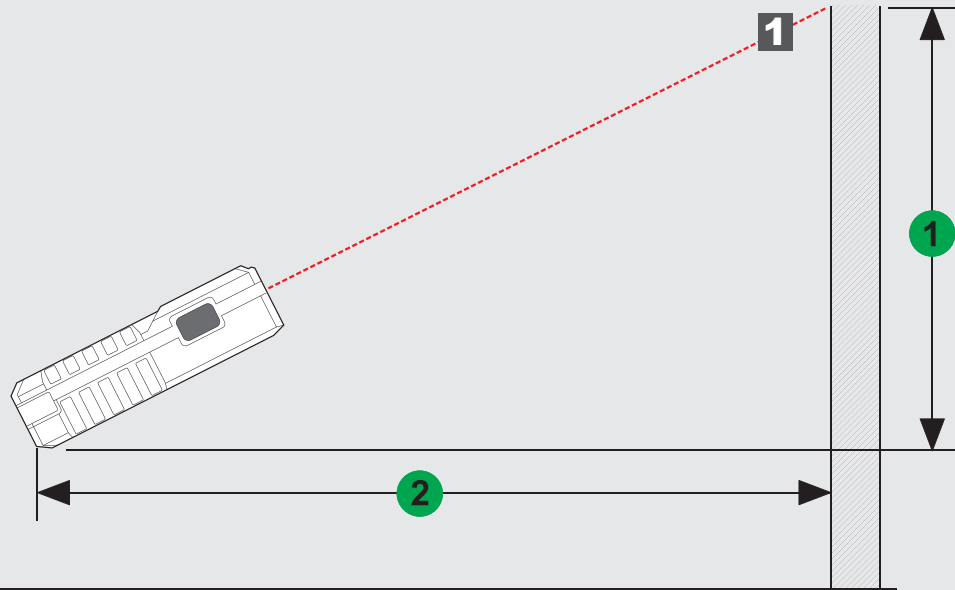
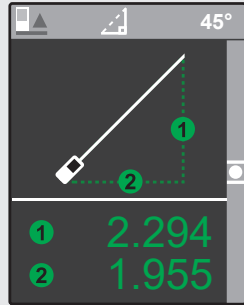
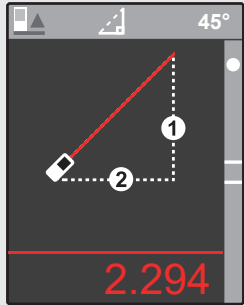
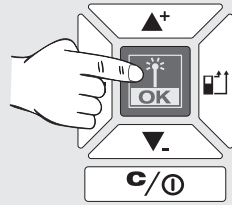

INDIRECT HEIGHT MEASURING (LDM 100 only)

0

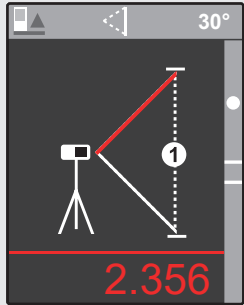

1

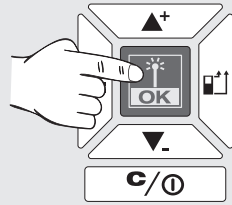

2

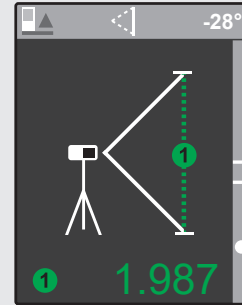
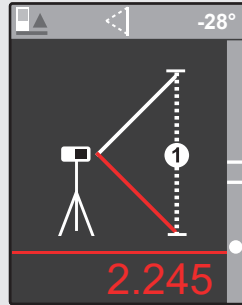
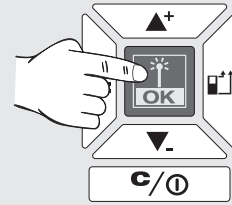

Use a tripod or other stable surface to make two length measurements.

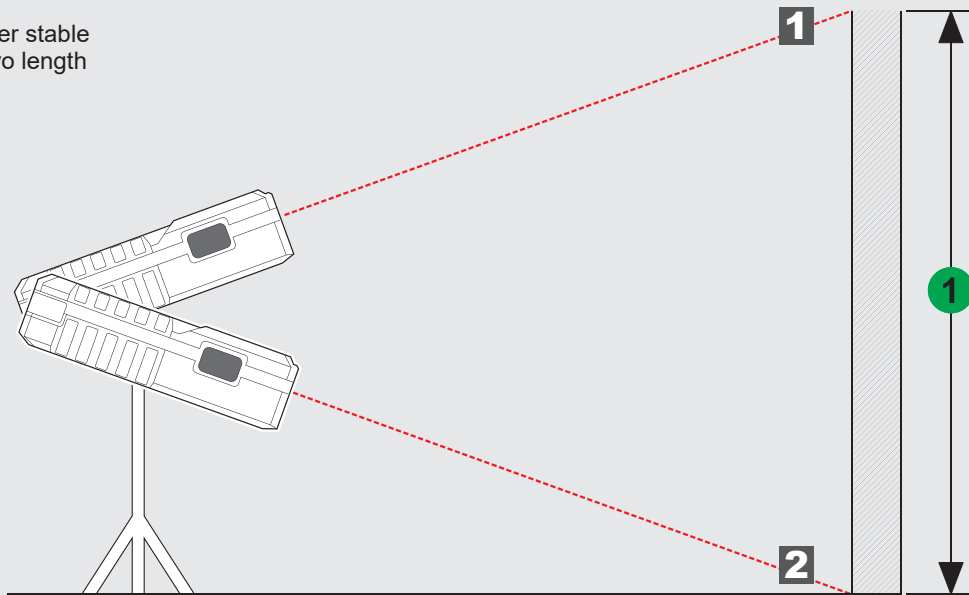

INHALT

Wichtige Sicherheitshinweise	1
Technische Daten	2
Bestimmungsgemäße Verwendung	2
Fehlercode Tabelle	2
Übersicht	3
Menü	5
Starten	6
Länge messen	7
Fläche messen	8
Gesamtfläche messen	9
Volumen messen	10
Indirekte Höhen-/Längenmessung (nur mit LDM 100)	11
Indirekte Höhenmessung (nur mit LDM 100)	12

WICHTIGE SICHERHEITSHINWEISE



Nehmen Sie das Produkt erst in Gebrauch, wenn Sie die Sicherheitshinweise und die Gebrauchsanweisung auf der beiliegenden CD gelesen haben.

Laserklassifizierung

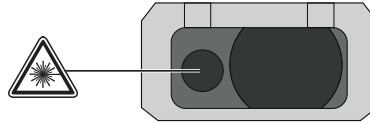

WARNUNG:

Das Produkt entspricht der Laserklasse 2 gemäss EN60825-1:2014



Warnung:

Vermeiden Sie direkten Blickkontakt. Der Laserstrahl kann die Augen verblitzen und zu einer kurzzeitigen Blendung führen.

Nicht in den Laserstrahl blicken und Strahl nicht unnötigerweise auf andere Personen richten.

Keine anderen Personen blenden.

Warnung:

Das Laser-Gerät nicht in der Nähe von Kindern betreiben oder Kindern erlauben, das Laser-Gerät zu benutzen.

Achtung! Eine reflektierende Oberfläche könnte den Laserstrahl zurück an den Bediener oder andere Personen reflektieren.

Halten Sie einen entsprechenden Sicherheitsabstand zu den beweglichen Teilen.

Regelmässige Kontrollmessungen durchführen, insbesondere vor, während und nach wichtigen Messaufgaben.

Vorsicht vor fehlerhaften Messungen beim Verwenden eines defekten Produkts, nach einem Sturz oder sonstigen unzulässigen Anwendungen bzw. Veränderungen am Produkt.

Warnung: Die Verwendung von Steuerelementen, Einstellungen oder die Durchführung von anderen als den im Handbuch festgelegten Verfahren kann zu gefährlicher Strahlenbelastung führen.

Das Lasermessgerät hat einen begrenzten Einsatzbereich. (Siehe Abschnitt "Technische Daten"). Versuche, außerhalb des maximalen und minimalen Bereichs zu messen, verursachen Ungenauigkeiten. Der Einsatz bei widrigen Bedingungen, wie zu heiß, zu kalt, sehr hellem Sonnenlicht, Regen, Schnee, Nebel oder anderen sichteinschränkenden Bedingungen, kann zu ungenauen Messungen führen.

Wenn das Lasermessgerät von einer warmen Umgebung in eine kalte Umgebung gebracht wird (oder umgekehrt), warten Sie, bis sich das Gerät der neuen Umgebungstemperatur angepasst hat.

Das Lasermessgerät immer innerhalb von Räumen aufbewahren, das Gerät vor Erschütterung, Vibrationen oder extremen Temperaturen schützen.

Das Lasermessgerät vor Staub, Nässe und hoher Luftfeuchtigkeit schützen. Dies kann innere Bauteile zerstören oder die Genauigkeit beeinflussen.

Verwenden Sie keine aggressiven Reinigungsmittel oder Lösungsmittel. Nur mit einem sauberen, weichen Tuch reinigen.

Vermeiden Sie starke Schläge auf das oder den Fall des Lasermessgeräts. Die Genauigkeit des Gerätes sollte überprüft werden, wenn es heruntergefallen ist oder anderen mechanischen Belastungen ausgesetzt war.

Erforderlichen Reparaturen an diesem Laser-Gerät dürfen nur von autorisiertem Fachpersonal durchgeführt werden.

Das Produkt darf nicht in einer explosionsgefährdeten oder aggressiven Umgebung eingesetzt werden.

 Leere Batterien dürfen nicht über den Hausmüll entsorgt werden. Gebrauchte Batterien zur umweltgerechten Entsorgung gemäß nationaler oder lokaler Vorschriften an den dafür vorgesehenen Sammelstellen abgeben. Das Gerät darf nicht im Hausmüll entsorgt werden. Gerät sachgemäß entsorgen. Länderspezifische Entsorgungsvorschriften befolgen. Wenden Sie sich an die örtliche Behörde oder Ihren Händler, um Auskunft über die Entsorgung zu erhalten.

 CE-Zeichen

TECHNISCHE DATEN

	LDM 45	LDM 100
Optik	15 mm x 9 mm	18 mm
Messbereich		
Minimaler Abstand	45 m (Toleranz: 45,1 m)	100 m (Toleranz: 101 m)
Maximaler Abstand	0,05 m	0,05 m
Abstandsmessung		
Typische Toleranz (gilt für 100 % Zielreflexion (weiß lackierte Wand), geringe Hintergrundbeleuchtung, 25 °C)	± 2,0 mm (eine zusätzliche Toleranz von 0,1 mm/m sollte berücksichtigt werden)	± 2,0 mm (eine zusätzliche Toleranz von 0,1 mm/m sollte berücksichtigt werden)
Maximale Toleranz (gilt für Ziele mit geringerer Reflexion, hoher Hintergrundbeleuchtung oder Temperaturen, die sich dem unteren/oberen Wert nähern)	± 4,0 mm (eine zusätzliche Toleranz von 0,15 mm/m sollte berücksichtigt werden)	± 4,0 mm (eine zusätzliche Toleranz von 0,15 mm/m sollte berücksichtigt werden)
Kleinste anzeigbare Einheit	1,0 mm	1,0 mm
Laserpunktgröße		
16 m Entfernung:	25 x 50 mm	25 x 50 mm
Laserklasse	2	2
Lasertyp	635 nm, < 1 mW	635 nm, < 1 mW
Laserstrahl		
Vertikalwinkel	+1 Grad	+1 Grad
Horizontalwinkel	±1 Grad	±1 Grad
Display Typ	LCD (31,5 mm x 40 mm)	LCD (31,5 mm x 40 mm)
Automatische Laserabschaltung	90 Sekunden	90 Sekunden
Automatische Geräteabschaltung	180 Sekunden	180 Sekunden
Stromversorgung	AAA 2x (Alkaline-Batterie)	AAA 2x (Alkaline-Batterie)
Batterielebensdauer	8000 (Einzelmessung)	8000 (Einzelmessung)
Arbeitstemperaturbereich	-0°C bis +40°C	-0°C bis +40°C
Lagertemperaturbereich	-10°C bis +60°C	-10°C bis +60°C
Gewicht ohne Batterie	87 g	122 g
Schutzklasse	IP54 (staub- und spritzwassergeschützt)	IP54 (staub- und spritzwassergeschützt)
Dust and Water resistance	IP54	IP54

BESTIMMUNGSGEMÄSSE VERWENDUNG

Das Lasermessgerät ist geeignet zum Messen von Distanzen und Neigungen.
Dieses Gerät darf nur wie angegeben bestimmungsgemäß verwendet werden.

FEHLERCODE TABELLE

Code	Beschreibung	Lösung
Err500	Hardwareprobleme	Schalten Sie das Messgerät aus und wieder ein. Bleibt das Problem bestehen, bringen Sie das Messgerät zur nächsten Servicezentrale.

ÜBERSICHT

STATUSLEISTE

- ▶ Referenzmesspunkt, Art der Messung, Messwinkel (nur mit LDM 100), Messebene (nur mit LDM 100)

DISPLAY

- ▶ Menü
- ▶ Messungen
- ▶ Einstellungen

NACH OBEN / ADDIEREN

- ▶ Im Menü nach oben gehen
- ▶ Wert addieren

MESSUNG / OK

- ▶ Laser einschalten
- ▶ Messwert speichern
- ▶ OK im Menü anwählen

MENÜ

- ▶ Verlauf
- ▶ Messung
- ▶ Einstellungen

NACH UNTEN / SUBTRAHIEREN

- ▶ Im Menü nach unten gehen
- ▶ Wert subtrahieren

LÖSCHEN / EIN-/AUSSCHALTEN

- ▶ EIN / AUS (Taste gedrückt halten, bis das Gerät einen Signalton ausgibt)
- ▶ Messwert löschen

MESSPUNKT

- ▶ Hinten (Standardeinstellung)
- ▶ Vorne
- ▶ Ecke (wird automatisch durch Ausklappen des Stifts aktiviert)



MESSEN

- ▶ Laser einschalten
- ▶ Messwert speichern

BATTERIEN WECHSELN

- ▶ Batterien wechseln, wenn das Batteriesymbol blinkt.

1

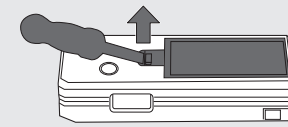

2

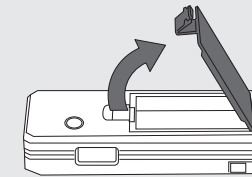

3

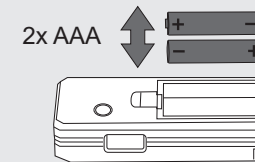

4

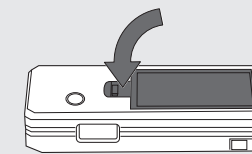

STATIV

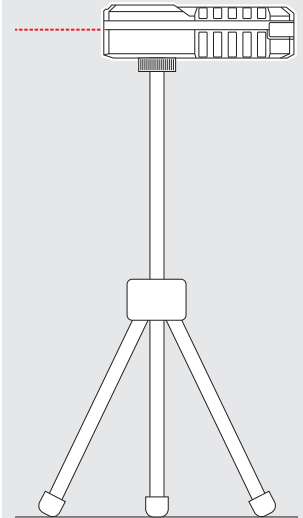

ECKSTIFT

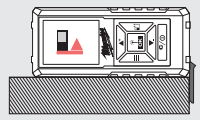
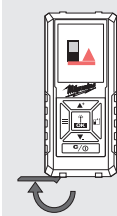
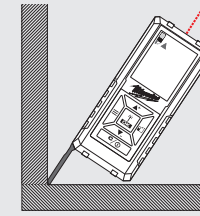

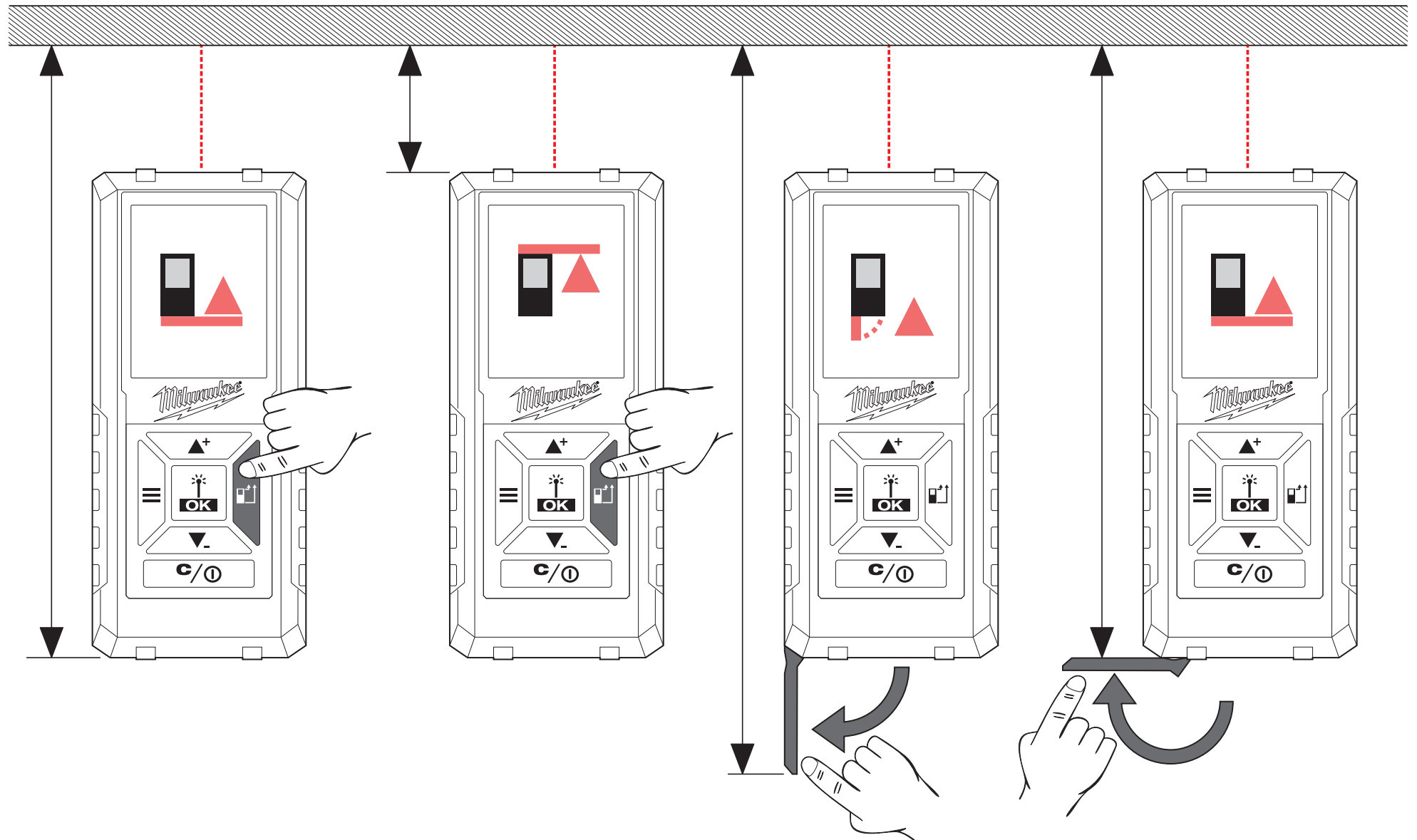

MENÜ

VERLAUF



Anzeige der letzten 30 Messungen/
Berechnungen.

Die Einzelmessungen zur Berechnung von
Oberfläche, Gesamtfläche, Volumen etc.
werden nicht unter VERLAUF gespeichert,
sondern nur das Ergebnis der Berechnungen.

Um einen Eintrag zu löschen, die Taste C/EIN/
AUS drücken.

Zu den unter VERLAUF gespeicherten Werten
können Messungen/Berechnungen addiert
oder von ihnen subtrahiert werden. Es können
nur Berechnungen derselben Art ausgeführt
werden (Länge, Fläche, Volumen etc.).

Durchführen einer Berechnung:

1. Die Tasten ▲+ ▼- verwenden, um einen
Messmodus aus dem VERLAUF
auszuwählen.
2. Die OK-Taste drücken.
3. Die zur Berechnung erforderlichen
Messungen durchführen.
4. Die Taste OK drücken, um die neue
Berechnung im VERLAUF zu speichern.

MESSUNG

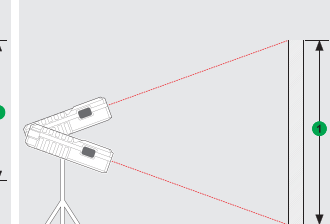
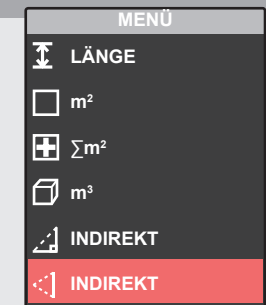
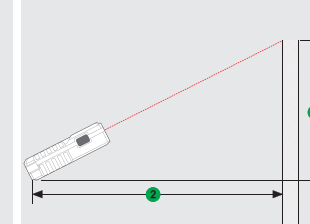
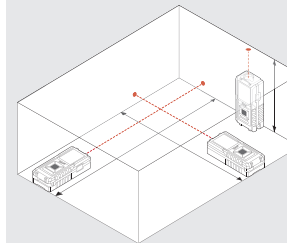
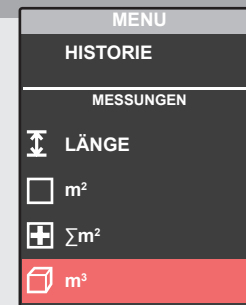
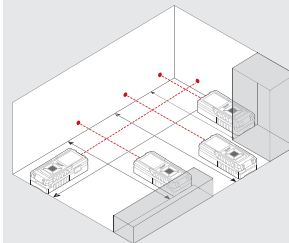
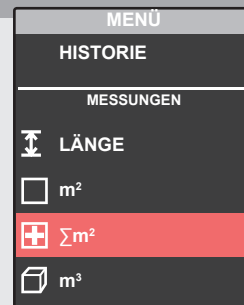
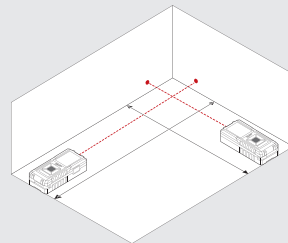
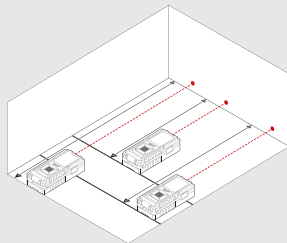
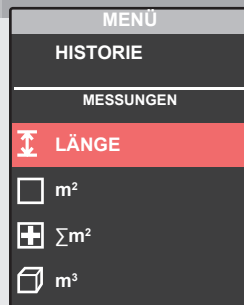

EINSTELLUNGEN

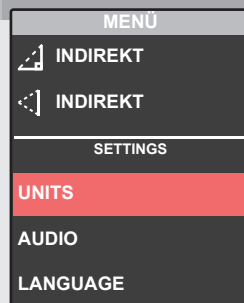

Die gewünschte
Maßeinheit wählen.

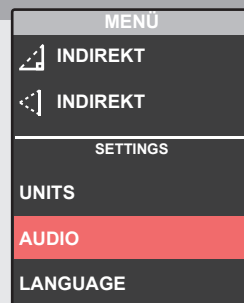

Signalton an/aus.

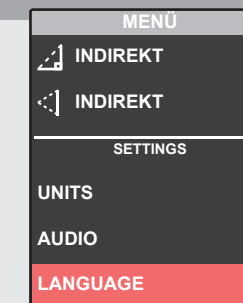

Sprache wählen.

STARTEN

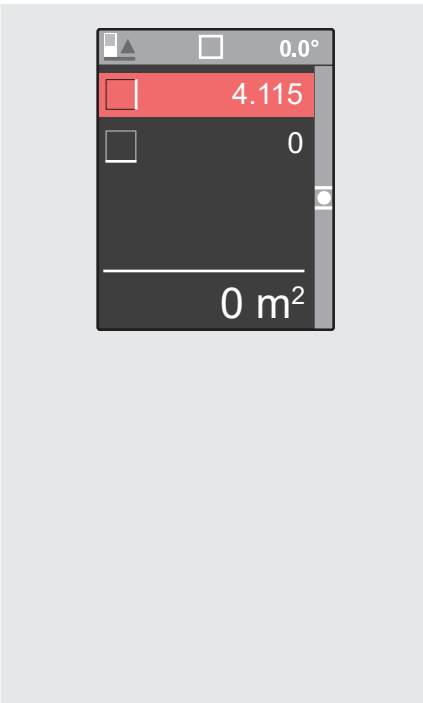
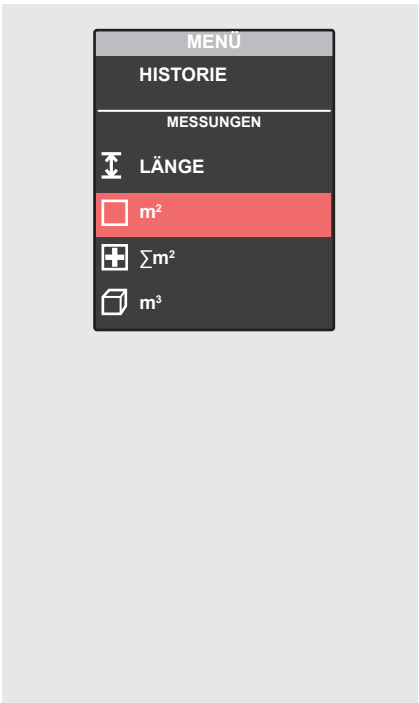
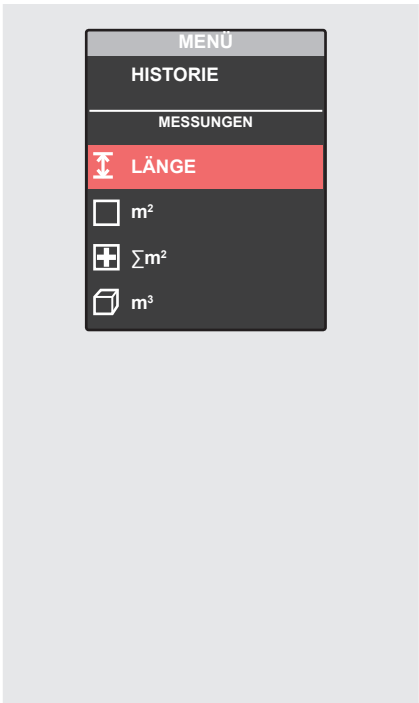
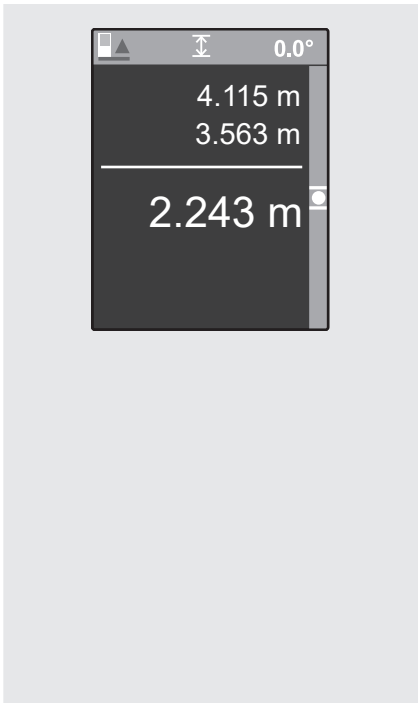
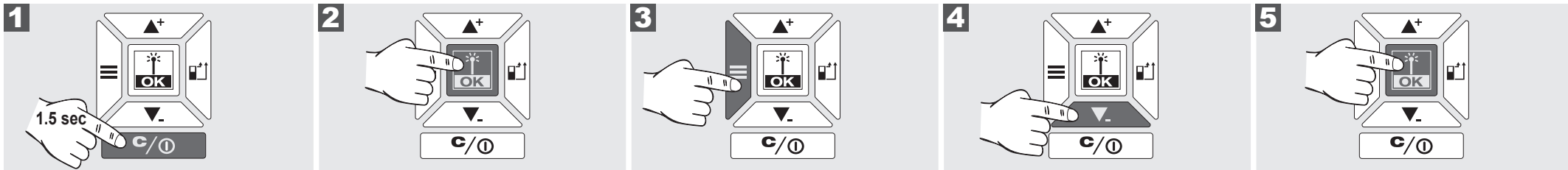

Nach dem Einschalten wird automatisch der LÄNGENMESSMODUS aktiviert.

Führen Sie eine LÄNGENMESSUNG durch oder ...

... drücken Sie die Menütaste, um zum Menü zu wechseln ...

... und wählen Sie eine andere Betriebsart mit Hilfe der Tasten ▲+ ▼- und ...

... und aktivieren Sie diese Betriebsart durch Drücken der Taste OK.

LÄNGE MESSEN

0

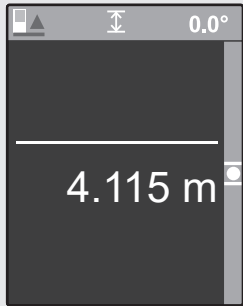

Messwert weiß = Wert gemessen

1

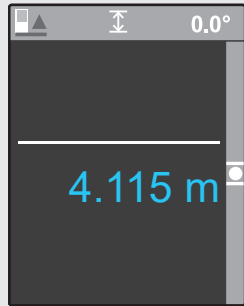
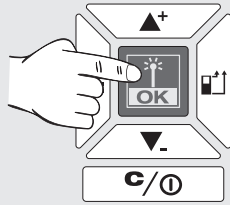

Messwert blau = Wert zwischengespeichert

2

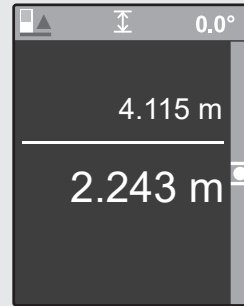
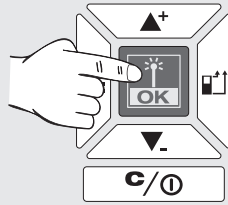

3

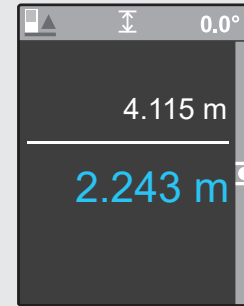
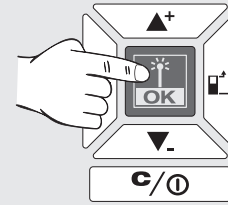

4

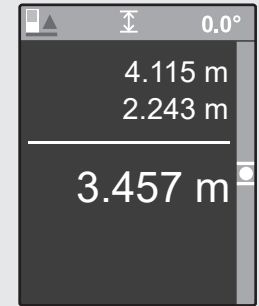
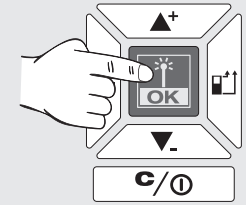

5

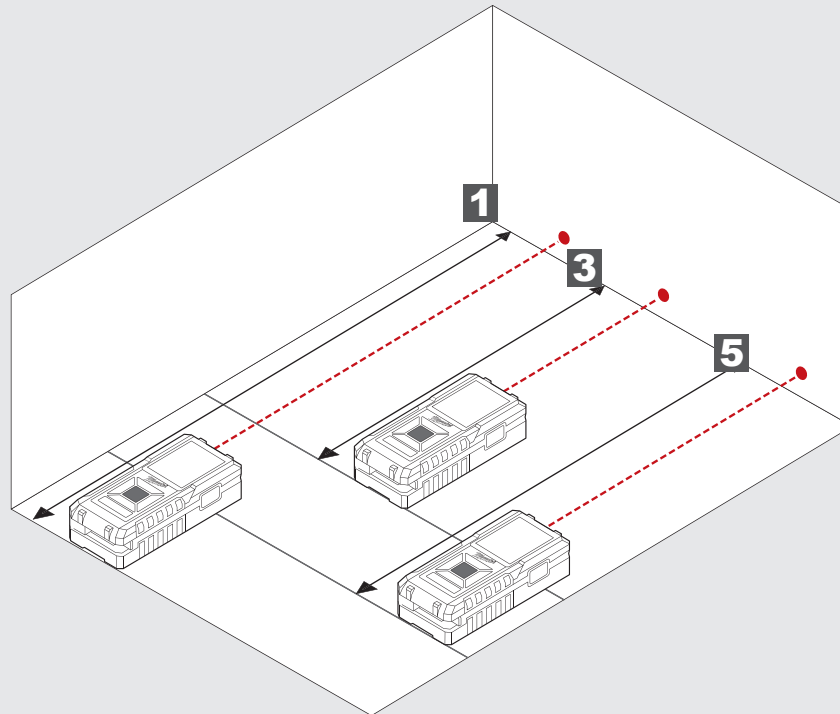
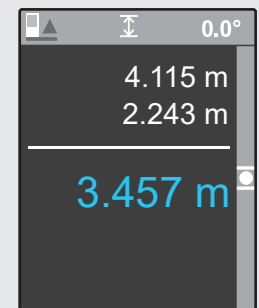
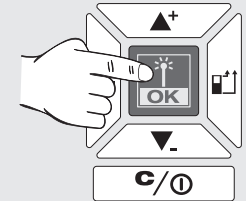

FLÄCHE MESSEN

0

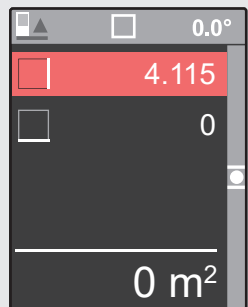

1

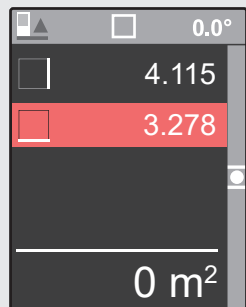
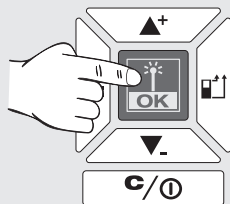

2

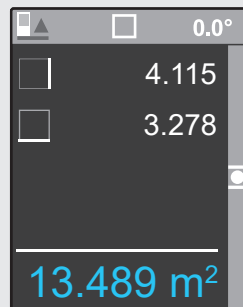
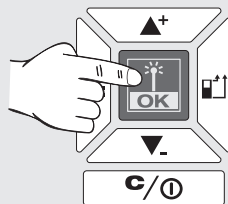

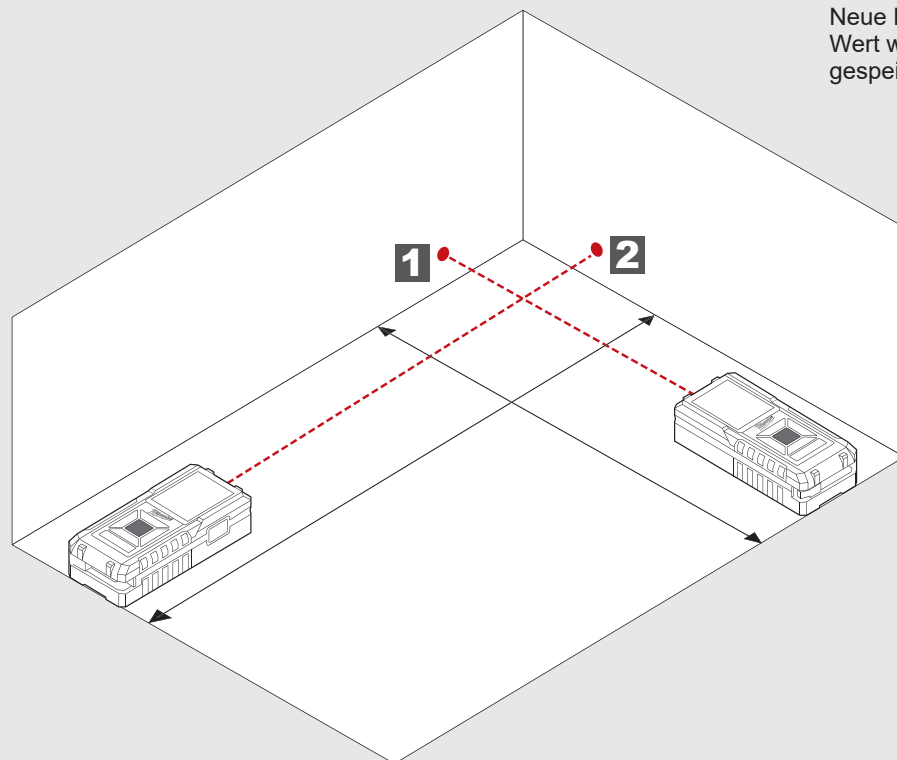
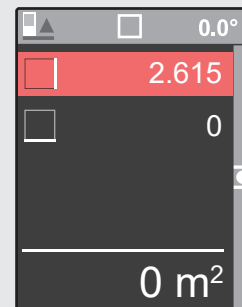
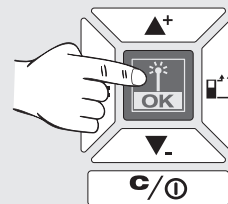

2

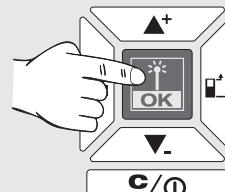
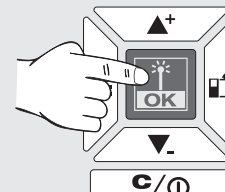
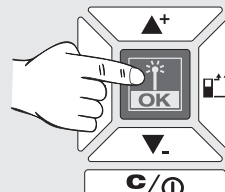
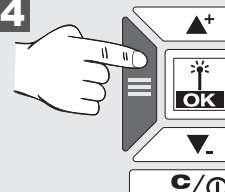
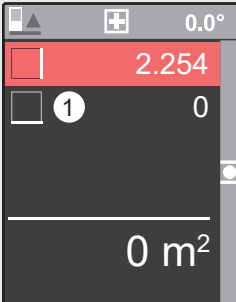
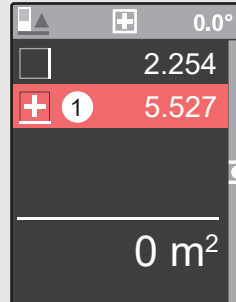
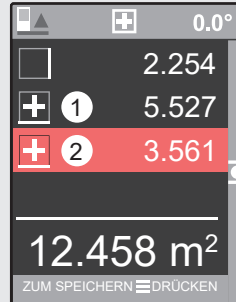
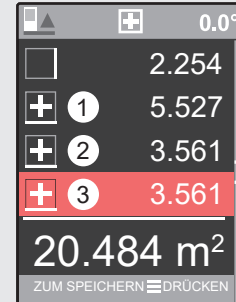

Neue Messung.
Wert wird unter VERLAUF
gespeichert.

GESAMTFLÄCHE MESSEN

0	1 	2 	3 	4 
				

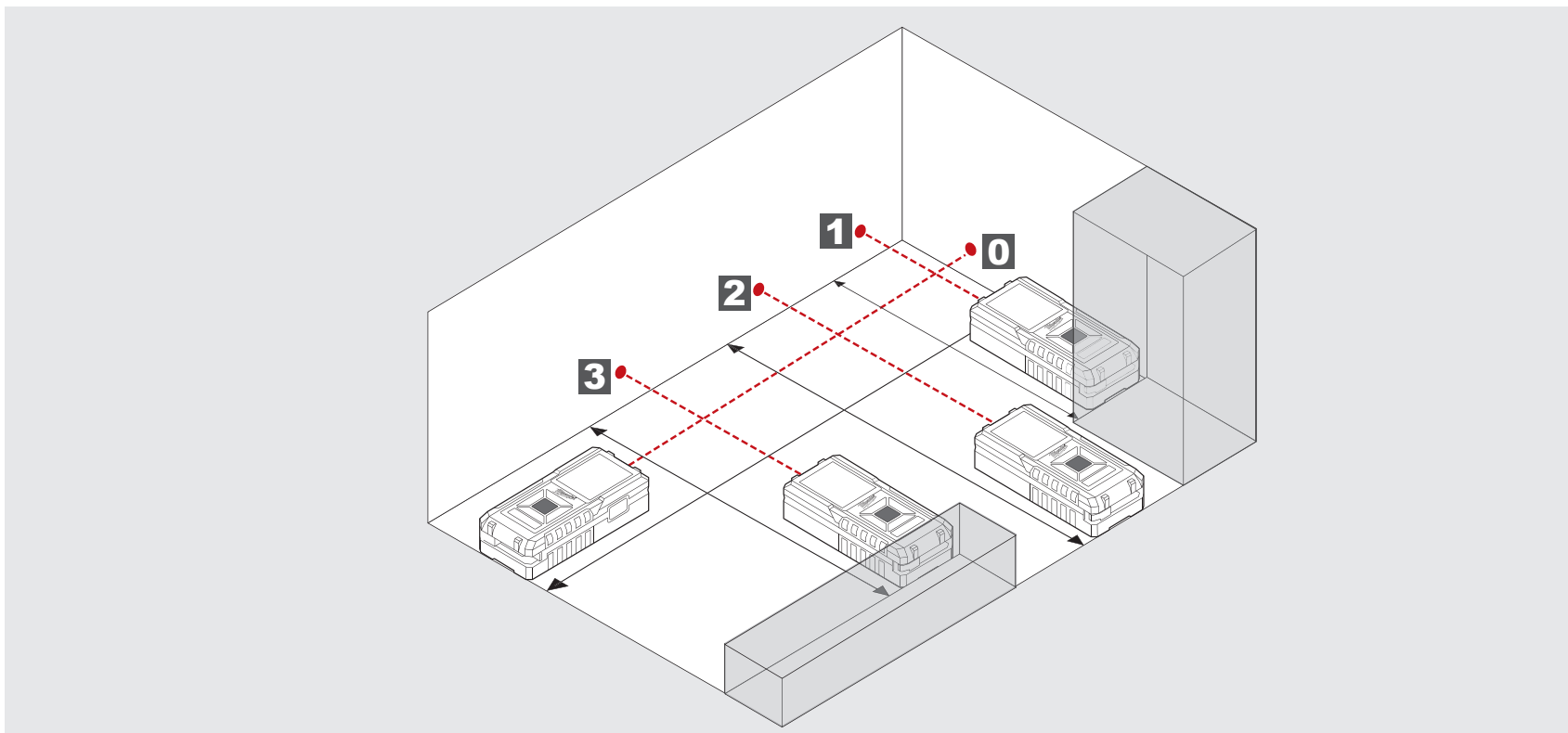

4

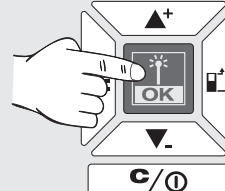
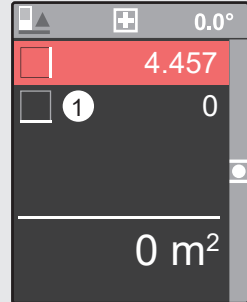
Neue Messung.
Ergebnis wird unter VERLAUF gespeichert.

VOLUMEN MESSEN

0

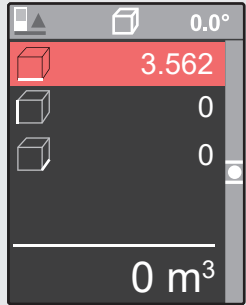

1

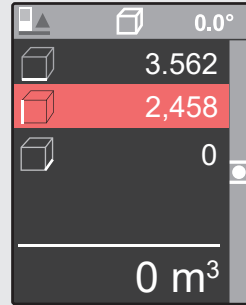
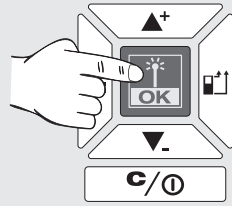

2

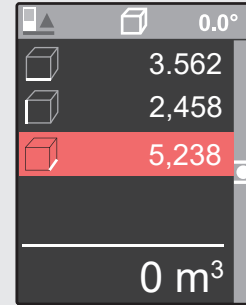
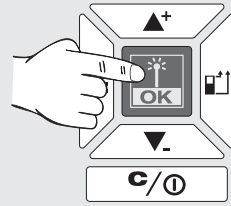

3

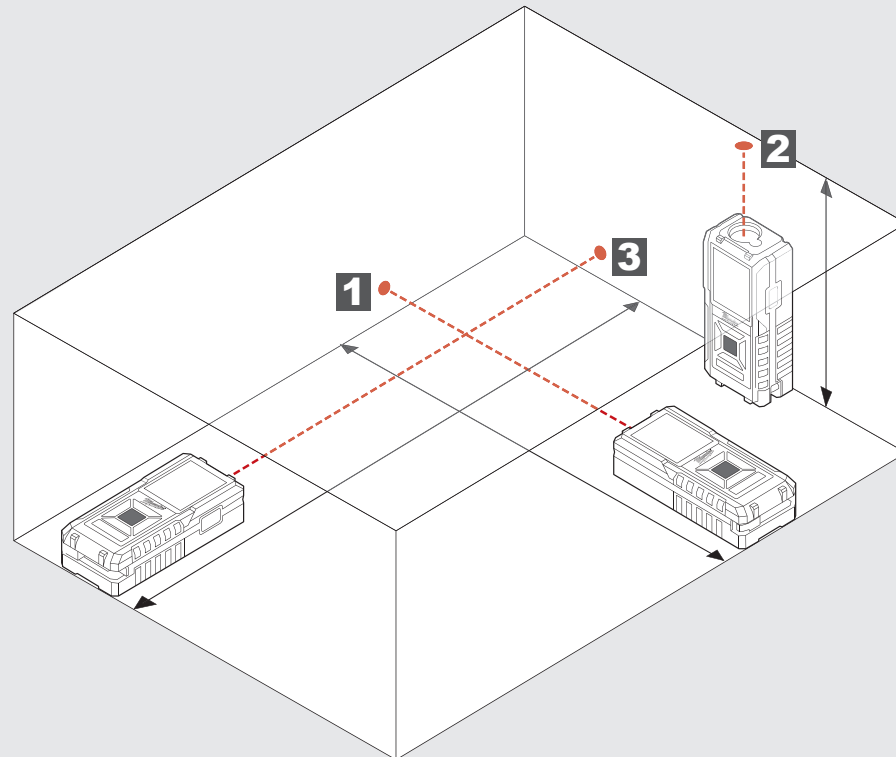
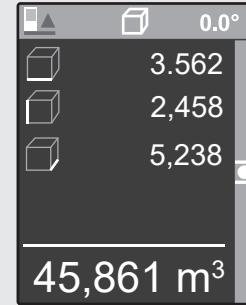
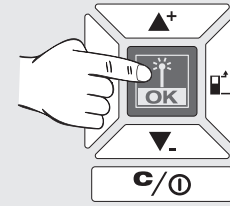

INDIREKTE HÖHEN-/LÄNGENMESSUNG (NUR MIT LDM 100)

0

1

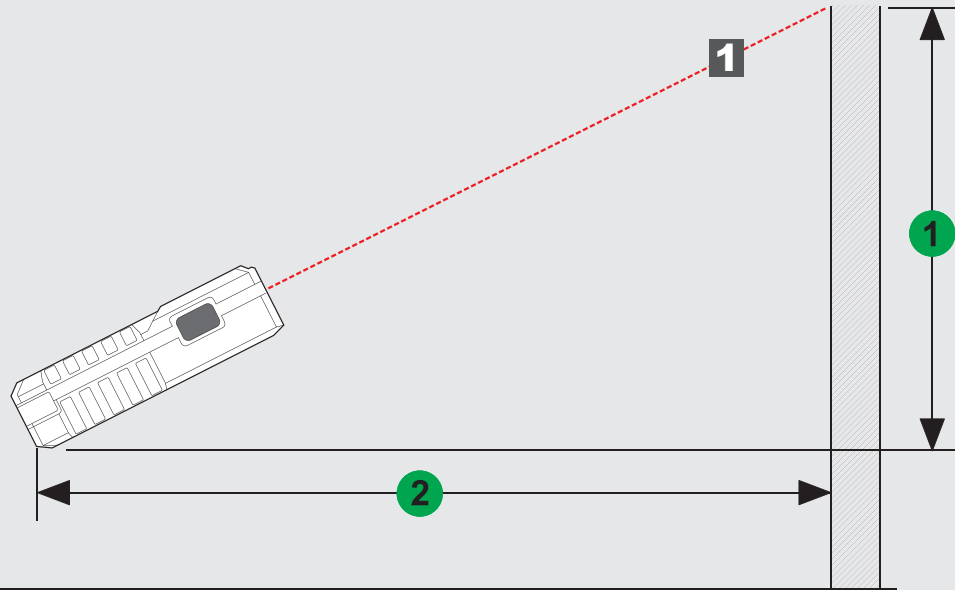
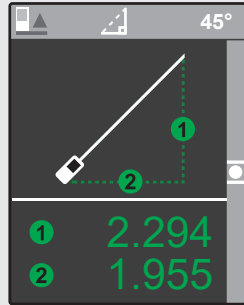
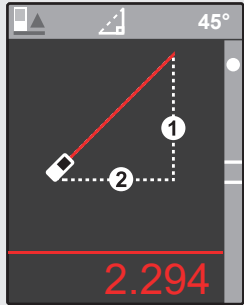
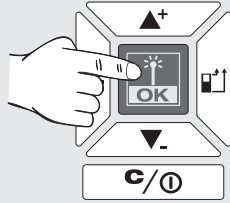

INDIREKTE HÖHENMESSUNG (NUR MIT LDM 100)

0

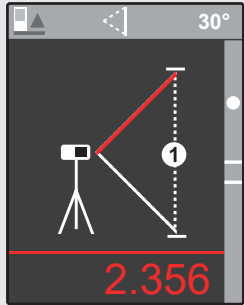

1

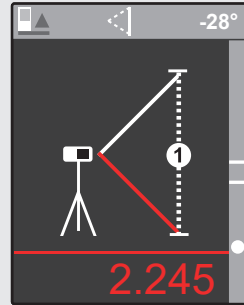
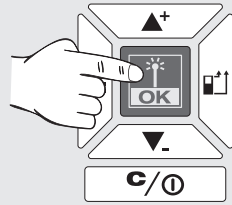

2

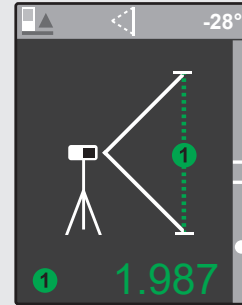
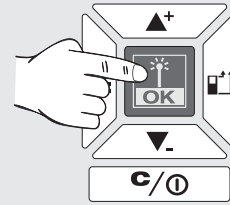

Verwenden Sie ein Stativ oder eine andere stabile Oberfläche, um zwei unterschiedliche Längen zu messen.

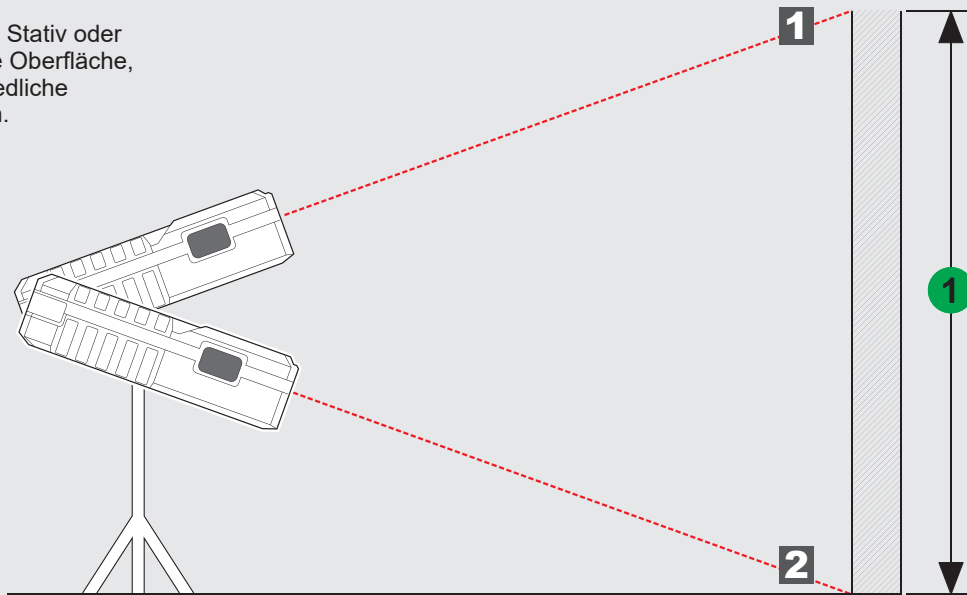

TABLE DES MATIÈRES

Consignes de sécurité importantes	1
Caractéristiques techniques	2
Utilisation conforme aux prescriptions.....	2
Tables codes erreurs	2
Aperçu	3
Menu.....	5
Démarrer	6
Mesure longueur.....	7
Mesure surface.....	8
Mesure surface totale.....	9
Mesure volume.....	10
Mesure indirect hauteur/longueur (seulement avec l'LDM 100) 11	
Mesure indirect hauteur (seulement avec l'LDM 100).....	12

CONSIGNES DE SÉCURITÉ IMPORTANTES



N'utilisez pas ce produit avant d'avoir lu les consignes de sécurité et le manuel de l'utilisateur chargés sur le CD joint.

Classement laser

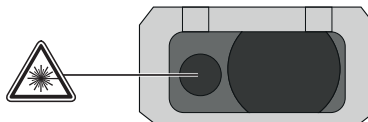

AVERTISSEMENT:

Ce produit fait partie de la classe laser 2 au sens de la norme CEI 60825-1:2007.



Avis :

Éviter tout contact visuel direct. Le rayon laser peut causer un aveuglement temporaire type flash aux yeux.

Ne regardez pas dans le faisceau laser et ne le dirigez pas inutilement sur d'autres personnes.

N'éblouissez pas d'autres personnes.

Avis :

Ne pas employer le dispositif au laser près des enfants et ne pas permettre aux enfants d'employer le dispositif au laser

Attention ! Des surfaces réfléchissantes pourraient réfléchir le rayon laser sur l'opérateur ou sur des autres personnes.

Se tenir à distance des pièces en mouvement.

Effectuez régulièrement des mesures d'essai, en particulier avant, pendant et après des mesures importantes.

Attention: si le produit est défectueux, est tombé, a été utilisé de manière non conforme ou modifié, il peut fournir des mesures incorrectes

Avis : L'utilisation d'éléments de contrôle, de sélections ou l'exécution de procédures différentes de celles établies par le guide pourra comporter une dangereuse exposition aux rayons.

Le dispositif de mesure laser a une plage d'application limitée. (Voir chapitre "Données techniques"). Tout essai de mesure hors de la plage max. ou min. produira des résultats imprécis. L'utilisation en présence de conditions atmosphériques défavorables, telles que températures très hautes ou très basses, lumière solaire très intense, pluie, neige, brouillard ou toute autre condition limitant la visibilité, pourra comporter des mesures imprécises.

Si le dispositif de mesure laser est déplacé d'un site chaud à un site froid (ou vice-versa) il faut attendre pour permettre au dispositif de s'adapter à la nouvelle température ambiante.

Conserver toujours le dispositif de mesure laser dans un endroit fermé et le protéger contre les chocs, les vibrations et les températures extrêmes.

Protéger le dispositif de mesure laser contre les poussières, les liquides et la haute humidité de l'air. Les facteurs susdits pourraient endommager gravement les composants internes ou influencer négativement sa précision.

Ne pas utiliser des détergents agressifs ou des solvants. Nettoyer uniquement avec un chiffon propre et doux.

Éviter de forts chocs sur le dispositif de mesure laser ou sa chute. Après une chute du dispositif de mesure laser ou après son exposition à d'autres sollicitations mécaniques, il est nécessaire de contrôler la précision du dispositif.

Les réparations éventuellement nécessaires sur le dispositif au laser sont à effectuer exclusivement par du personnel spécialisé autorisé !

N'utilisez pas le produit dans des zones à risque d'explosion ou dans des environnements agressifs.



Ne pas jeter les batteries déchargées avec les ordures ménagères. Les amener à un point de collecte prévu à cet effet pour une élimination conforme aux prescriptions

environnementales nationales ou locales. Ne pas jeter le produit avec les ordures ménagères. Éliminer le produit conformément aux prescriptions nationales en vigueur dans le pays d'utilisation. Suivre les règles de recyclage en vigueur sur le plan national, spécifiques au produit. Contactez les autorités locales ou le détaillant pour avoir des renseignements concernant la mise à la ferraille.

CE Marque CE

CARACTÉRISTIQUES TECHNIQUES

	LDM 45	LDM 100
Optique	15 mm x 9 mm	18 mm
Plage de mesure		
Distance min.	45 m (Tolérance: 45,1 m)	100 m (Tolérance: 101 m)
Distance max.	0,05 m	0,05 m
Mesure distance		
Tolérance typique (elle vaut pour 100 % de réflectivité de l'objectif (mur peint en blanc), bas éclairage de fond, 25 °C)	± 2,0 mm (il faudrait considérer une tolérance supplémentaire de 0,1 mm/m)	± 2,0 mm (il faudrait considérer une tolérance supplémentaire de 0,1 mm/m)
Tolérance max. (elle vaut pour des objectifs avec réflectivité plus basse, éclairage plus élevé de fond ou températures proches à la limite inférieure / supérieure)	± 4,0 mm (il faudrait considérer une tolérance supplémentaire de 0,15 mm/m)	± 4,0 mm (il faudrait considérer une tolérance supplémentaire de 0,15 mm/m)
Unité min. affichable	1,0 mm	1,0 mm
Grandeur point laser		
Distance 16 m:	25 x 50 mm	25 x 50 mm
Classe laser	2	2
Type laser	635 nm, < 1 mW	635 nm, < 1 mW
Rayon laser		
angle vertical	+1 degré	+1 degré
angle horizontal	±1 degré	±1 degré
Afficheur type	LCD (31,5 mm x 40 mm)	LCD (31,5 mm x 40 mm)
Coupure automatique laser	90 secondes	90 secondes
Coupure automatique dispositif	180 secondes	180 secondes
Alimentation	AAA 2x (batterie alcaline)	AAA 2x (batterie alcaline)
Durée batterie	8000 (mesures individuelles)	8000 (mesures individuelles)
Plage température d'utilisation	de -0°C à +40°C	de -0°C à +40°C
Plage température de stockage	de -10°C à +60°C	de -10°C à +60°C
Poids sans batterie	87 g	122 g
Classe de protection	IP54 (protection contre les poussières et les projections d'eau)	IP54 (protection contre les poussières et les projections d'eau)

UTILISATION CONFORME AUX PRESCRIPTIONS

Le dispositif de mesure laser est apte à mesurer des distances et des inclinaisons.
Comme déjà indiqué, cette machine n'est conçue que pour être utilisée conformément aux prescriptions.

TABLES CODES ERREURS

Code	Description	Solution
Err500	Problèmes matériel	Désactiver et réactiver le télémètre. Si le problème persiste, remettre le télémètre au centre d'assistance le plus proche.

APERÇU

BARRE D'ÉTAT

- ▶ Point de mesure de référence, Type de mesure, Angle de mesure (seulement avec LDM 100), Niveau de mesure (seulement avec LDM 100)

AFFICHEUR

- ▶ Menu
- ▶ Mesures
- ▶ Configurations

VERS LE HAUT / ADDITIONNER

- ▶ Défiler le menu vers le haut
- ▶ Additionner la valeur

MESURE / OK

- ▶ Activer le laser
- ▶ Sauvegarder la valeur mesurée
- ▶ Sélectionner OK dans le menu

MENU

- ▶ Historique
- ▶ Mesure
- ▶ Configurations

VERS LE BAS / SOUSTRAIRE

- ▶ Défiler le menu vers le bas
- ▶ Soustraire valeur

EFFACER/ACTIVER/DÉSACTIVER

- ▶ ON / OFF (appuyer sur la touche jusqu'à l'émission d'un signal acoustique)
- ▶ Effacer la valeur mesurée

POINT DE MESURE

- ▶ Postérieur (configuration défaut)
- ▶ Antérieur
- ▶ Angle (s'active automatiquement après la sortie de la pointe)

MESURE

- ▶ Activer le laser
- ▶ Sauvegarder la valeur mesurée

REPLACER LES BATTERIES

- ▶ Remplacer les batteries dès que le voyant de la batterie commence à clignoter.

1

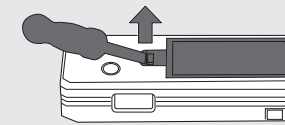

2

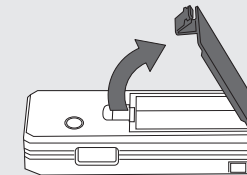

3

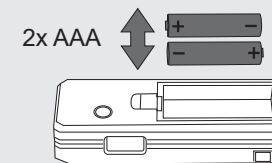

4

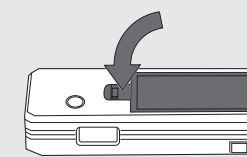

CHEVALET

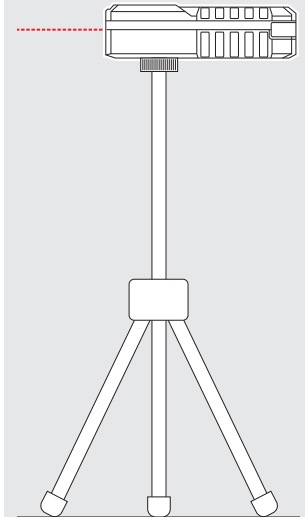

POINTE POUR COINS

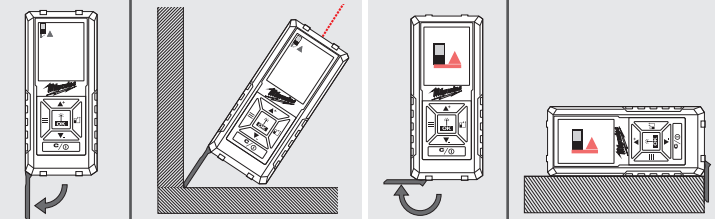

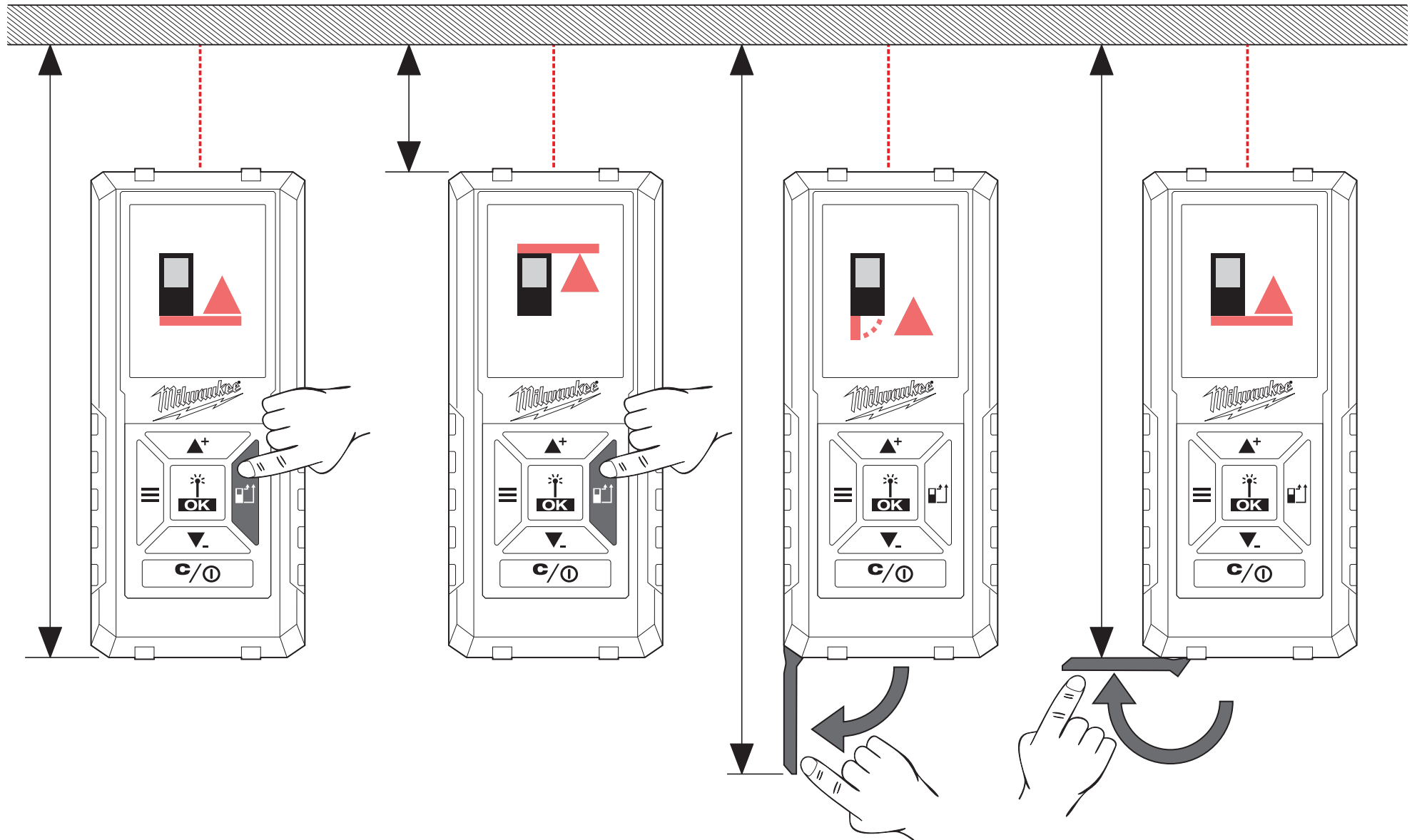

MENU

HISTORIQUE



Affichage des dernières 30 mesures / calculs

Chaque mesure effectuée pour le calcul de la surface, de la surface totale, du volume, etc. n'est pas sauvegardée dans l'HISTORIQUE, mais le système sauvegarde uniquement le résultat des calculs.

Pour effacer une donnée, appuyer sur la touche C/ON/OFF.

Aux/des valeurs sauvegardées dans l'HISTORIQUE, il est possible d'additionner ou de soustraire des mesures / calculs. Uniquement des calculs de même type pourront être effectués (longueur, surface, volume, etc.).

Pour effectuer le calcul :

1. Utiliser les touches ▲+ ▼_ pour sélectionner le mode de mesure dans l'HISTORIQUE.
2. Appuyer sur la touche OK.
3. Effectuer les mesures nécessaires au calcul.
4. Appuyer sur la touche OK pour sauvegarder le nouveau calcul dans l'HISTORIQUE.

MESURE

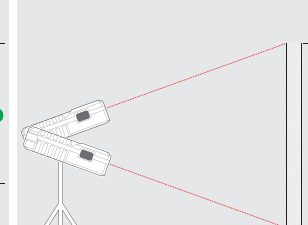
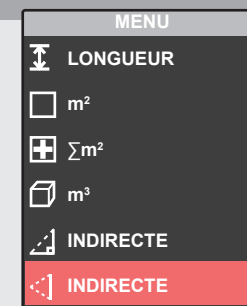
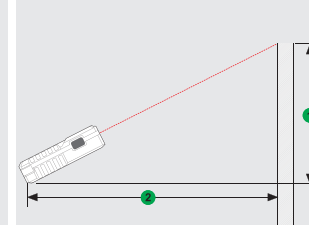
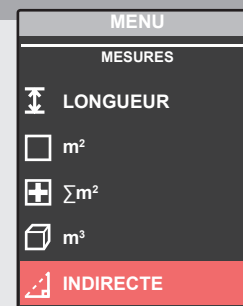
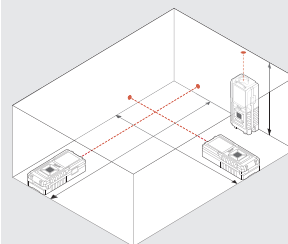
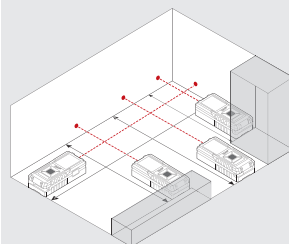
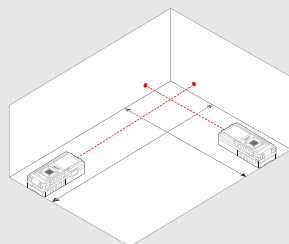
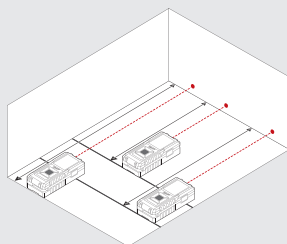

CONFIGURATIONS

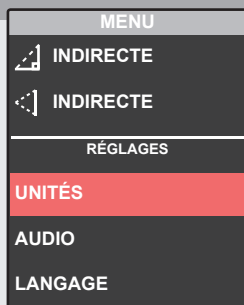

Sélectionner l'unité de mesure souhaitée.

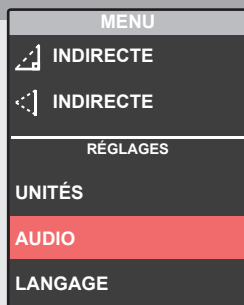



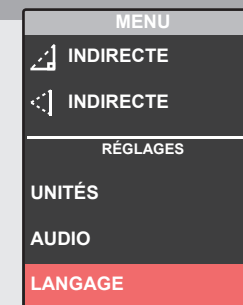

Signal acoustique ON/OFF.

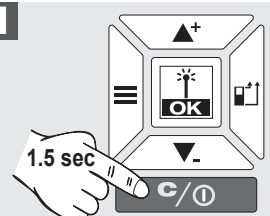
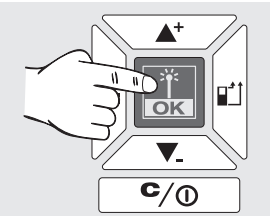
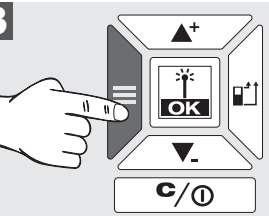
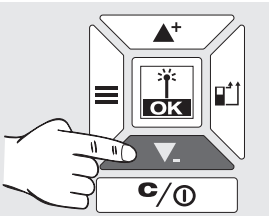
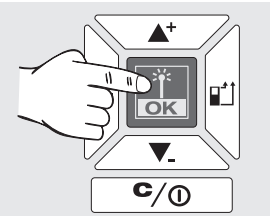

Sélectionner la langue

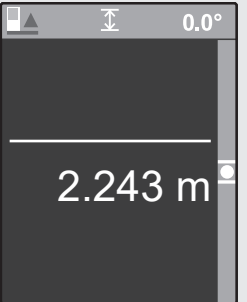
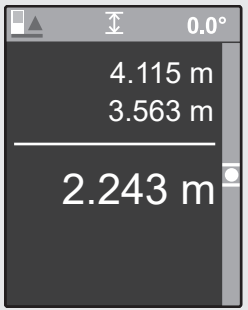
DÉMARRER

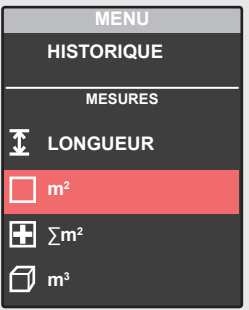
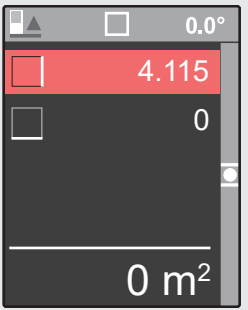
1  <p>1.5 sec</p>	2 	3 	4 	5 
 				
<p>Lors de l'activation, LE MODE DE MESURE LONGUEUR sera activé automatiquement.</p>	<p>Effectuer une MESURE DE LONGUEUR ou ...</p>	<p>... appuyer sur la touche menu pour passer au menu ...</p>	<p>... et sélectionner un autre mode de fonctionnement à l'aide des touches ▲+ ▼_ et ...</p>	<p>... activer ce mode de fonctionnement en appuyant sur la touche OK.</p>

MESURE LONGUEUR

0

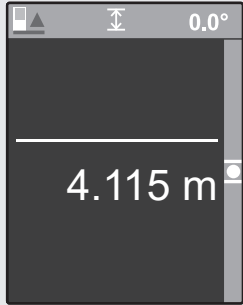

Valeur de mesure blanche =
valeur mesurée

1

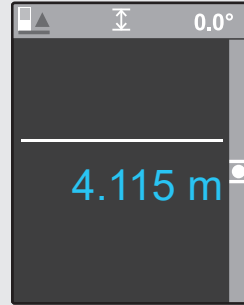
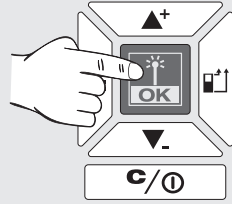

Valeur de mesure bleue =
sauvegardée temporairement

2

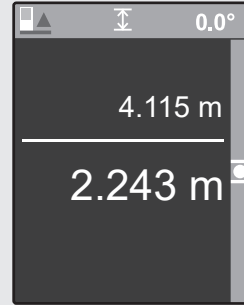
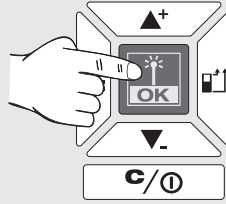

3

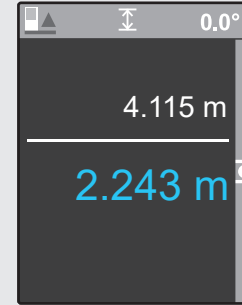
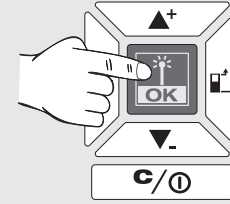

4

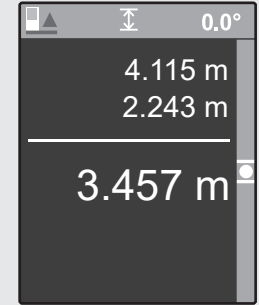
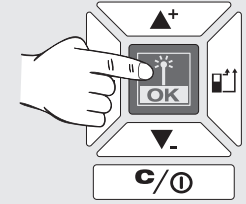

5

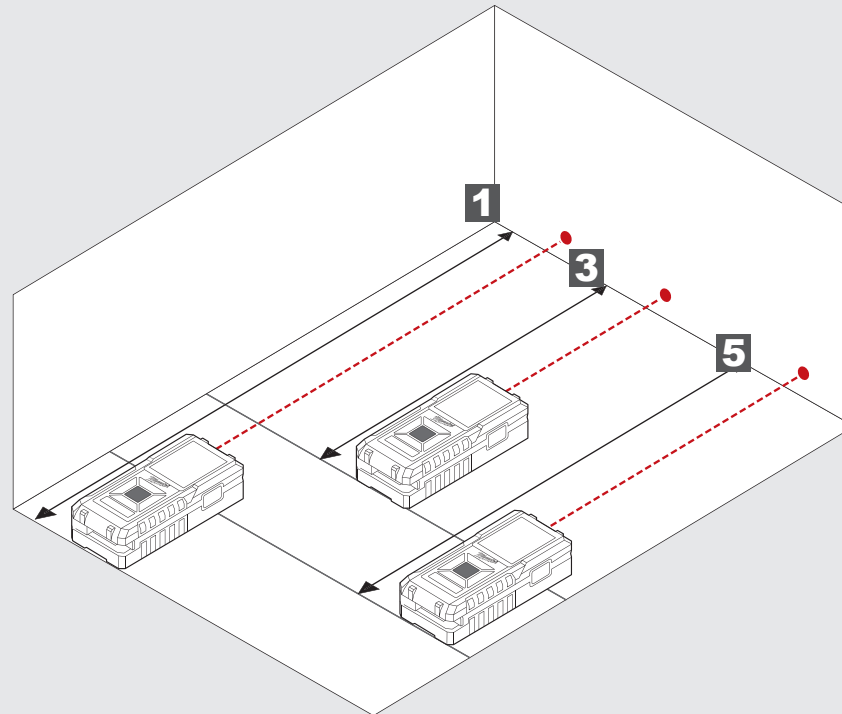
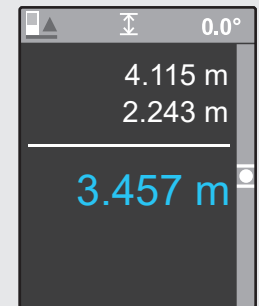
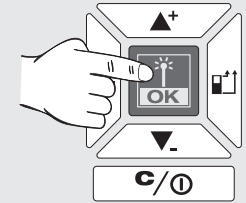

MESURE SURFACE

0

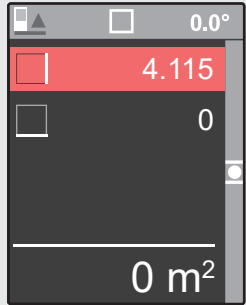

1

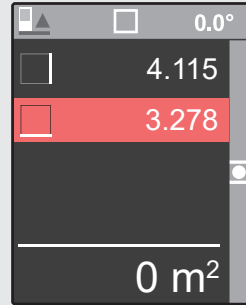
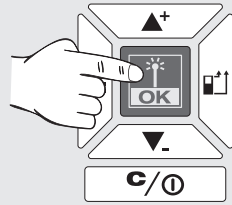

2

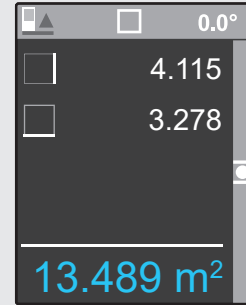
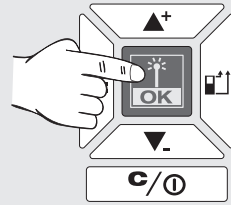

2

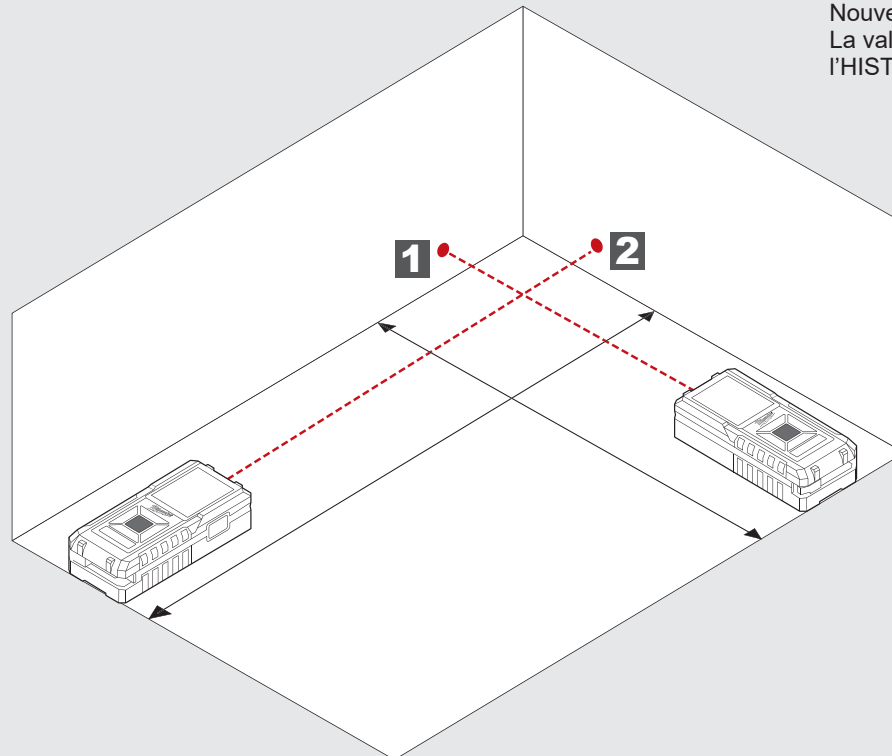
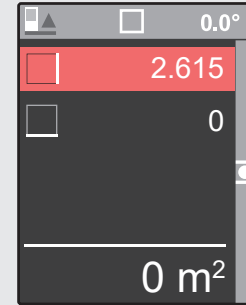
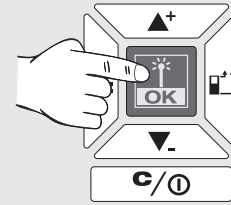

Nouvelle mesure
La valeur sera sauvegardée dans
l'HISTORIQUE

MESURE SURFACE TOTALE

0

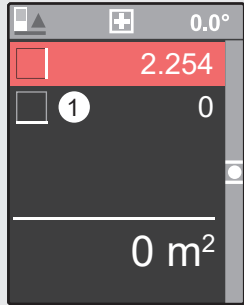

1

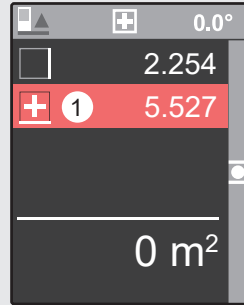
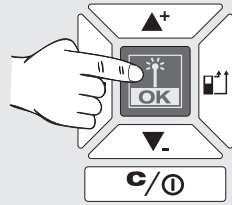

2

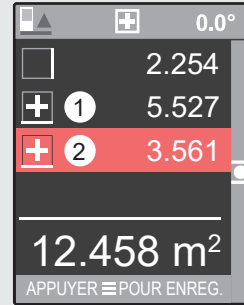
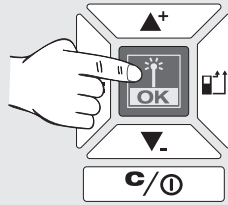

3

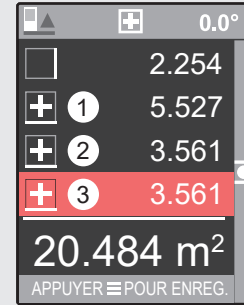
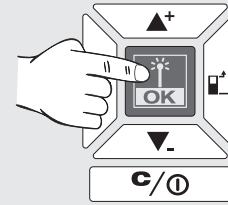

4

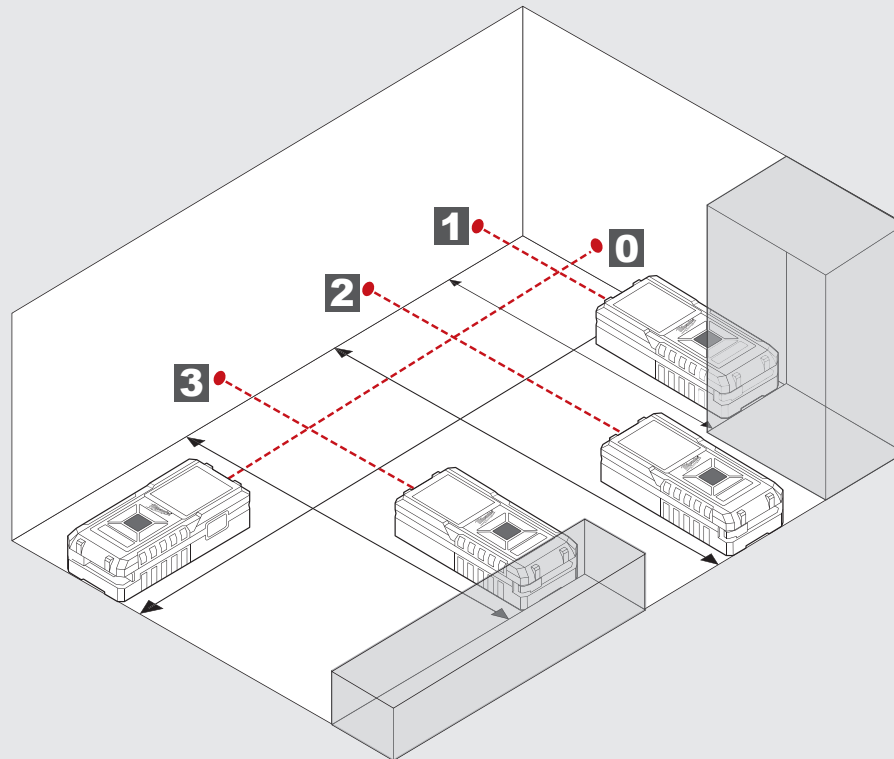
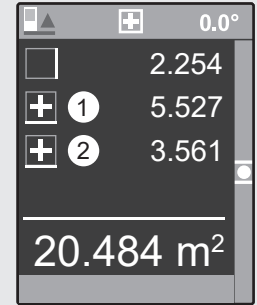
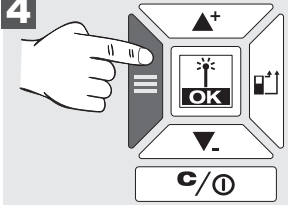

4

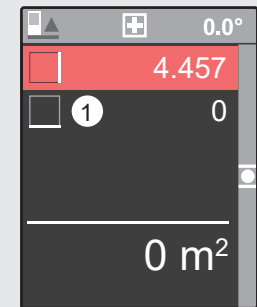
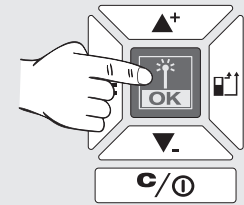

Nouvelle mesure
Le résultat sera sauvegardé dans l'HISTORIQUE

MESURE VOLUME

0

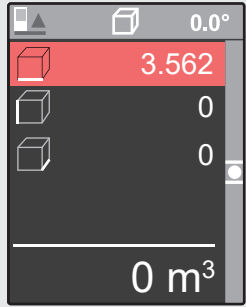

1

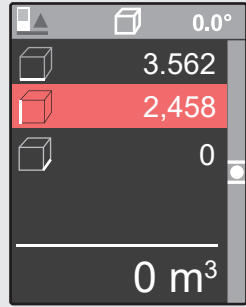
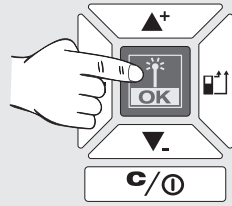

2

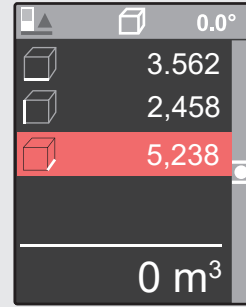
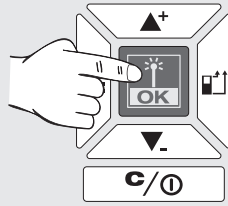

3

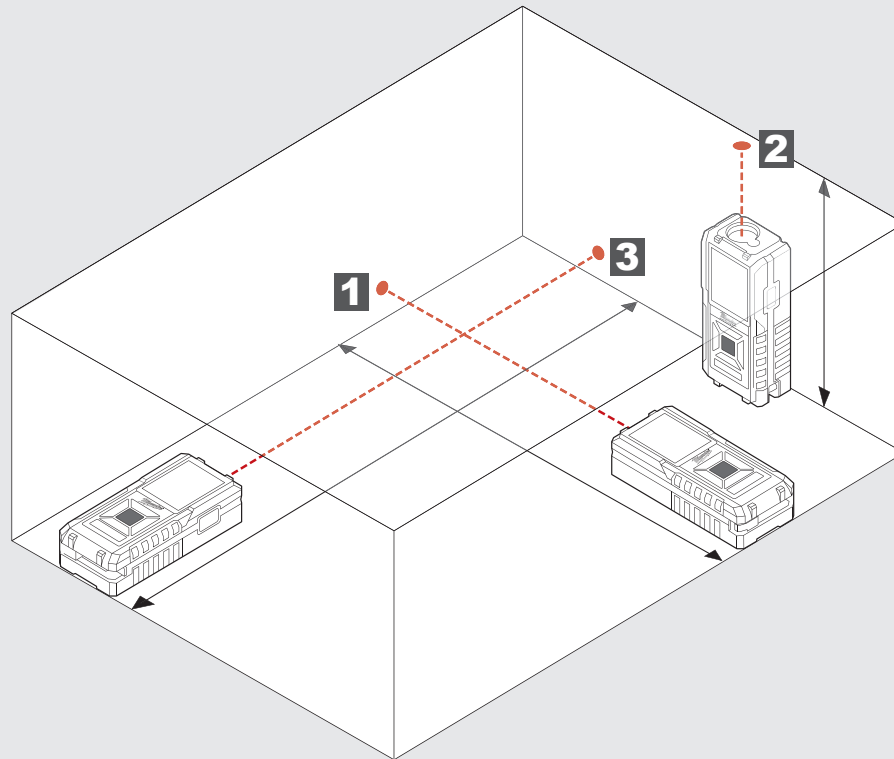
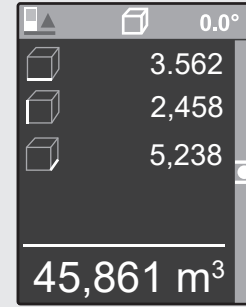
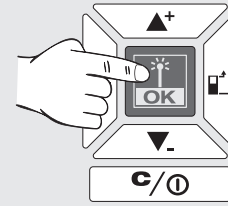

MESURE INDIRECT HAUTEUR/LONGUEUR (SEULEMENT AVEC L'LDM 100)

0

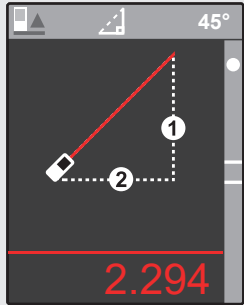

1

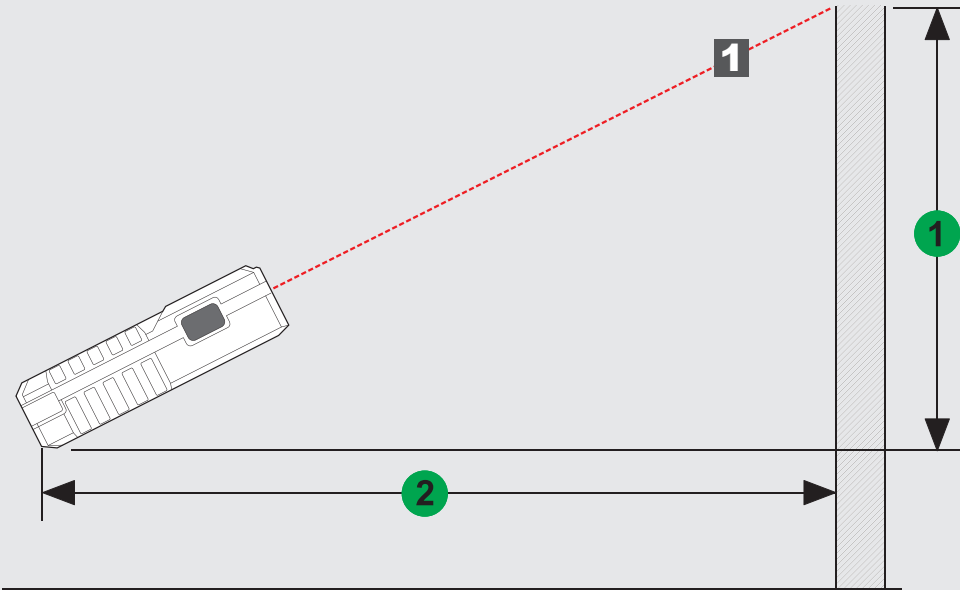
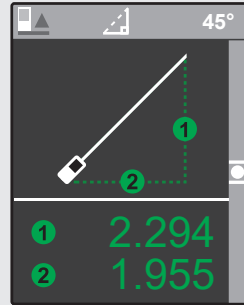
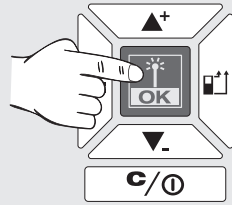

MESURE INDIRECT HAUTEUR (SEULEMENT AVEC L'LDM 100)

0

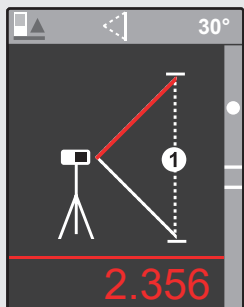

1

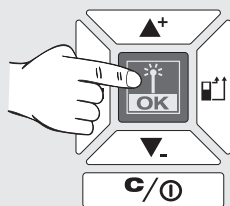

2

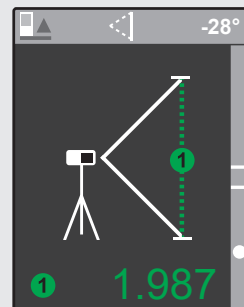
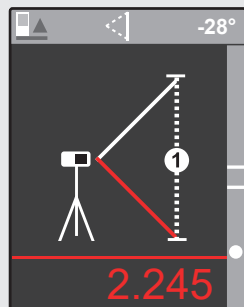
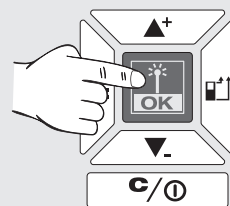

Utiliser le chevalet ou une autre surface stable pour mesurer deux longueurs différentes.

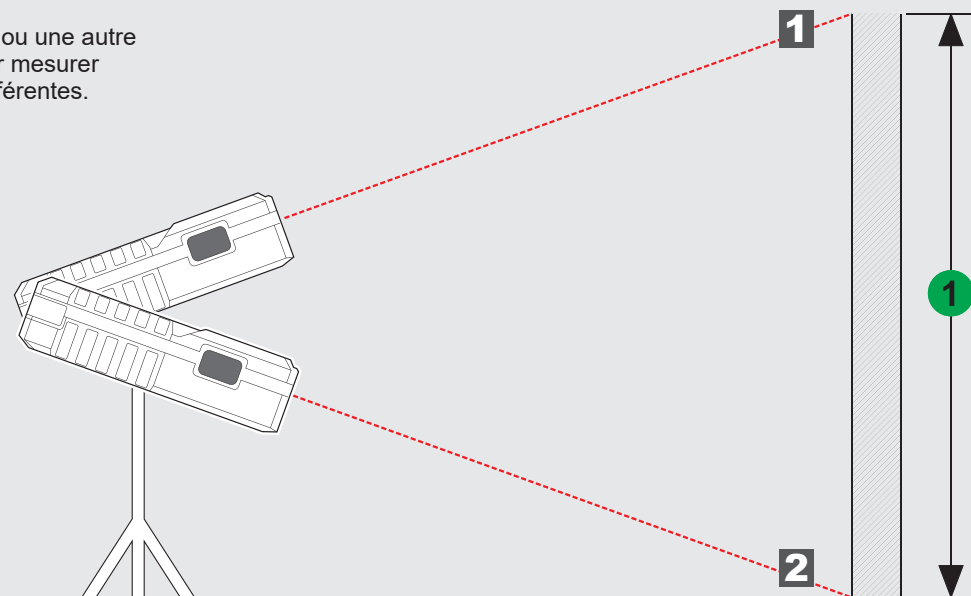

INDICE

Importanti istruzioni di sicurezza	1
Dati tecnici	2
Utilizzo conforme	2
Tabella codici errori	2
Panoramica	3
Punto di misurazione	4
Menu	5
Inizia	6
Misurazione lunghezza	7
Misurazione superficie	8
Misurazione superficie complessiva	9
Misurazione volume	10
Misurazione indiretta altezza/lunghezza (solo con l'LDM 100)	11
Misurazione indiretta altezza (solo con l'LDM 100)	12

IMPORTANTI ISTRUZIONI DI SICUREZZA



Non usare il prodotto prima di avere studiato le Istruzioni di sicurezza e il Manuale d'uso sul CD in allegato.

Classifica laser

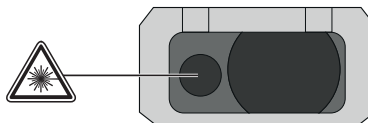

AVVERTENZA:

Si tratta di un prodotto laser di classe 2 conforme a EN60825-1:2014



Avvertenza:

Evitare qualsiasi contatto visivo diretto. Il raggio laser può causare un accecamento temporaneo da flash agli occhi.

Non fissare il raggio laser né puntarlo verso altri senza motivo.

Non abbagliare altre persone.

Avvertenza:

Non usare il dispositivo a laser nelle vicinanze di bambini e non permettere ai bambini di usare il dispositivo a laser.

Attenzione! Superfici riflettenti potrebbero fare riflettere il raggio laser sull'operatore o su altre persone.

Tenere le estremità a una distanza di sicurezza.

Effettuare periodicamente delle misure di controllo, soprattutto prima, durante e dopo misurazioni di particolare importanza.

Se il prodotto è difettoso, è caduto, è stato usato in modo improprio o modificato potrebbe fornire misurazioni errate.

Avvertenza: L'uso di elementi di controllo, di impostazioni oppure l'esecuzione di procedimenti diversi da quelli stabiliti nel manuale può comportare una pericolosa esposizione ai raggi.

Il dispositivo di misura a laser ha un range di applicazione limitato. (Vedi il capitolo Dati tecnici). Tentativi di misurare al di fuori del range massimo e minimo causano imprecisioni. L'uso in presenza di condizioni atmosferiche avverse, come temperature eccessivamente alte o basse, luce solare molto intensa, pioggia, neve, nebbia o altre condizioni che limitano la visibilità, può comportare misurazioni imprecise.

Se il dispositivo di misura a laser viene portato da un ambiente caldo in un ambiente freddo (o vice-versa), attendere che il dispositivo si adatti alla nuova temperatura ambiente.

Conservare il dispositivo di misura a laser sempre in ambienti chiusi, proteggerlo da urti, vibrazioni e temperature estreme.

Proteggere il dispositivo di misura a laser da polveri, liquidi ed elevata umidità dell'aria. I suddetti fattori potrebbero danneggiare gravemente i componenti interni o influenzare negativamente la precisione.

Non usare detergenti aggressivi o solventi. Pulire soltanto con un panno pulito, morbido.

Evitare forti urti sul dispositivo di misura a laser o la sua caduta. Dopo una caduta del dispositivo di misura a laser o dopo una sua esposizione ad altre sollecitazioni meccaniche è necessario verificare la precisione del dispositivo.

Le riparazioni eventualmente necessarie sul dispositivo a laser devono essere eseguite esclusivamente da personale specializzato autorizzato!

Non azionare il prodotto in aree a rischio di esplosione o in ambienti aggressivi.



Non smaltire le batterie scariche assieme ai rifiuti domestici. Al fine di garantire il rispetto dell'ambiente smaltirle presso i punti di raccolta esistenti secondo quanto previsto dalle disposizioni nazionali o locali. Non smaltire il prodotto assieme ai rifiuti domestici, altire il prodotto correttamente, nel rispetto delle normative vigenti nel paese d'uso. Attenersi alle norme nazionali e locali vigenti in materia. Contattare le autorità locali o il rivenditore per ottenere informazioni sullo smaltimento.



Marchio CE

DATI TECNICI

	LDM 45	LDM 100
Ottica	15 mm x 9 mm	18 mm
Gamma di misura		
Distanza minima	45 m (Tolleranza: 45,1 m)	100 m (Tolleranza: 101 m)
Distanza massima	0,05 m	0,05 m
Misurazione distanza		
Tolleranza tipica (vale per 100 % di riflettanza dell'obiettivo (parete verniciata bianca), bassa illuminazione dello sfondo, 25 °C)	± 2,0 mm (si dovrebbe considerare una tolleranza aggiuntiva di 0,1 mm/m)	± 2,0 mm (si dovrebbe considerare una tolleranza aggiuntiva di 0,1 mm/m)
Tolleranza massima (vale per obiettivi con riflettanza minore, elevata illuminazione dello sfondo o temperature vicine al limite inferiore/superiore)	± 4,0 mm (si dovrebbe considerare una tolleranza aggiuntiva di 0,15 mm/m)	± 4,0 mm (si dovrebbe considerare una tolleranza aggiuntiva di 0,15 mm/m)
Unità minima visualizzabile	1,0 mm	1,0 mm
Grandezza punto laser		
Distanza 16 m:	25 x 50 mm	25 x 50 mm
Classe laser	2	2
Tipo laser	635 nm, < 1 mW	635 nm, < 1 mW
Raggio laser		
angolo verticale	+1 grado	+1 grado
angolo orizzontale	±1 grado	±1 grado
Display tipo	LCD (31,5 mm x 40 mm)	LCD (31,5 mm x 40 mm)
Disattivazione automatica laser	90 secondi	90 secondi
Disattivazione automatica dispositivo	180 secondi	180 secondi
Alimentazione	AAA 2x (batteria alcalina)	AAA 2x (batteria alcalina)
Durata batteria	8000 (misurazione singola)	8000 (misurazione singola)
Range temperatura di lavoro	da -0°C a +40°C	da -0°C a +40°C
Range temperatura di immagazzinaggio	da -10°C a +60°C	da -10°C a +60°C
Peso senza batteria	87 g	122 g
Classe di protezione	IP54 (protezione da polveri e spruzzi d'acqua)	IP54 (protezione da polveri e spruzzi d'acqua)

UTILIZZO CONFORME

Il dispositivo di misura a laser è atto a misurare distanze ed inclinazioni.
Utilizzare il prodotto solo per l'uso per cui è previsto.

TABELLA CODICI ERRORI

Codice	Descrizione	Soluzione
Err500	Problemi hardware	Spegnere e riaccendere il misuratore. Se il problema persiste, portare il misuratore al più vicino centro di assistenza.

PANORAMICA

BARRA DI STATO

- ▶ Punto misurazione di riferimento, Tipo di misurazione, Angolo di misurazione (solo con LDM 100), Livello di misurazione (solo con LDM 100)

DISPLAY

- ▶ Menu
- ▶ Misurazioni
- ▶ Impostazioni

VERSO SU / SOMMARE

- ▶ Andare verso su nel menu
- ▶ Sommare il valore

MISURAZIONE / OK

- ▶ Accendi il laser
- ▶ Salva il valore misurato
- ▶ Seleziona OK nel menu

MENU

- ▶ Storico
- ▶ Misurazione
- ▶ Impostazioni

VERSO GIÙ / SOTTRARRE

- ▶ Andare verso giù nel menu
- ▶ Sottrai valore

CANCELLA/ACCENDI/SPEGNI

- ▶ ON / OFF (tenere premuto il tasto fino a quando il dispositivo non emetterà un segnale acustico)
- ▶ Cancella il valore misurato

PUNTO DI MISURAZIONE

- ▶ Posteriore (impostazione default)
- ▶ Anteriore
- ▶ Angolo (si attiva automaticamente estraendo la punta)

MISURA

- ▶ Accendi il laser
- ▶ Salva il valore misurato

SOSTITUISCI LE BATTERIE

- ▶ Sostituire le batterie non appena il simbolo della batteria inizia a lampeggiare.

1

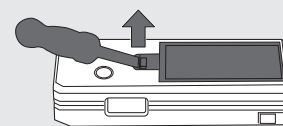

2

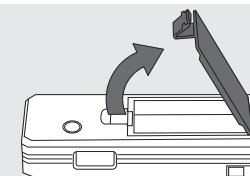

3

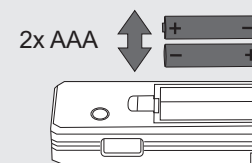

4

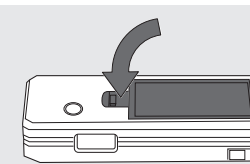

CAVALLETTO

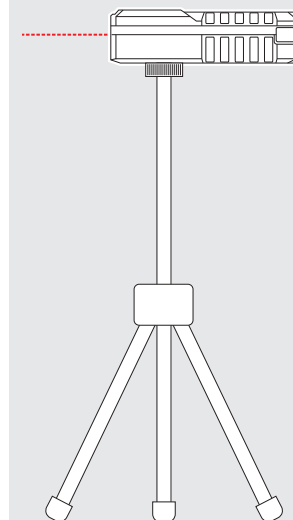

PUNTA PER ANGOLI

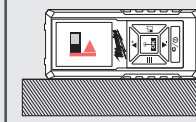
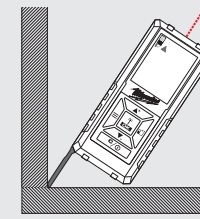

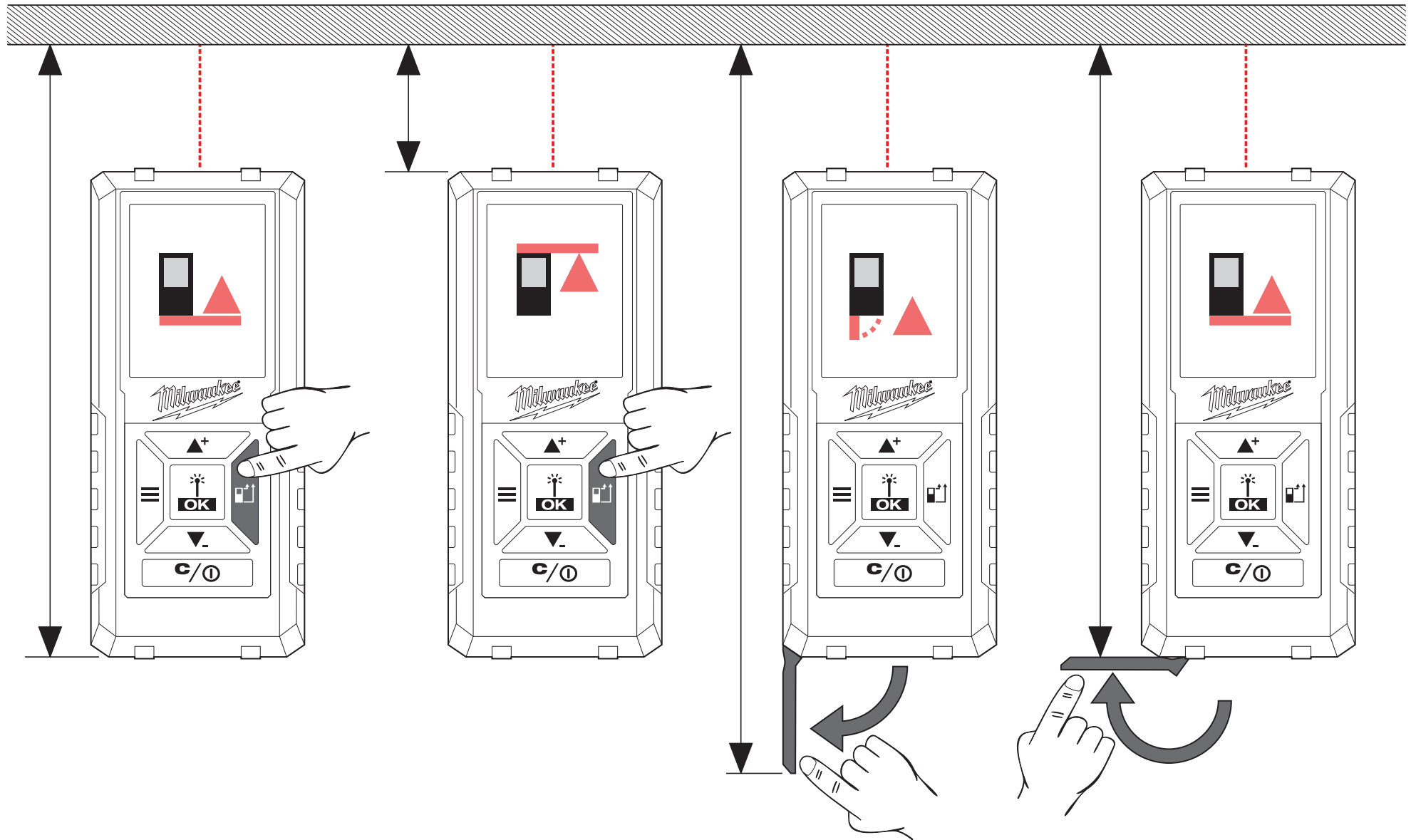

MENU

STORICO



Visualizzazione delle ultime 30 misurazioni / calcoli

Le singole misurazioni effettuate per il calcolo di superficie, superficie complessiva, volume, ecc. non vengono salvate nello STORICO, ma soltanto il risultato dei calcoli.

Per cancellare un dato, premere il tasto C/ON/OFF.

Ai/dai valori salvati nello STORICO è possibile sommare o sottrarre misurazioni/calcoli. Possono essere eseguiti soltanto calcoli dello stesso tipo (lunghezza, superficie, volume, ecc.).

Per eseguire un calcolo:

1. Usa i tasti ▲+ ▼- per selezionare una modalità di misurazione dallo STORICO.
2. Premi il tasto OK.
3. Esegui le misurazioni necessarie al calcolo.
4. Premi il tasto OK per salvare il nuovo calcolo nello STORICO.

MISURAZIONE

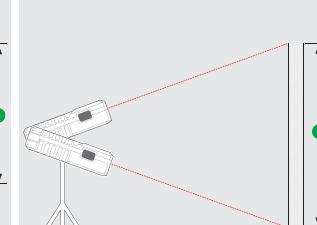
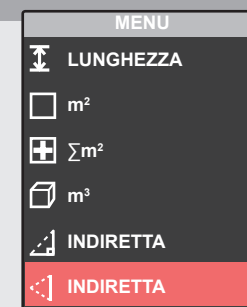
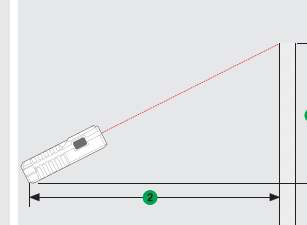
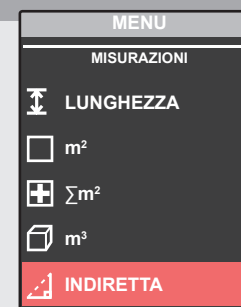
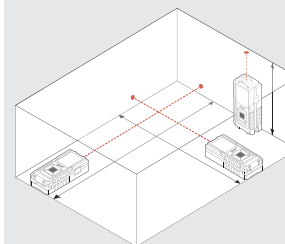
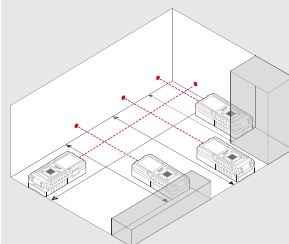
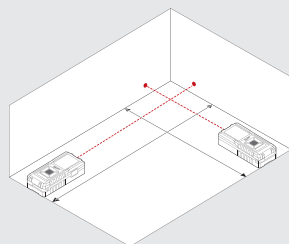
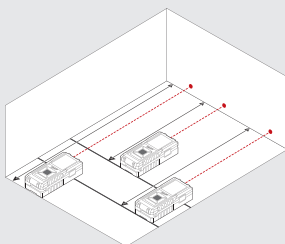

IMPOSTAZIONI



Seleziona l'unità di misura desiderata.



Segnale acustico ON/OFF.



Seleziona la lingua

INIZIA

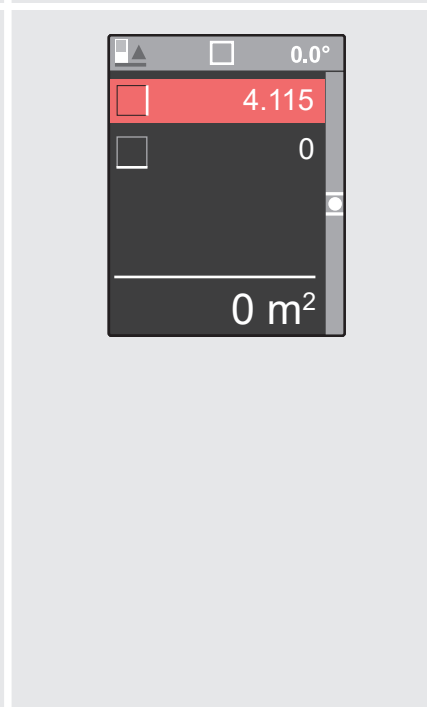
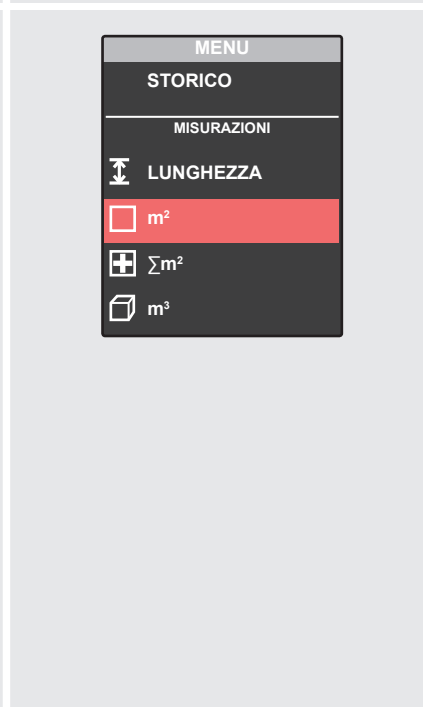
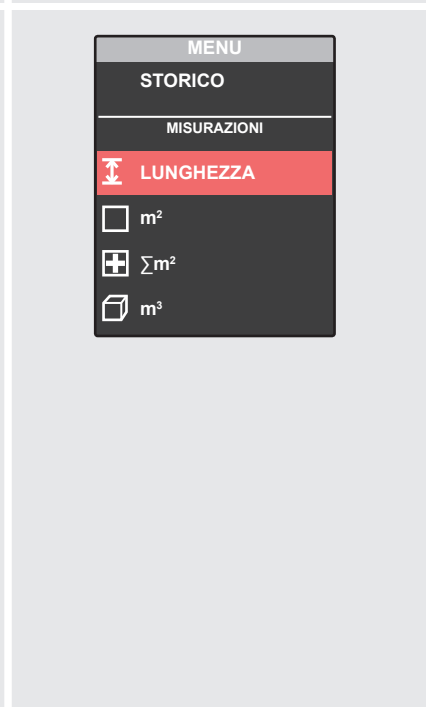
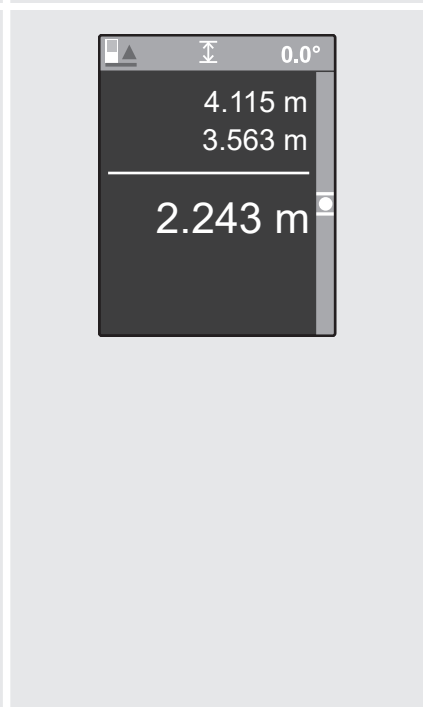
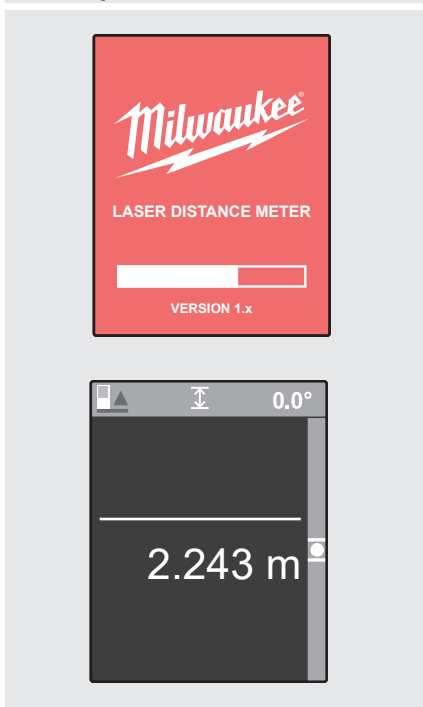
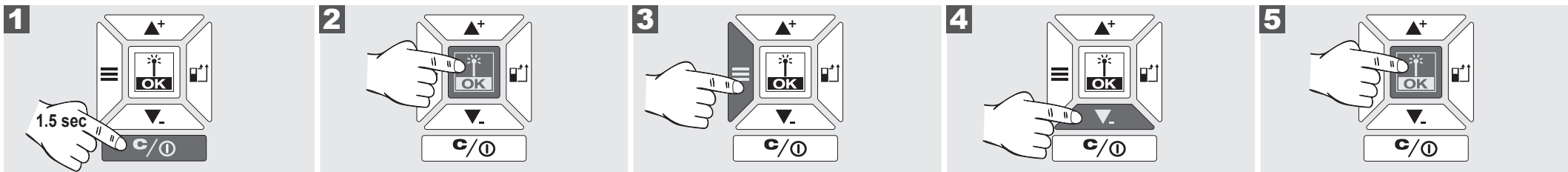

All'accensione viene attivata automaticamente la MODALITÀ DI MISURAZIONE LUNGHEZZA.

Esegui una MISURAZIONE DI LUNGHEZZA oppure ...

... premi il tasto menu per passare al menu ...

... e seleziona un'altra modalità di funzionamento con i tasti ▲⁺ ▼₋ e ...

... attiva questa modalità di funzionamento premendo il tasto OK.

MISURAZIONE LUNGHEZZA

0

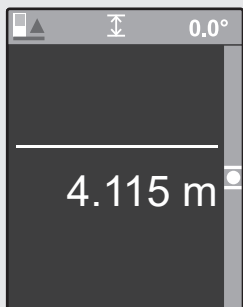

Valore di misurazione bianco =
valore misurato

1

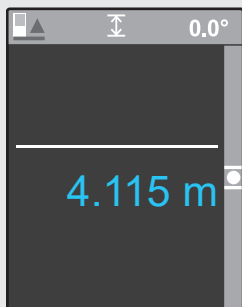
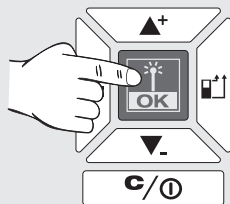

Valore di misurazione blu = salvato
provvisoriamente

2

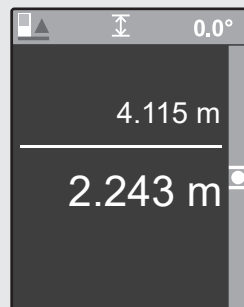
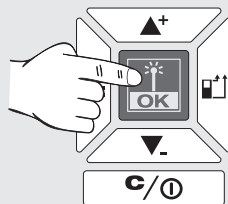

3

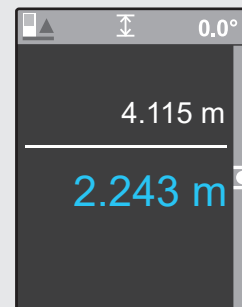
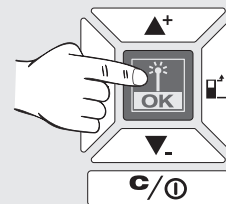

4

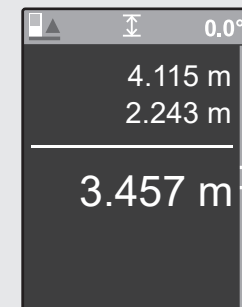
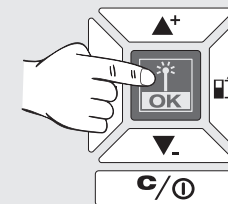

5

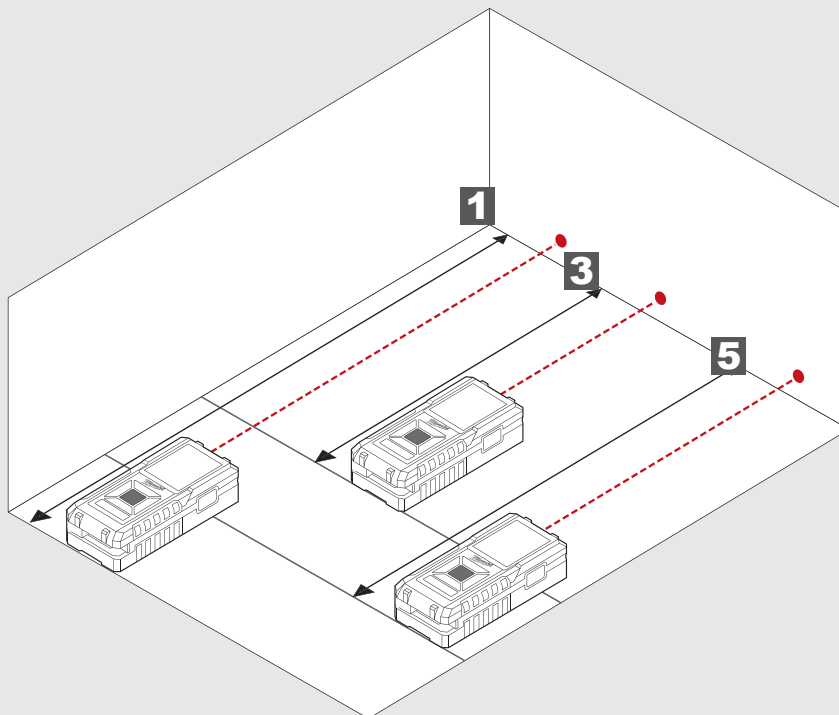
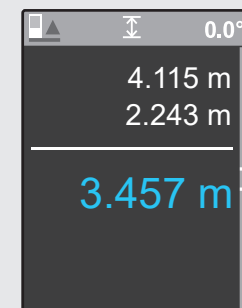
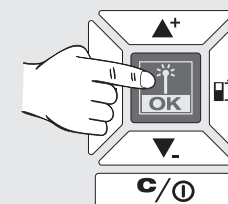

MISURAZIONE SUPERFICIE

0

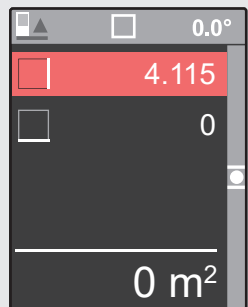

1

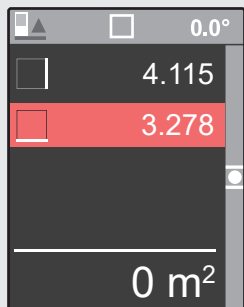
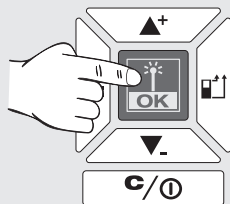

2

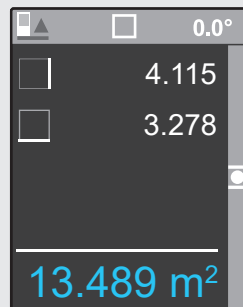
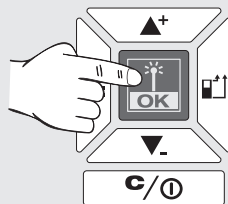

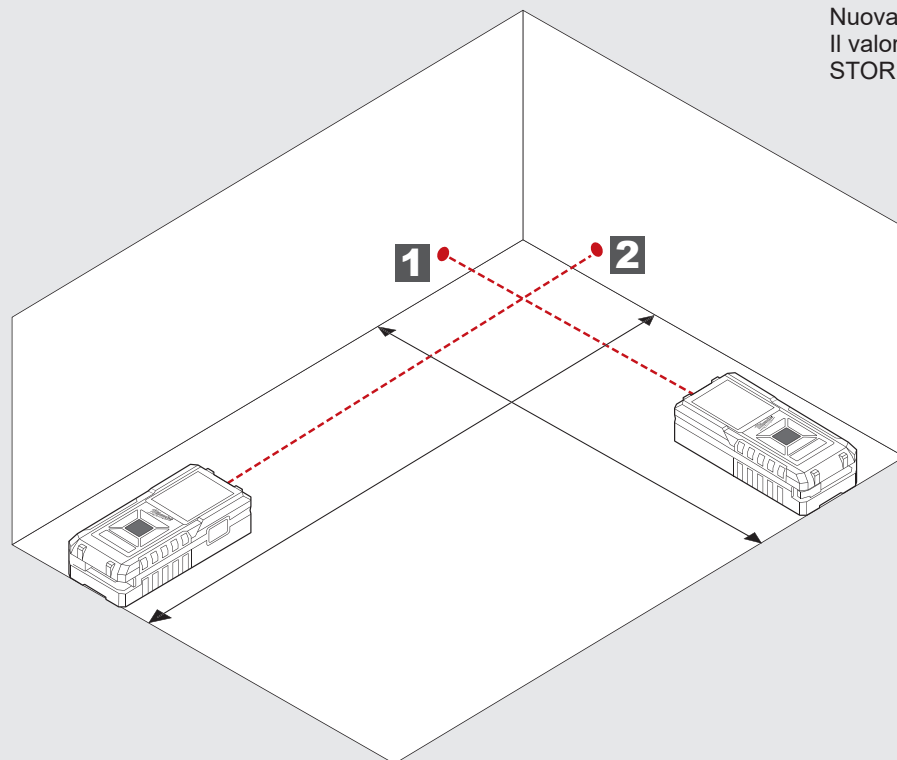
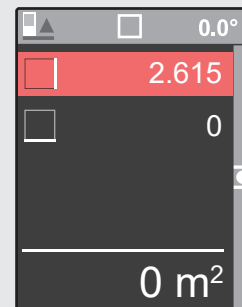
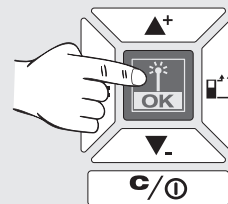

2

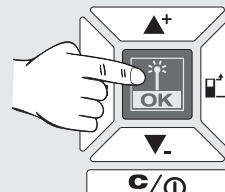
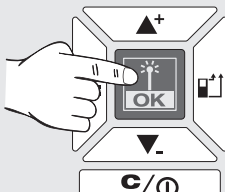
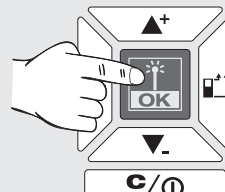
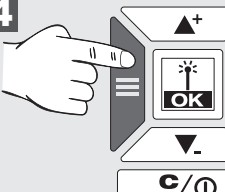

Nuova misurazione
Il valore viene salvato nello
STORICO

MISURAZIONE SUPERFICIE COMPLESSIVA

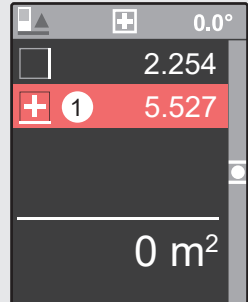
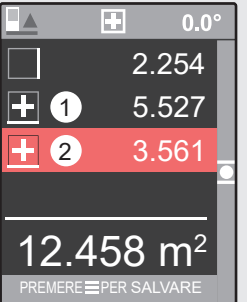
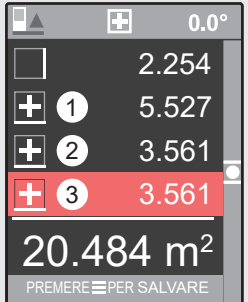
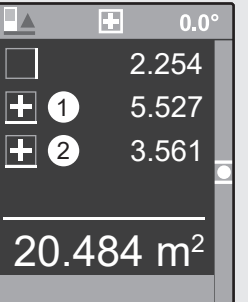
0	1 	2 	3 	4 
				

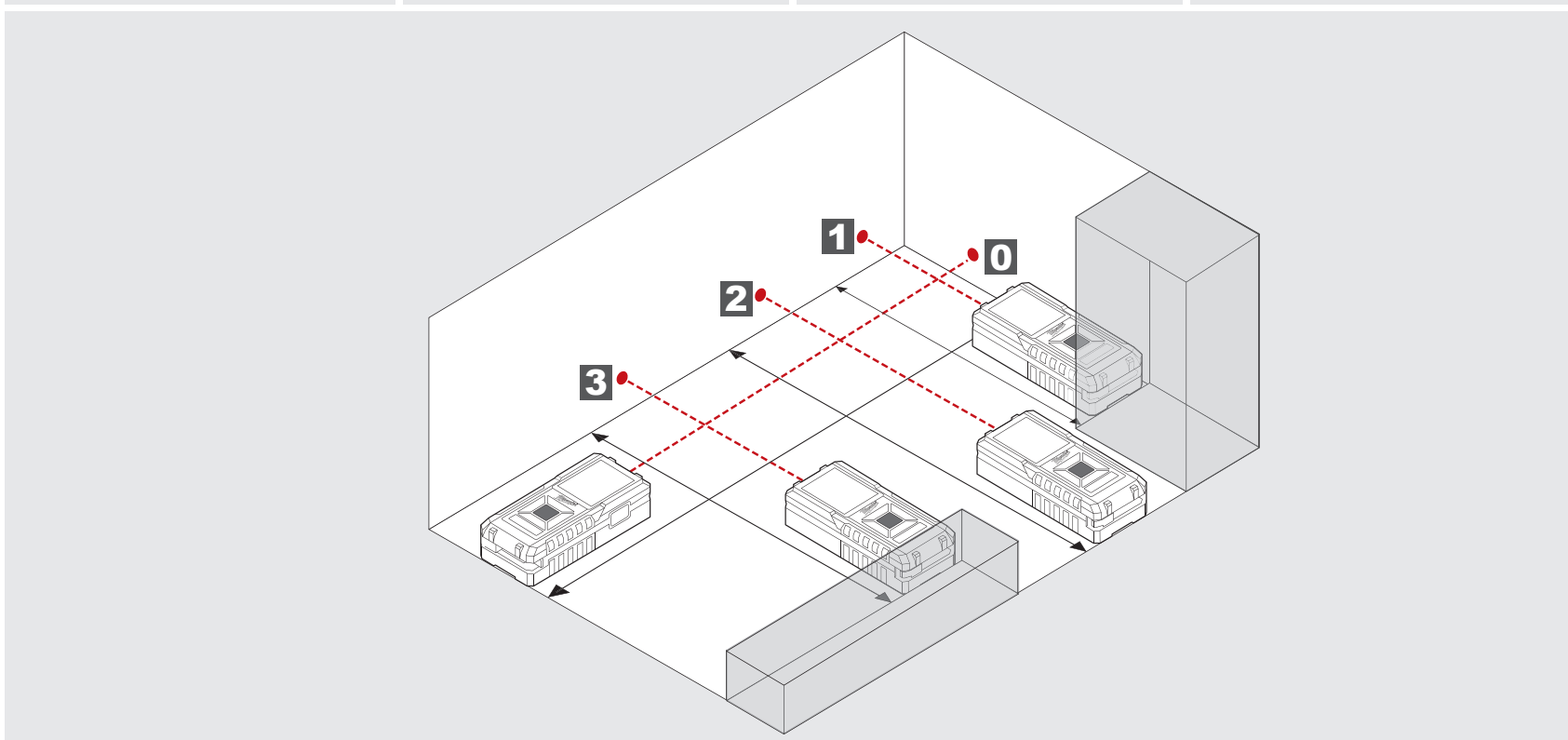

4





Nuova misurazione
Il risultato viene salvato nello
STORICO

MISURAZIONE VOLUME

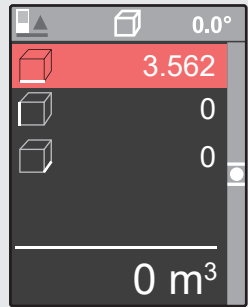
0

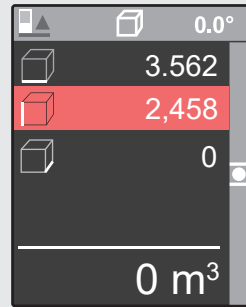
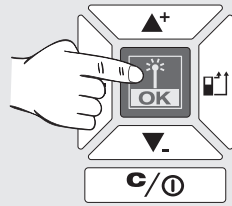

1



2

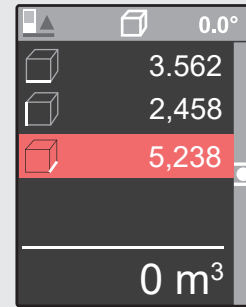
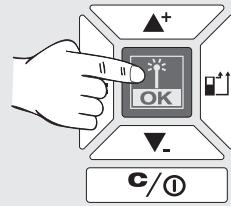

3

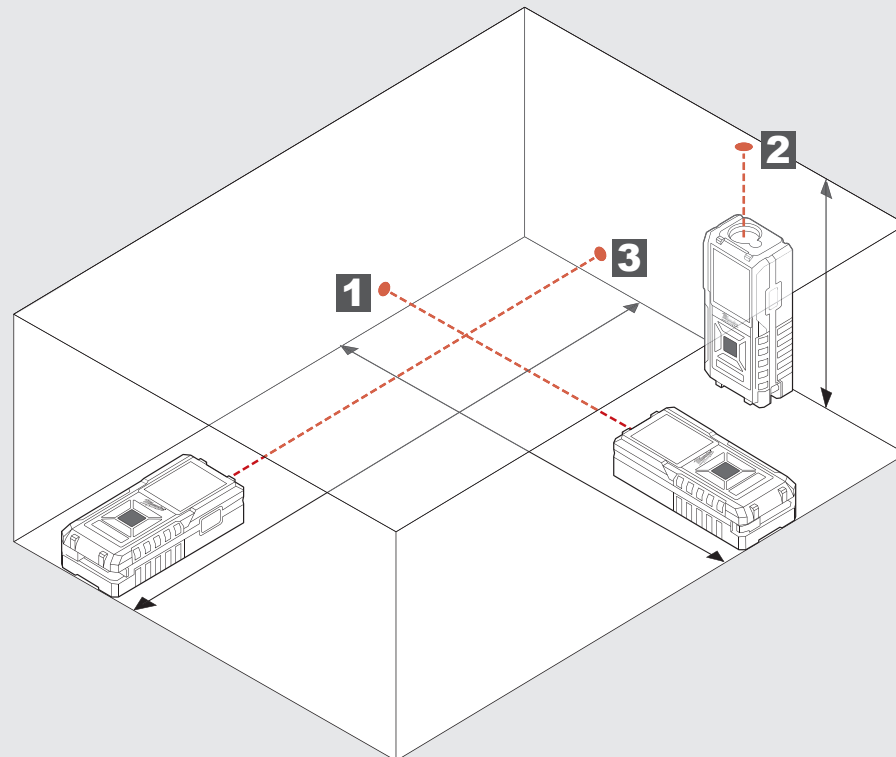
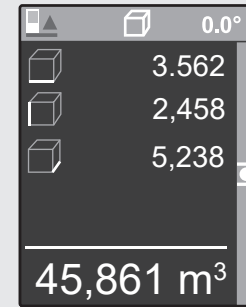
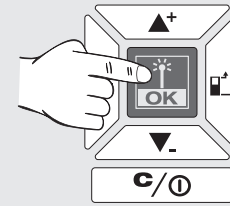

MISURAZIONE INDIRECTA ALTEZZA/LUNGHEZZA (SOLO CON L'LDM 100)

0

1

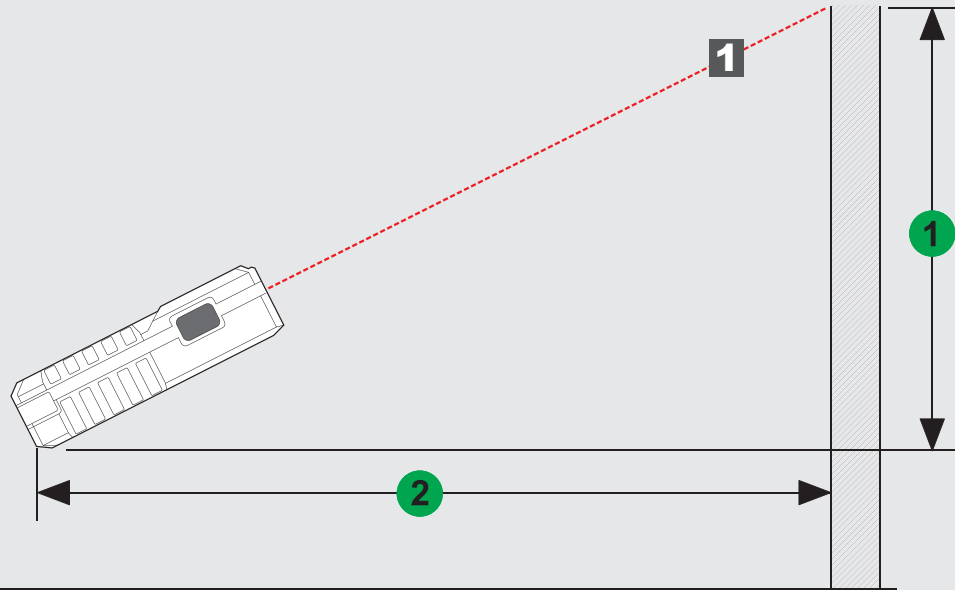
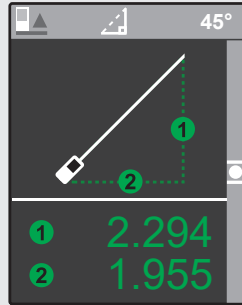
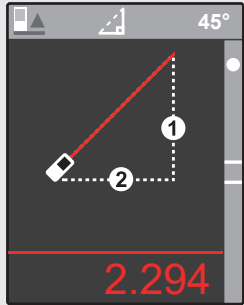
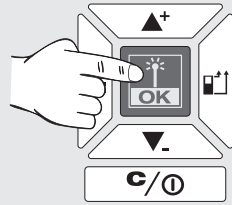

MISURAZIONE INDIRECTA ALTEZZA (SOLO CON L'LDM 100)

0

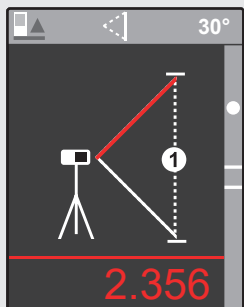

1

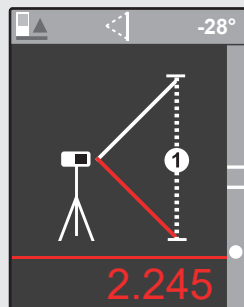
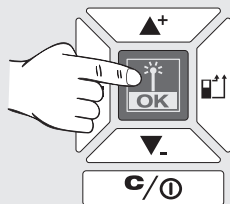

2

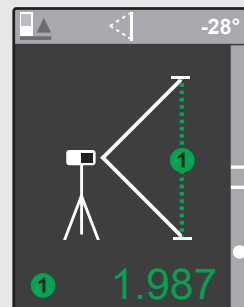
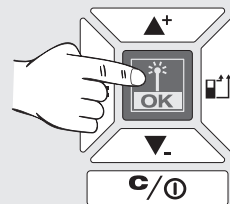

Usare un cavalletto o un'altra superficie stabile per misurare due diverse lunghezze.

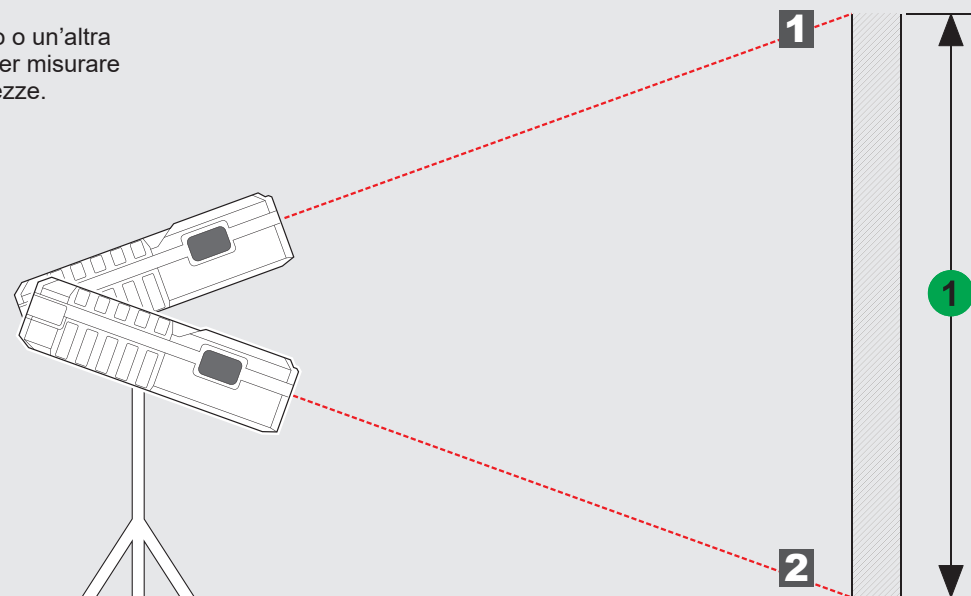

CONTENIDO

Instrucciones de seguridad importantes.....	1
Datos técnicos.....	2
Aplicación de acuerdo a la finalidad.....	2
Tabla de códigos de error.....	2
Resumen.....	3
Punto de medición.....	4
Menú.....	5
Iniciar.....	6
Medir la longitud.....	7
Medir la superficie.....	8
Medir la superficie total.....	9
Medir el volumen.....	10
Alturas indirectas / Nedición longitudinal (solo con LDM 100).....	11
Medición de alturas indirectas (solo con LDM 100).....	12

INSTRUCCIONES DE SEGURIDAD IMPORTANTES



Lea detenidamente las Instrucciones de seguridad y el Manual de empleo que se encuentran en el CD adjunto antes de empezar a trabajar con el producto.

Clasificación de láser

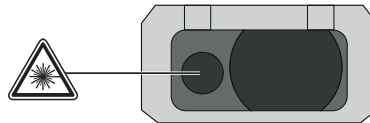

ADVERTENCIA:

El producto corresponde a la Clase de láser 2 según la norma EN60825-1:2014



Advertencia:

Evite el contacto directo con los ojos. Debido a la intensa brillantez del rayo láser se puede producir un deslumbramiento durante un breve período de tiempo.

Absténgase de mirar directamente al rayo láser y no dirija éste a otras personas.

No deslumbrar intencionadamente a terceros.

Advertencia:

No hacer funcionar el aparato láser cerca de niños o permitir a los niños que utilicen el aparato láser.

¡Atención! Una superficie reflectante podría dirigir el rayo láser de vuelta hacia el operador o hacia otra persona.

Respetar una distancia de seguridad de las partes móviles.

Realizar periódicamente mediciones de control. Especialmente cuando el producto ha estado sometido a esfuerzos excesivos así como antes y después de tareas de medición importantes.

Pueden producirse medidas erróneas si se utiliza un producto que esté defectuoso, después de haberse caído o haber sido objeto de transformaciones no permitidas.

Advertencia: El empleo de elementos de control, ajustes u operaciones diferentes a las especificadas en el manual podrían derivar en la exposición a una radiación peligrosa.

El aparato de medición por láser tiene un campo de aplicación limitado. (Véase capítulo Datos técnicos). Los intentos de medir fuera del rango máximo y mínimo ocasionan inexactitudes. El uso en condiciones meteorológicas adversas como por ejemplo demasiado calor, demasiado frío, luz solar brillante, lluvia, nieve, niebla u otras condiciones que limitan la visión, pueden producir mediciones inexactas.

Si el aparato de medición por láser se lleva de un ambiente cálido a un ambiente frío (o al revés), espere hasta que el aparato se haya adaptado a la nueva temperatura ambiente

Guardar el aparato de medición por láser siempre en el interior de locales, proteger el aparato contra sacudidas y vibraciones o temperaturas extremas

Proteger el aparato de medición por láser siempre contra polvo, humedad y alta humedad del aire. Esto puede destruir los componentes internos o influir en la exactitud.

No utilice detergentes o disolventes agresivos. Limpiar solamente con un paño limpio y blando.

Evite golpes fuertes sobre el aparato de medición por láser o la caída del mismo. Se debería comprobar la exactitud del aparato, si éste se ha caído o si ha estado expuesto a otras cargas mecánicas.

Las reparaciones necesarias en este aparato láser deben ser realizadas únicamente por personal especializado y autorizado.

No utilizar el producto en áreas con una atmósfera potencialmente explosiva o volátil.



Las pilas vacías no deben eliminarse con la basura doméstica. Cuide el medio ambiente y llévelas a los puntos de recogida disponibles de conformidad con las regulaciones nacionales y locales. No desechar el producto con la basura doméstica.

Desechar el producto correctamente. Cumplir con las normas de desecho específicas del país. Respetar la normativa específica nacional y local. Póngase en contacto con la autoridad local competente o con la tienda en la que adquirió el producto para obtener información acerca de la eliminación correcta.



Marca CE

DATOS TÉCNICOS

	LDM 45	LDM 100
Sistema óptico	15 mm x 9 mm	18 mm
Rango de medición		
Distancia mínima	45 m (Tolerancia: 45,1 m)	100 m (Tolerancia: 101 m)
Distancia máxima	0,05 m	0,05 m
Medición de distancia		
Tolerancia típica (válida para una reflectividad del objetivo del 100 % (pared pintada en blanco), baja iluminación de fondo, 25 °C)	± 2,0 mm (se debe tener en cuenta una tolerancia adicional de 0,1 mm/m)	± 2,0 mm (se debe tener en cuenta una tolerancia adicional de 0,1 mm/m)
Tolerancia máxima (válida para objetivos con menor reflectividad, un mayor nivel de iluminación de fondo o de temperaturas que se aproxime al valor inferior o superior)	± 4,0 mm (se debe tener en cuenta una tolerancia adicional de 0,15 mm/m)	± 4,0 mm (se debe tener en cuenta una tolerancia adicional de 0,15 mm/m)
Unidad más pequeña indicada	1,0 mm	1,0 mm
Tamaño del punto láser		
Distancia de 16 m:	25 x 50 mm	25 x 50 mm
Clase de láser	2	2
Tipo de láser	635 nm, < 1 mW	635 nm, < 1 mW
Ángulo vertical		
Ángulo vertical	+1 grado	+1 grado
Ángulo horizontal	±1 grado	±1 grado
Tipo de display	LCD (31,5 mm x 40 mm)	LCD (31,5 mm x 40 mm)
Desconexión automática del láser	90 segundos	90 segundos
Desconexión automática del aparato	180 segundos	180 segundos
Alimentación de corriente	AAA 2x (batería alcalina)	AAA 2x (batería alcalina)
Vida útil de la batería	8000 (medición individual)	8000 (medición individual)
Rango de temperatura de trabajo	-0°C a +40°C	-0°C a +40°C
Rango de temperatura de almacenamiento	-10°C a +60°C	-10°C a +60°C
Peso sin batería	87 g	122 g
Clase de protección	IP54 (protegido contra el polvo y las salpicaduras de agua)	IP54 (protegido contra el polvo y las salpicaduras de agua)

APLICACIÓN DE ACUERDO A LA FINALIDAD

El aparato de medición por láser es apropiado para la medición de distancias e inclinaciones. No utilice este producto para ninguna otra aplicación que no sea su uso normal.

TABLA DE CÓDIGOS DE ERROR

Código	Descripción	Solución
Err500	Problemas de hardware	Apague el medidor y vuelva a encenderlo. Si el problema persiste, lleve el medidor de láser al centro de servicio técnico más próximo.

RESUMEN

BARRA DE ESTADO

- ▶ Punto de medición de referencia, tipo de medición, ángulo de medición (solo con LDM 100), plano de medición (solo con LDM 100)

MONITOR

- ▶ Menú
- ▶ Mediciones
- ▶ Ajustes

HACIA ARRIBA / SUMAR

- ▶ Desplazarse en el menú hacia arriba
- ▶ Sumar el valor

MEDICIÓN / OK

- ▶ Encender el láser
- ▶ Guardar el valor medido
- ▶ Seleccionar OK en el menú

MENÚ

- ▶ Proceso
- ▶ Medición
- ▶ Ajustes

HACIA ABAJO / RESTAR

- ▶ Desplazarse en el menú hacia abajo
- ▶ Restar el valor

BORRAR / ENCENDER / APAGAR

- ▶ ENCENDIDO / APAGADO (mantener pulsada la tecla hasta que el dispositivo emita una señal acústica)
- ▶ Borrar el valor medido

PUNTO DE MEDICIÓN

- ▶ Atrás (ajuste estándar)
- ▶ Adelante
- ▶ Ángulo (se activa automáticamente al extender el perno)



MEDIR

- ▶ Encender el láser
- ▶ Guardar el valor medido

CAMBIAR LAS BATERÍAS

- ▶ Si parpadea el símbolo de batería, cambiar las baterías.

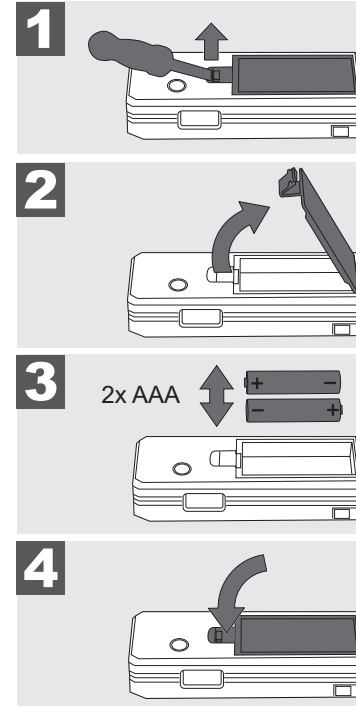

TRÍPODE

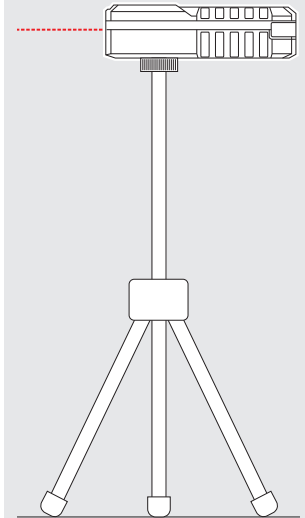

PERNO ANGULAR

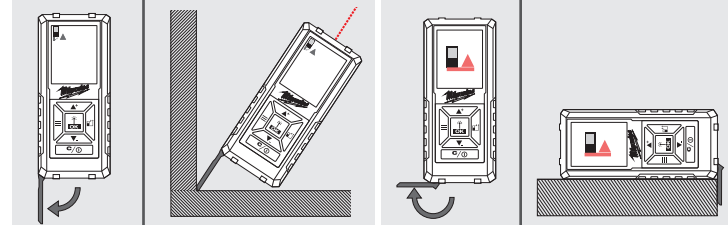

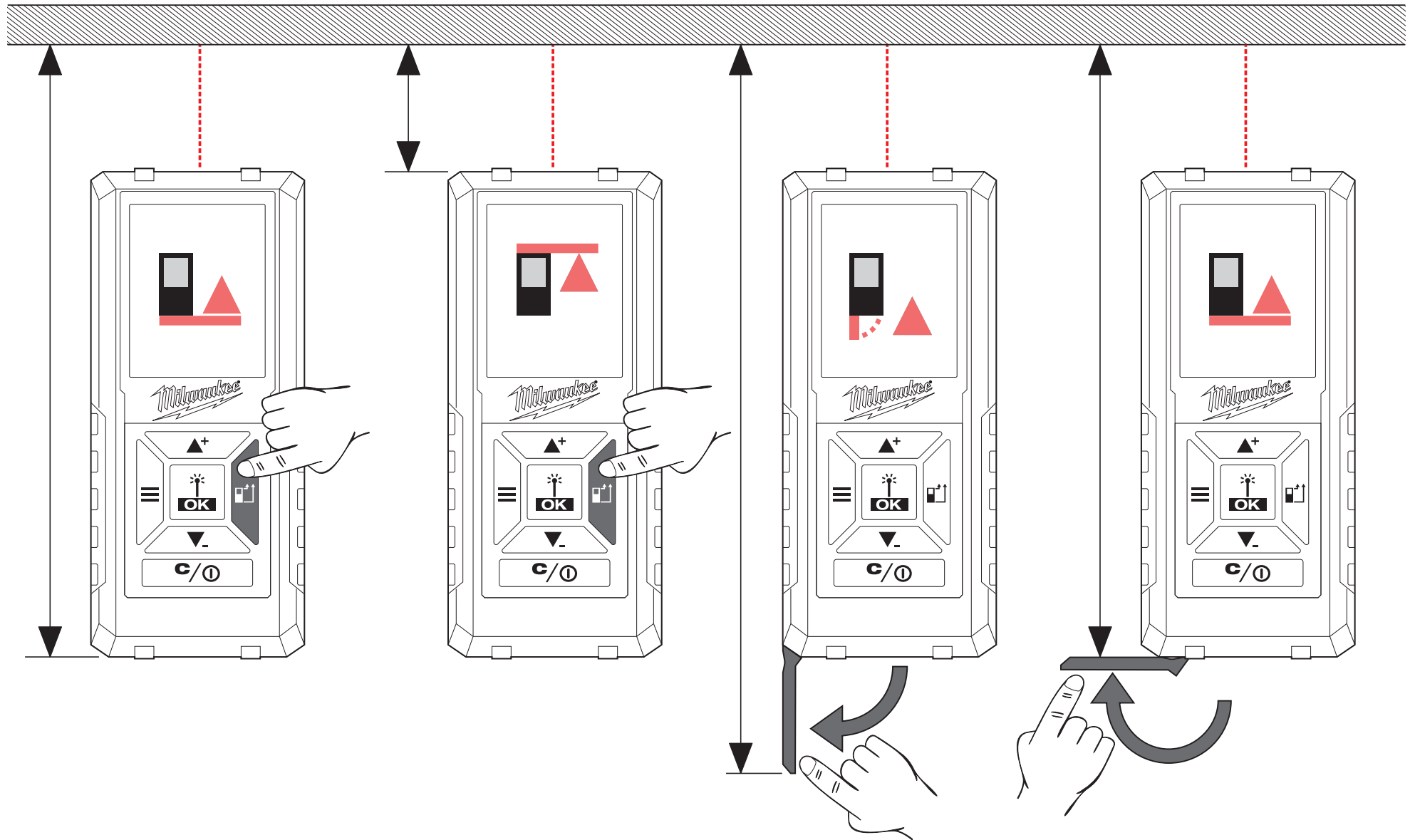

MENÚ

PROCESO

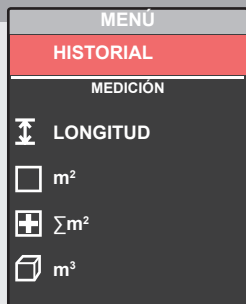

Visualización de las últimas 30 mediciones/cálculos.

Las mediciones individuales para calcular la superficie, la superficie total, el volumen, etc., no se guardan en PROCESO, sino que solo se guarda el resultado de los cálculos.

Para borrar una entrada de datos, pulse la tecla C/ENCENDIDO/APAGADO.

De los valores guardados en PROCESO se pueden sumar o restar mediciones o cálculos. Solo se pueden llevar a cabo cálculos del mismo tipo (longitud, superficie, volumen, etc.).

Realización de un cálculo:

1. Utilizar las teclas ▲+ ▼- para seleccionar un modo de medición del PROCESO.
2. Pulsar la tecla OK.
3. Realizar las mediciones necesarias para el cálculo.
4. Pulsar la tecla OK para guardar el nuevo cálculo en el PROCESO.

MEDICIÓN

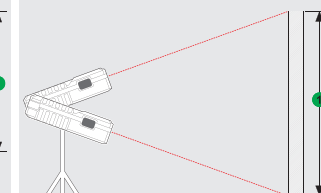
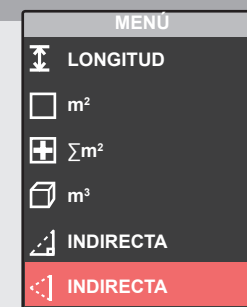
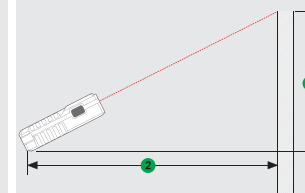
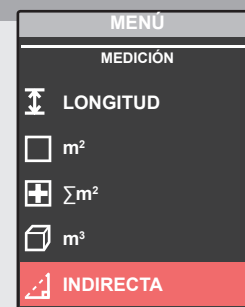
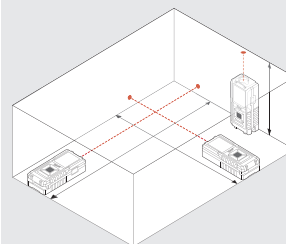
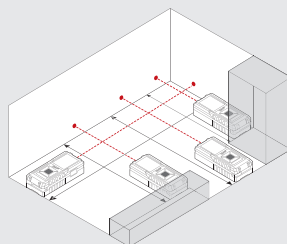
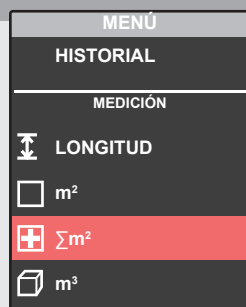
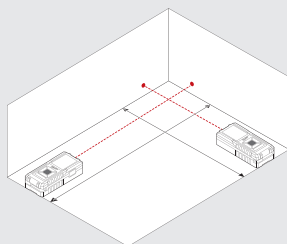
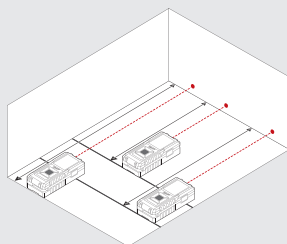
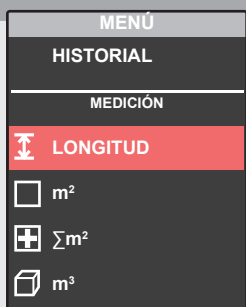

AJUSTES



Elegir la unidad de medida deseada.



Señal acústica activada/desactivada.



Elegir idioma.

INICIAR

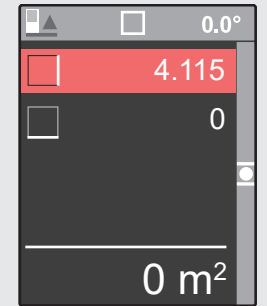
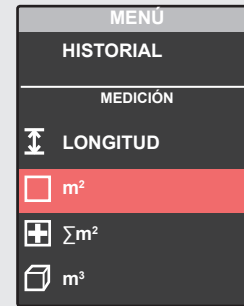
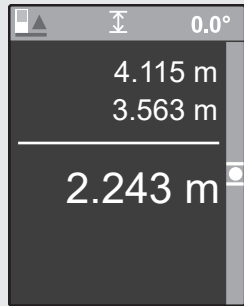
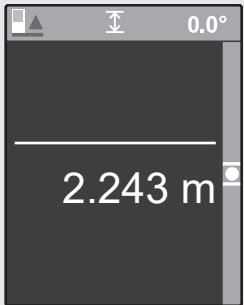
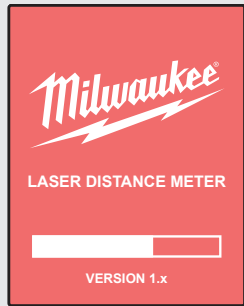
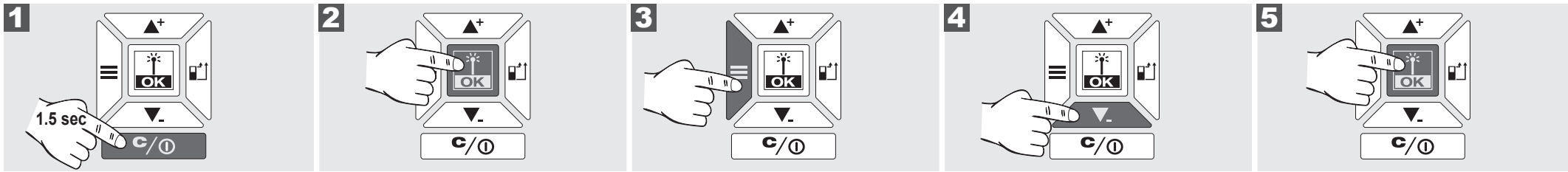

Al encender se activa automáticamente el MODO DE MEDICIÓN LONGITUDINAL.

Realice una MEDICIÓN LONGITUDINAL, o bien....

... pulse la tecla de menú para cambiar al menú ...

... y elija otro modo operativo sirviéndose de las teclas ▲⁺ ▼₋ y ...

... y active dicho modo operativo pulsando la tecla OK.

MEDIR LA LONGITUD

0

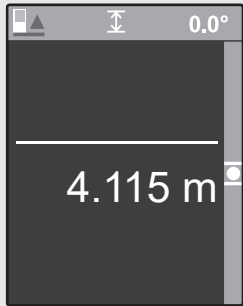

Valor medido en blanco = se ha medido el valor

1

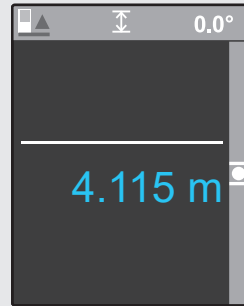
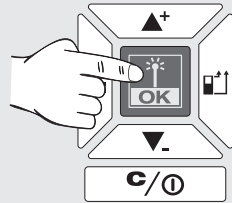

Valor medido en azul = se ha guardado el valor temporalmente

2

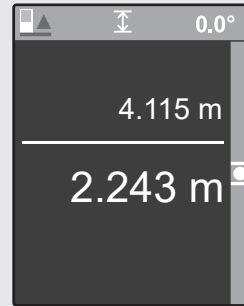
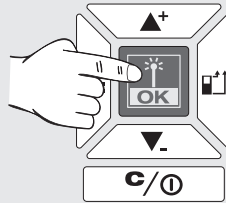

3

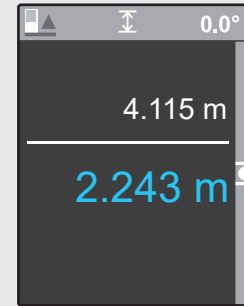
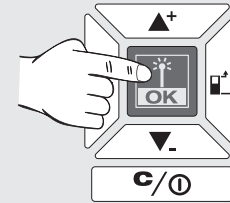

4

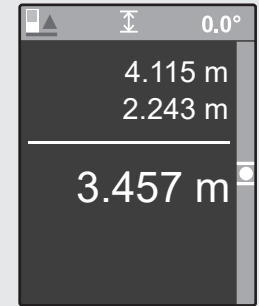
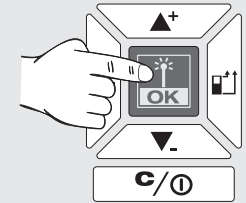

5

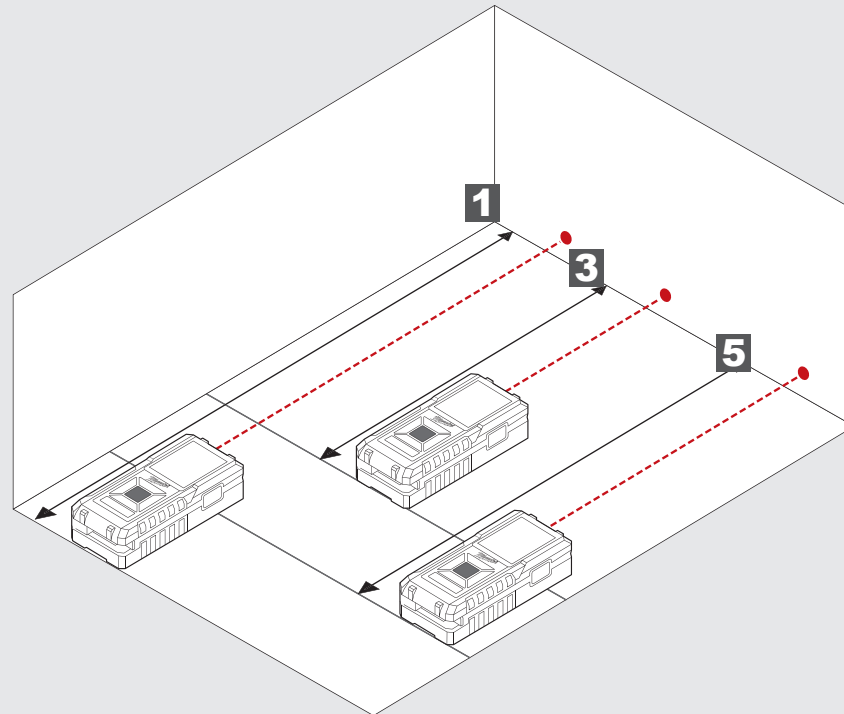
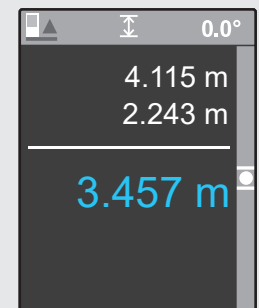
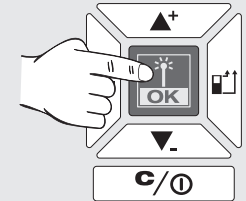

MEDIR LA SUPERFICIE

0

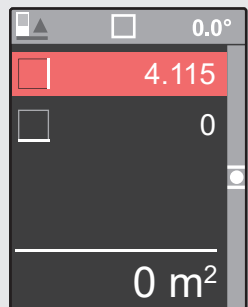

1

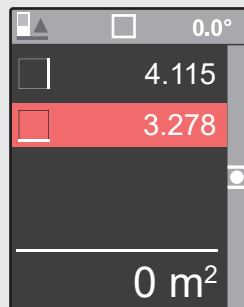
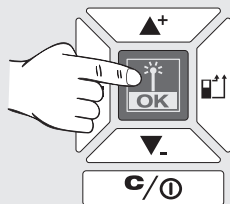

2

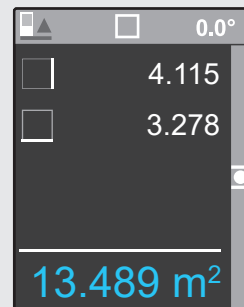
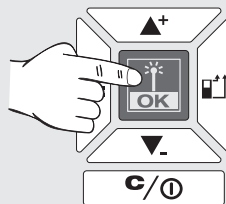

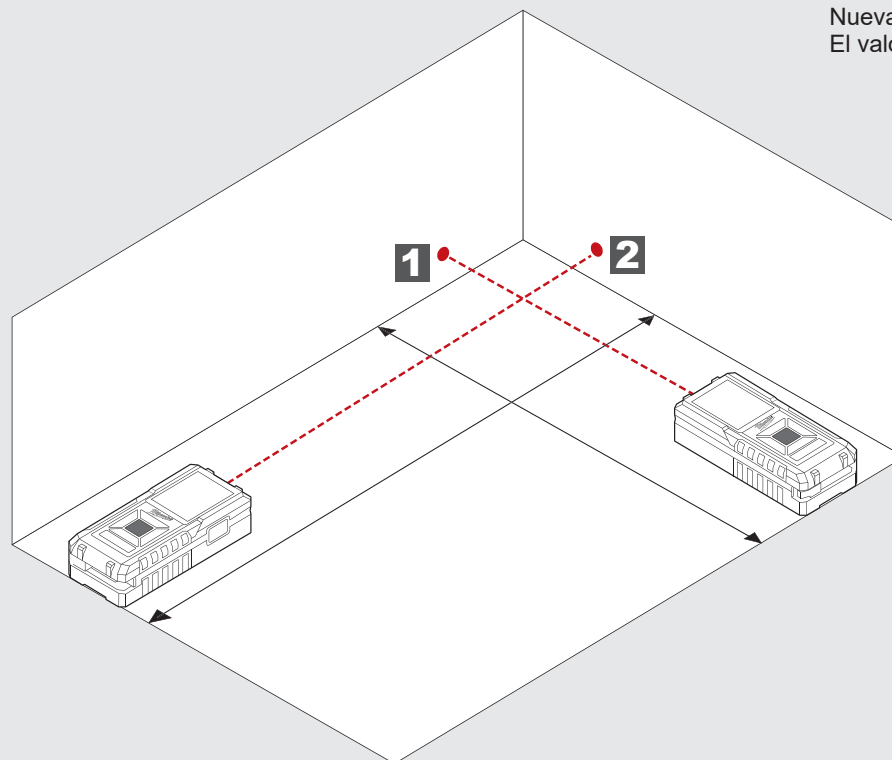
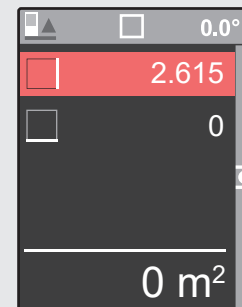
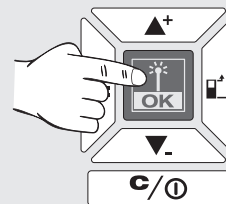

2

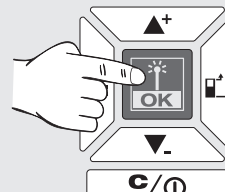
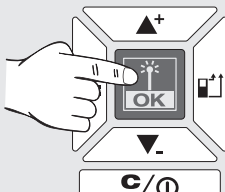
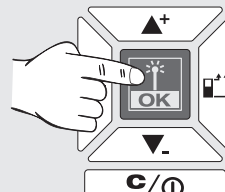
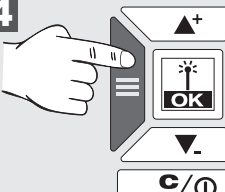

Nueva medición.
El valor se guarda en PROCESO.

MEDIR LA SUPERFICIE TOTAL

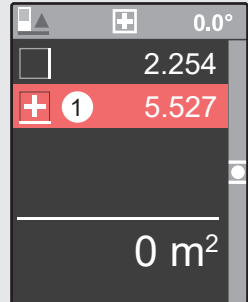
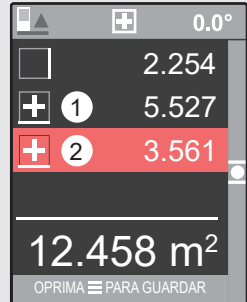
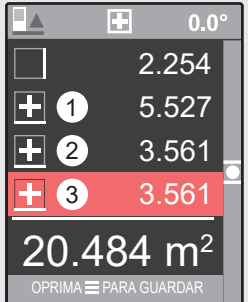
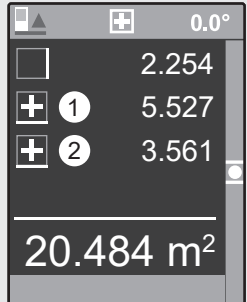
0	1 	2 	3 	4 
				

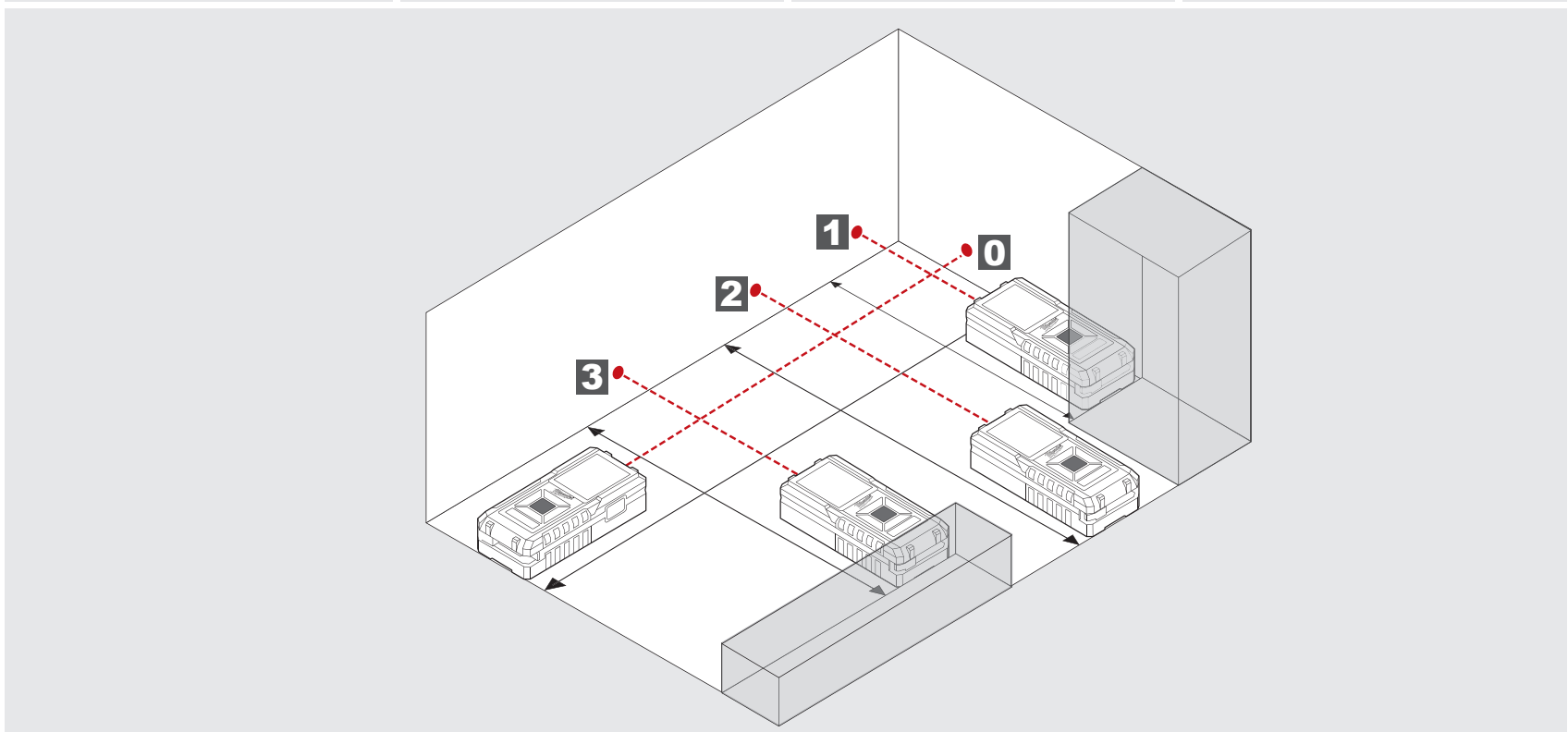

4





Nueva medición.
El resultado se guarda en PROCESO.

MEDIR EL VOLUMEN

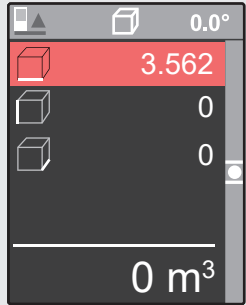
0

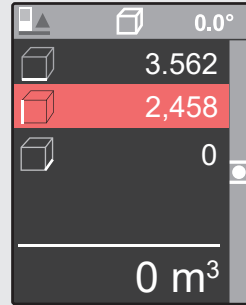
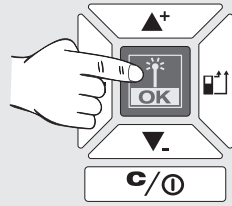

1



2

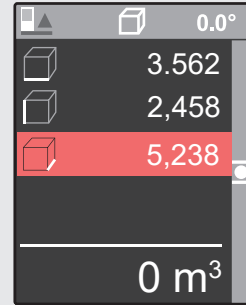
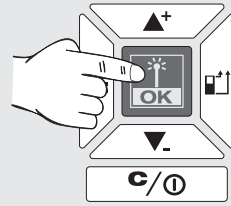

3

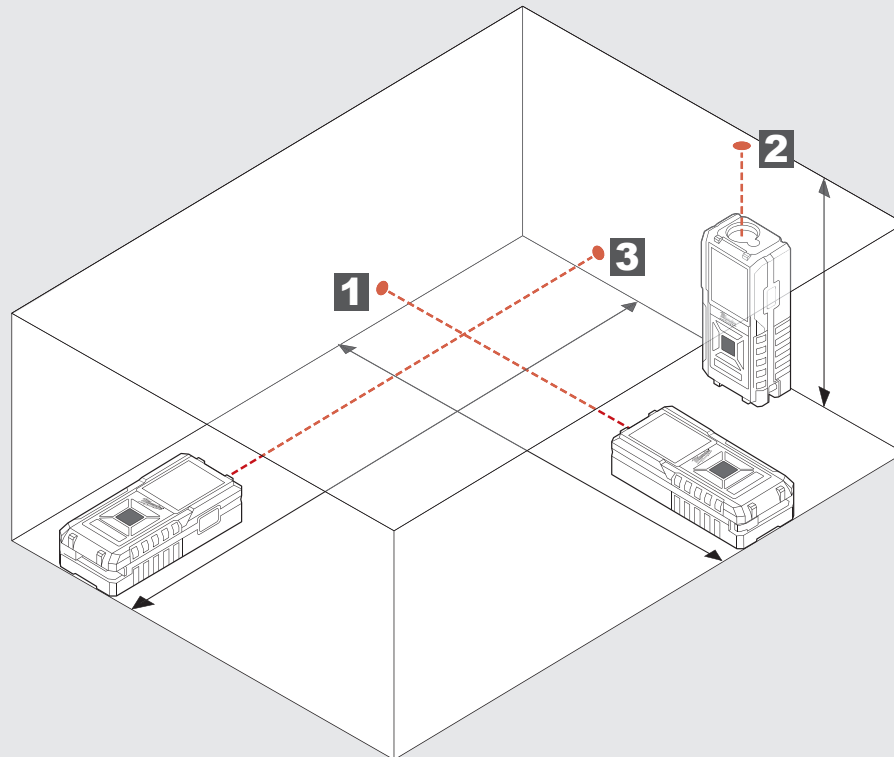
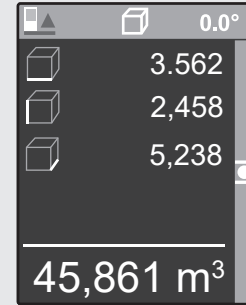
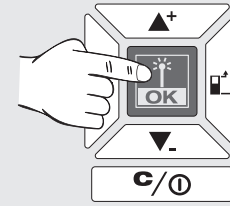

ALTURAS INDIRECTAS / MEDICIÓN LONGITUDINAL (SOLO CON LDM 100)

0

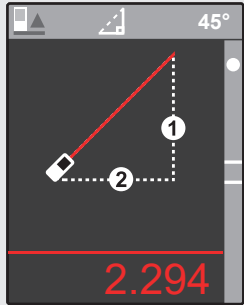

1

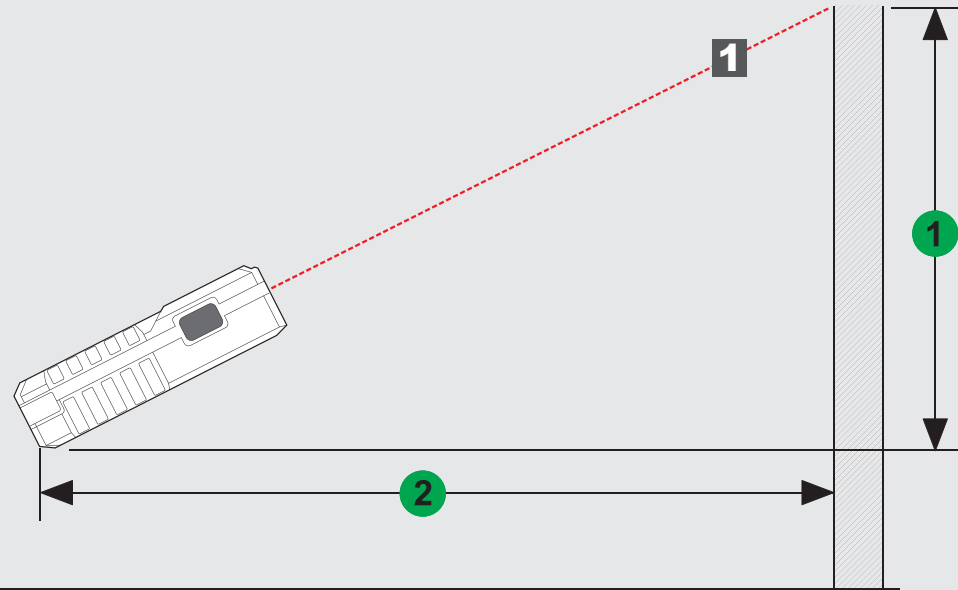
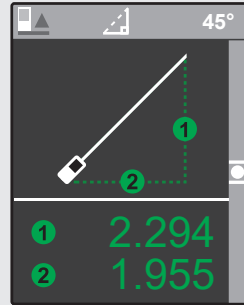
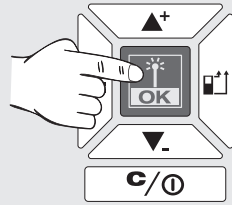

MEDICIÓN DE ALTURAS INDIRECTAS (SOLO CON LDM 100)

0

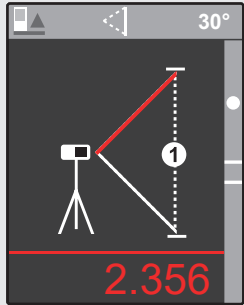

1

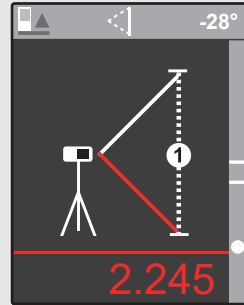
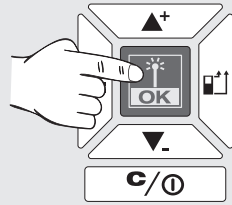

2

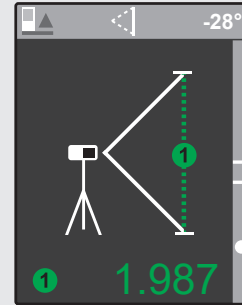
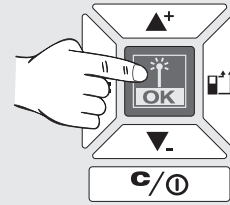

Para medir dos longitudes diferentes, utilice un trípode o alguna otra superficie estable.

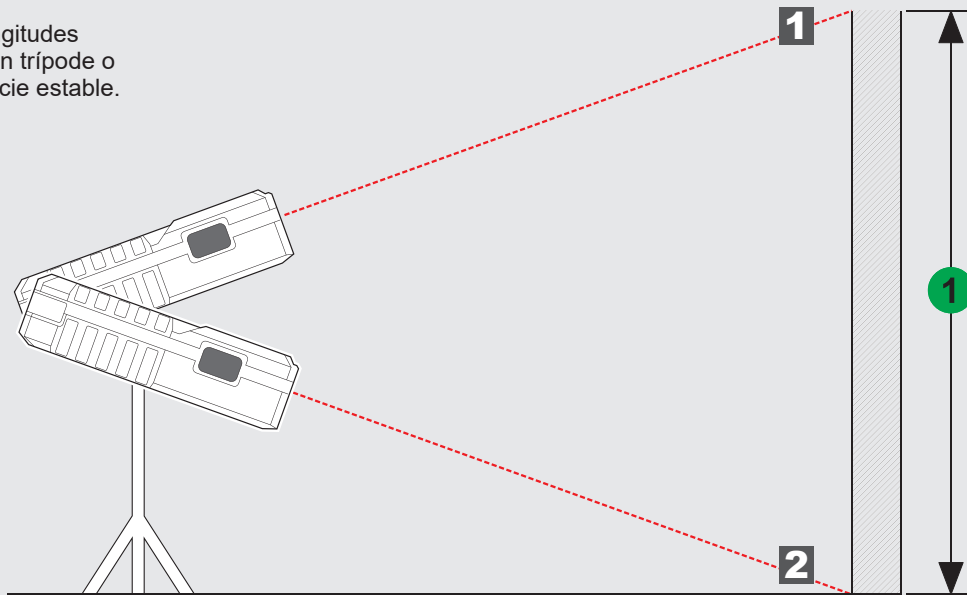

CONTEÚDO

Instruções de Segurança Importantes.....	1
Características técnicas	2
Utilização autorizada	2
Tabela de códigos de erro	2
Vista geral.....	3
Ponto de medição.....	4
Menu.....	5
Iniciar	6
Medir o comprimento.....	7
Medir a área	8
Medir a área total.....	9
Medir o volume	10
Medição de altura/comprimento indireta (só com LDM 100).....	11
Medição de altura indireta (só com LDM 100).....	12

INSTRUÇÕES DE SEGURANÇA IMPORTANTES



Não utilizar o produto, antes de ler atentamente as Instruções de Segurança e o Manual de Operação incluídos no CD-ROM fornecido com o produto.

Classificação do laser

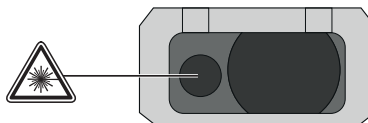

ATENÇÃO:

Produto laser de Classe 2, de acordo com a Norma EN60825-1:2014



Aviso:

Não olhar directamente para o feixe de luz laser. O raio laser pode queimar os olhos e levar a uma cegueira temporária.

Não olhar directamente para o feixe de luz laser, nem apontar o feixe de luz directamente para as outras pessoas.

Não apontar o feixe de luz laser para outras pessoas.

Aviso:

Não opere o aparelho de laser na proximidade de crianças e não deixe crianças usar o aparelho de laser.

Atenção! Uma superfície reflectora pode reflectar o raio laser ao operador ou a terceiros.

Manter as extremidades a uma distância segura das peças móveis.

Efectuar medições de teste frequentes. Especialmente, antes, durante ou depois de medições importantes.

Em caso de anomalia no funcionamento, queda ou utilização incorrecta do produto, ou se este tiver sido modificado, existe o risco de as medições efectuadas serem incorrectas.

Aviso: A utilização de elementos de controlo, ajustes ou a execução de processos não determinados no manual pode levar a uma exposição à radiação perigosa.

O medidor a laser tem uma área de utilização limitada. (Veja a secção Dados técnicos). Tentativas de medir fora da área máxima e mínima levam medições inexactas. A utilização em caso de condições adversas, como muito quente, muito frio, luz do sol muito clara, chuva, neve, névoa ou outras condições que prejudiquem a vista pode levar a medições inexactas.

Se o medidor a laser for levado de um ambiente quente a um ambiente frio (ou vice-versa), aguarde até o aparelho se adaptar à temperatura ambiente nova.

Guarde o medidor a laser no interior, proteja o aparelho contra choque, vibrações ou temperaturas extremas.

Proteja o medidor a laser contra pó, humidade e alta humidade do ar. Isto poderia destruir componentes internos ou influenciar a precisão.

Não use detergentes ou solventes agressivos. Só limpe com um pano limpo e macio.

Evite choques duros ou a queda do medidor a laser. A precisão do aparelho deve ser verificada depois dele cair ou ter sido exposto a outros esforços mecânicos.

Reparações necessárias neste aparelho de laser só devem ser executadas pelo pessoal especializado e autorizado.

Não utilizar o produto em áreas com risco de explosão ou ambientes agressivos.

 As pilhas esgotadas não devem ser descartadas juntamente com os resíduos domésticos. Proteger o ambiente e descartar as pilhas nos pontos de recolha (Pilhões) da sua área de residência. O instrumento não deve ser descartado juntamente com os resíduos domésticos. Eliminar o instrumento de acordo com os regulamentos aplicáveis em vigor. Respeitar os regulamentos nacionais específicos do país. Contacte a sua autoridade local ou o seu vendedor para informações relativas à eliminação.

 Marca CE

CARACTERÍSTICAS TÉCNICAS

	LDM 45	LDM 100
Lente	15 mm x 9 mm	18 mm
Gama de medição		
Distância mínima	45 m (Tolerância: 45,1 m)	100 m (Tolerância: 101 m)
Distância máxima	0,05 m	0,05 m
Medição de distância		
Tolerância típica (aplica-se à reflexão do alvo 100 % (parede pintada em branco), baixa iluminação do fundo, 25 °C)	± 2,0 mm (uma tolerância suplementar de 0,1 mm/m deve ser considerada)	± 2,0 mm (uma tolerância suplementar de 0,1 mm/m deve ser considerada)
Tolerância máxima (aplica-se a alvos com pequena reflexão, alta iluminação de fundo ou temperaturas que se aproximam ao valor inferior/superior)	± 4,0 mm (uma tolerância suplementar de 0,15 mm/m deve ser considerada)	± 4,0 mm (uma tolerância suplementar de 0,15 mm/m deve ser considerada)
Menor unidade indicada	1,0 mm	1,0 mm
Tamanho do ponto de laser		
Distância de 16 m:	25 x 50 mm	25 x 50 mm
Classe de laser	2r	2r
Tipo de laser	635 nm, < 1 mW	635 nm, < 1 mW
Raio laser		
ângulo vertical	+1 grau	+1 grau
ângulo horizontal	±1 grau	±1 grau
Tela tipo	LCD (31,5 mm x 40 mm)	LCD (31,5 mm x 40 mm)
Desligamento automático do laser	90 segundos	90 segundos
Desligamento automático do aparelho	180 segundos	180 segundos
Alimentação eléctrica	AAA 2x (bateria alcalina)	AAA 2x (bateria alcalina)
Vida útil da bateria	8000 (medição individual)	8000 (medição individual)
Gama de temperatura de trabalho	-0°C a +40°C	-0°C a +40°C
Gama de temperatura de armazenamento	-10°C a +60°C	-10°C a +60°C
Peso sem bateria	87 g	122 g
Classe de protecção	IP54 (protegido contra pó e salpicos de água)	IP54 (protegido contra pó e salpicos de água)

UTILIZAÇÃO AUTORIZADA

O medidor a laser destina-se a medir distâncias e inclinações.

Não use este produto de outra maneira sem ser a normal para o qual foi concebido.

TABELA DE CÓDIGOS DE ERRO

Código	Descrição	Solução
Err500	Problemas de hardware	Desligue e ligue novamente o aparelho de medição. Se o problema perdurar, leve o aparelho de medição à central de assistência mais próxima.

VISTA GERAL

BARRA DE STATUS

- ▶ Ponto de medição de referência, tipo de medição, ângulo de medição (só com LDM 100), nível de medição (só com LDM 100)

TELA

- ▶ Menu
- ▶ Medições
- ▶ Configuração

PARA CIMA / ADICIONAR

- ▶ Ir para cima no menu
- ▶ Adicionar o valor

MEDIÇÃO / OK

- ▶ Ligar o laser
- ▶ Memorizar o valor de medição
- ▶ Selecionar OK no menu

MENU

- ▶ Histórico
- ▶ Medição
- ▶ Configuração

PARA BAIXO / SUBTRAIR

- ▶ Ir para baixo no menu
- ▶ Subtrair o valor

APAGAR / LIGAR / DESLIGAR

- ▶ LIGAR / DESLIGAR (mantenha a tecla pressionada até o aparelho emitir um sinal sonoro)
- ▶ Apagar o valor de medição

PONTO DE MEDIÇÃO

- ▶ Atrás (ajuste padrão)
- ▶ Na frente
- ▶ Canto (é ativado automaticamente, desdobrando o pino)

MEDIR

- ▶ Ligar o laser
- ▶ Memorizar o valor de medição

TROCAR AS BATERIAS

- ▶ Troque as baterias quando o símbolo da bateria piscar.

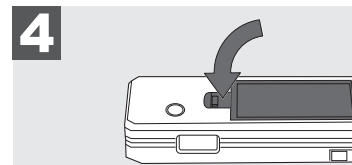
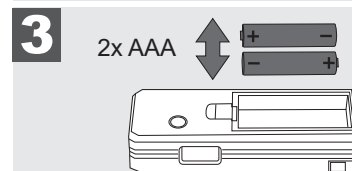
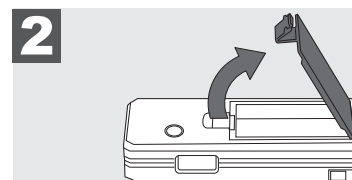
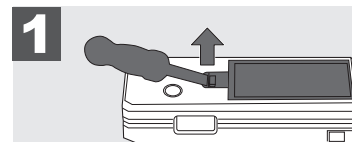

TRIPÉ

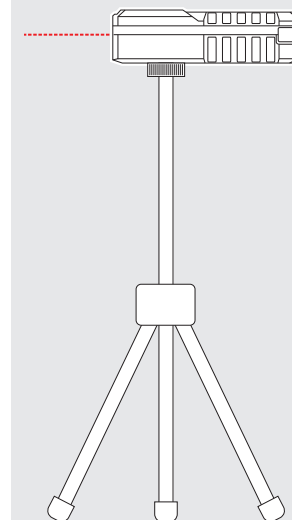

PINO DE CANTO

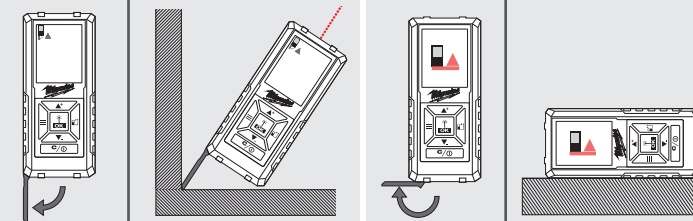

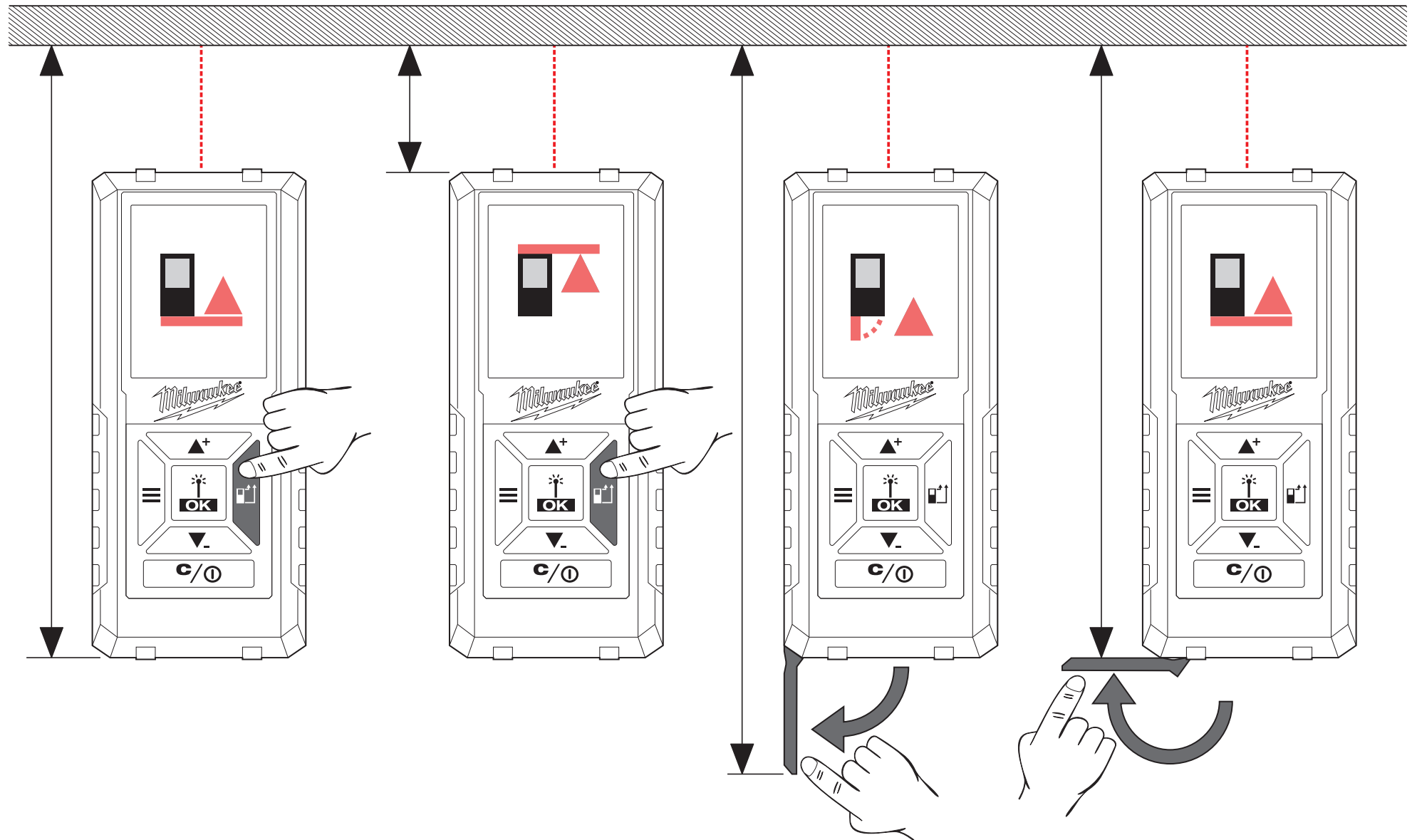

MENU

HISTÓRICO



Indicação das últimas 30 medições/cálculos.
As medições individuais para o cálculo da superfície, da área total, do volume, etc., não são memorizadas no HISTÓRICO. Só é memorizado o resultado dos cálculos.
Para apagar um registo, pressione a tecla C/ LIGAR/DESLIGAR.

Medições/cálculos podem ser adicionados ou subtraídos dos valores memorizados no HISTÓRICO. Só podem ser executados cálculos do mesmo tipo (comprimento, área, volume, etc.).

Execução de um cálculo:

1. Use as teclas ▲+ ▼- para selecionar um modo de medição do HISTÓRICO.
2. Pressione a tecla OK.
3. Faça as medições necessárias para o cálculo.
4. Pressione a tecla OK para memorizar o cálculo novo no HISTÓRICO.

MEDIÇÃO

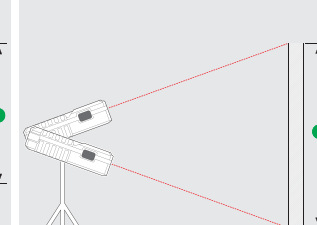
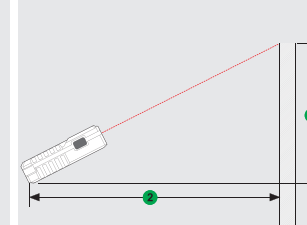
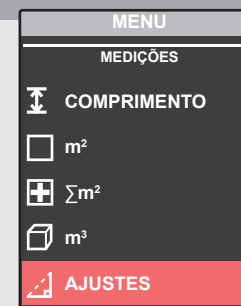
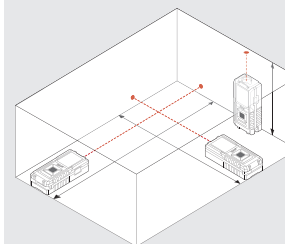
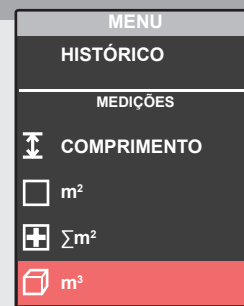
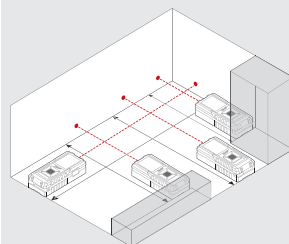
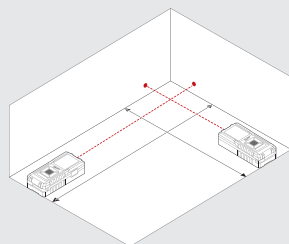
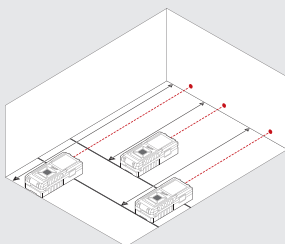

CONFIGURAÇÃO



Selecione a unidade de medição desejada.

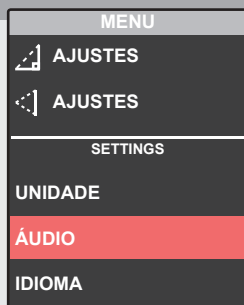

Ligar/Desligar o sinal sonoro.

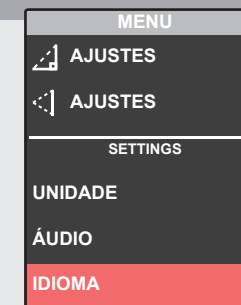

Selecione o idioma.

INICIAR

1

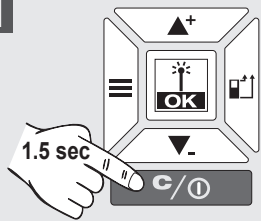

2

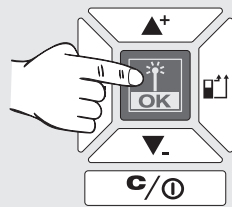

3

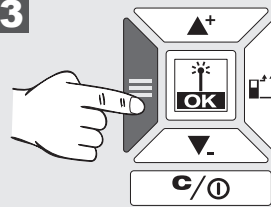

4

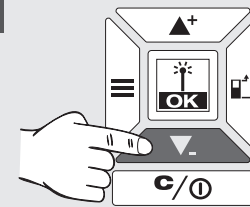

5

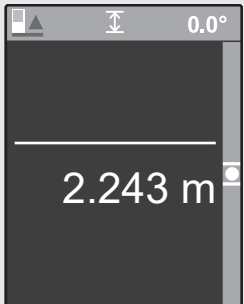
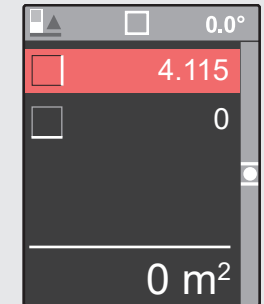
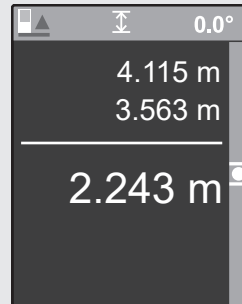
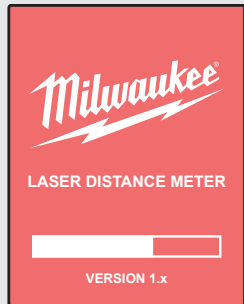
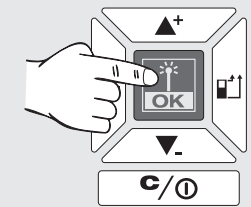

Depois de ligar, o MODO DE MEDIÇÃO DO COMPRIMENTO é ativado automaticamente.

Execute uma MEDIÇÃO DO COMPRIMENTO ou ...

... pressione a tecla do menu para ir ao menu ...

... e selecione outro modo de operação com as teclas ▲+ ▼- e ...

... e ative este modo de operação, pressionando a tecla OK.

MEDIR O COMPRIMENTO

0

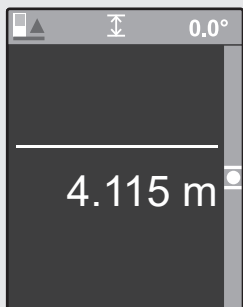

Valor de medição branco = Valor medido

1

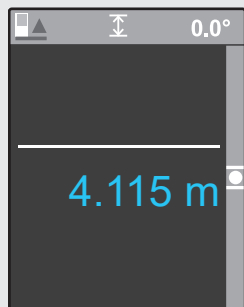
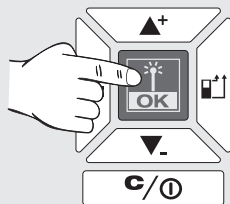

Valor de medição azul = Valor na memória intermediária

2

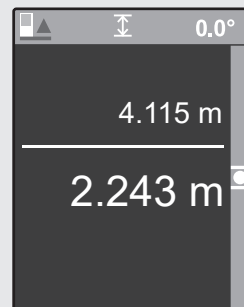
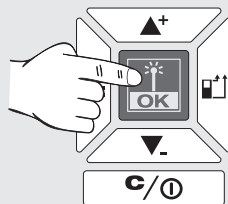

3

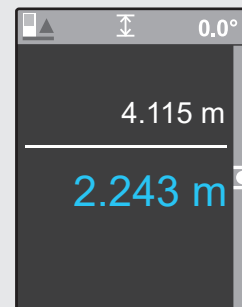
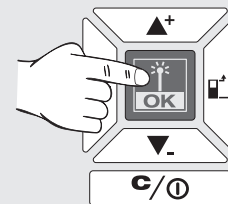

4

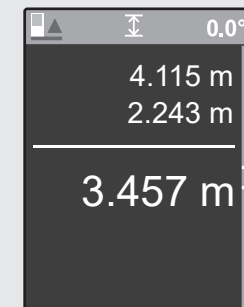
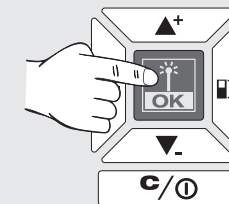

5

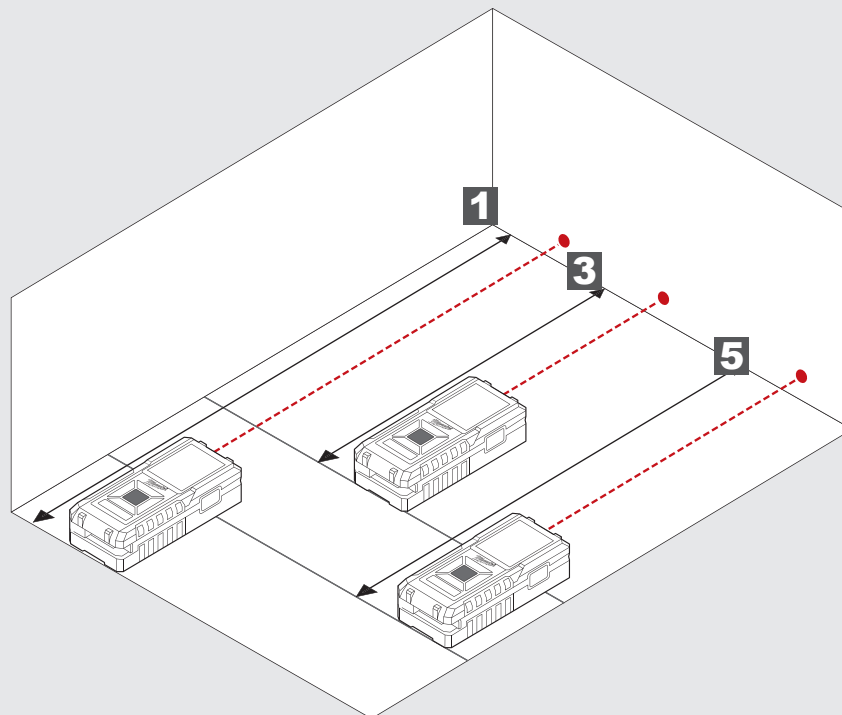
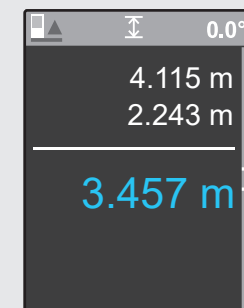
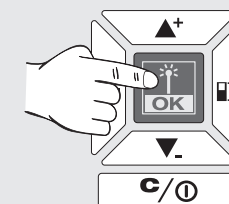

MEDIR A ÁREA

0

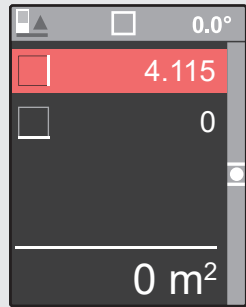

1

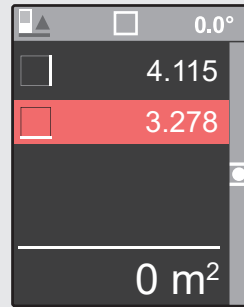
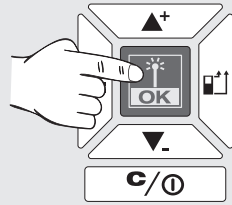

2

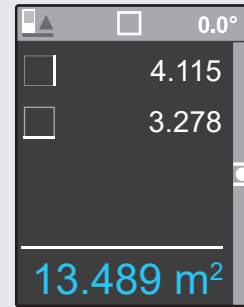
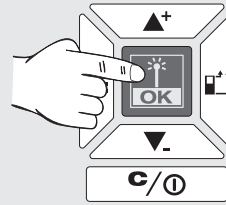

2

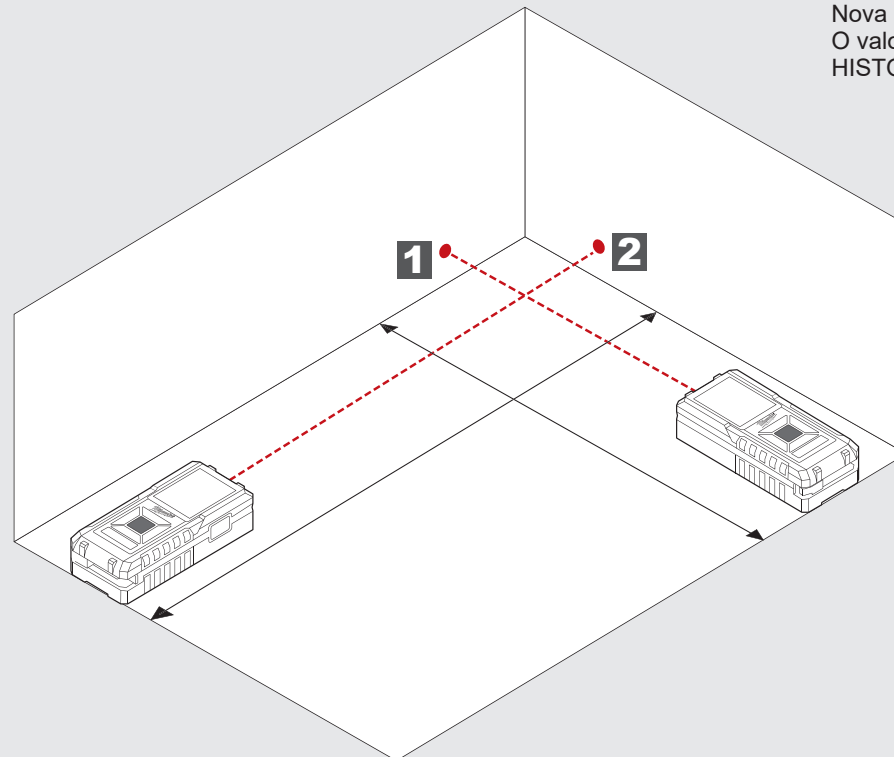
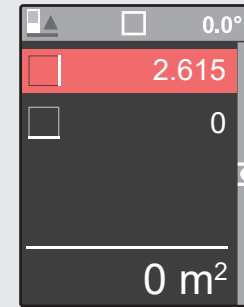
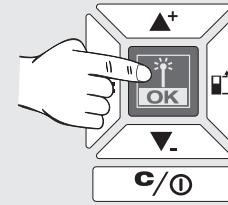

Nova medição.
O valor é memorizado no
HISTÓRICO.

MEDIR A ÁREA TOTAL

0

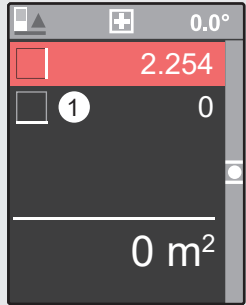

1

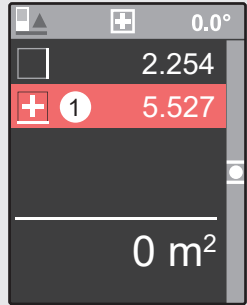
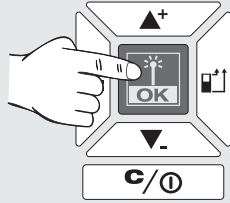

2

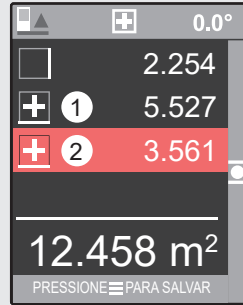
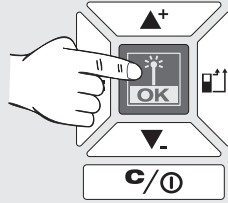

3

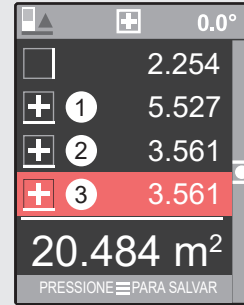
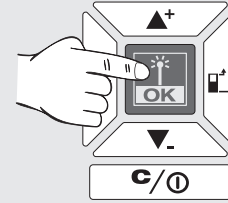

4

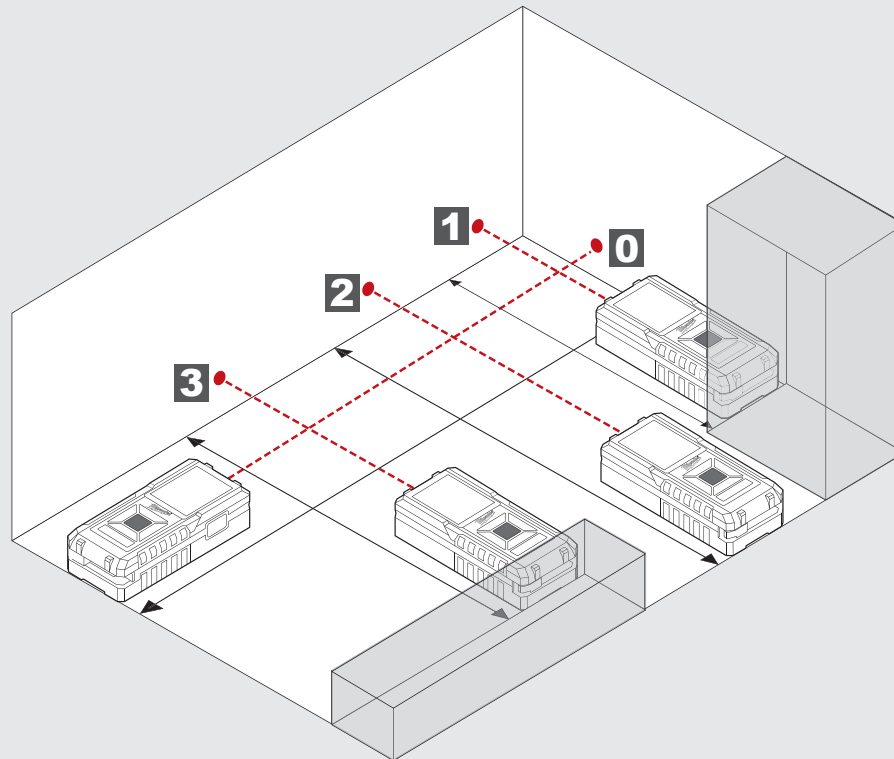
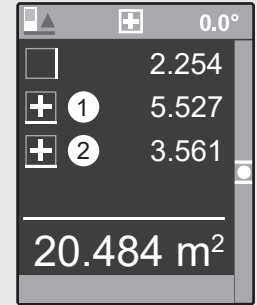
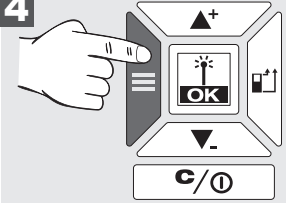

4

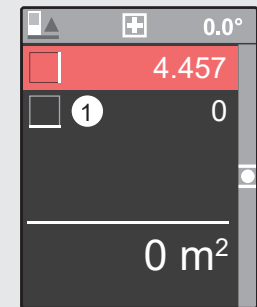
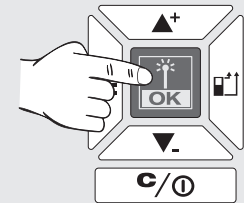

Nova medição.
O resultado é memorizado no HISTÓRICO.

MEDIR O VOLUME

0

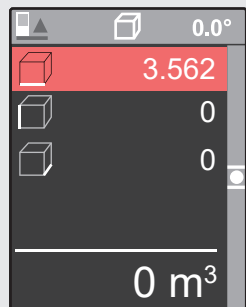

1

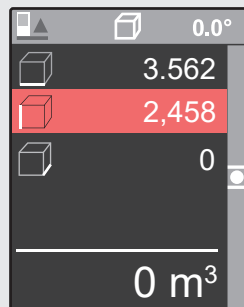
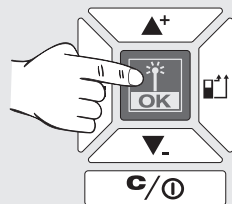

2

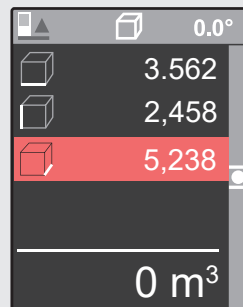
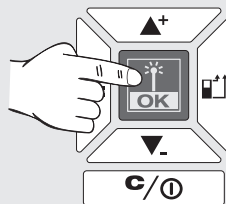

3

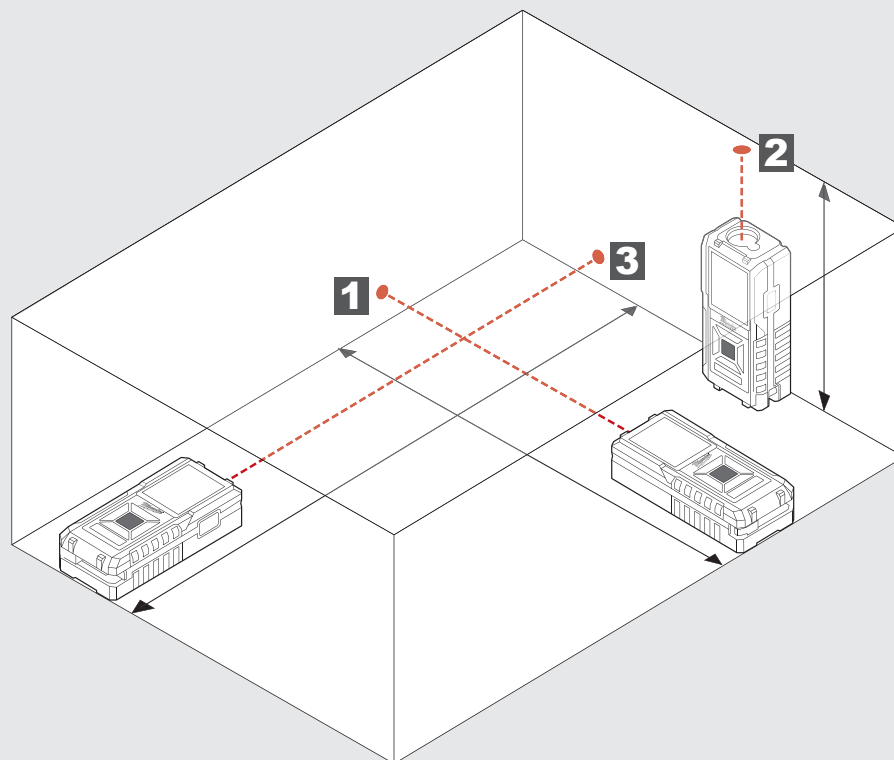
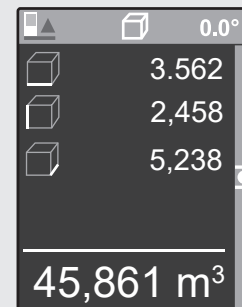
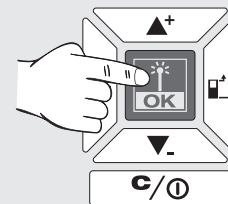

MEDIÇÃO DE ALTURA/COMPRIENTO INDIRETA (SÓ COM LDM 100)

0

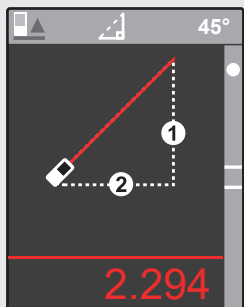

1

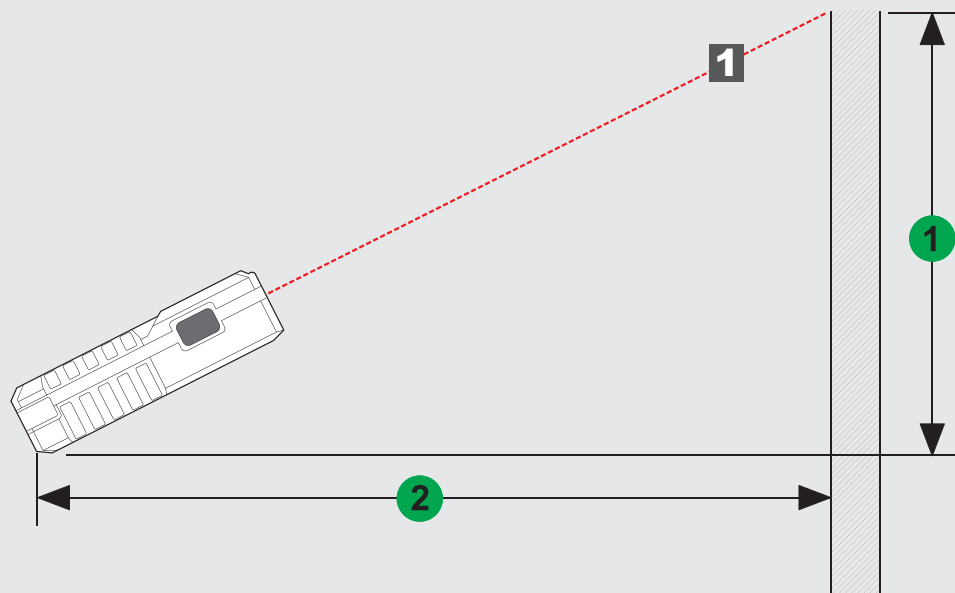
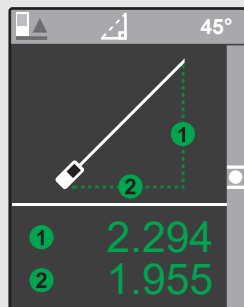
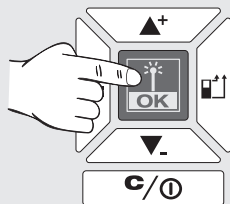

MEDIÇÃO DE ALTURA INDIRETA (SÓ COM LDM 100)

0

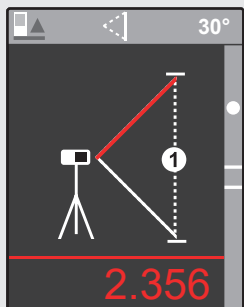

1

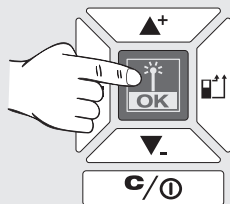

2

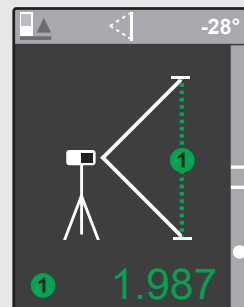
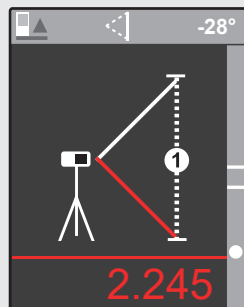
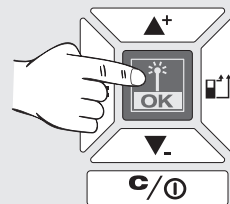

Use um tripé ou outra superfície sólida para medir dois comprimentos diferentes.

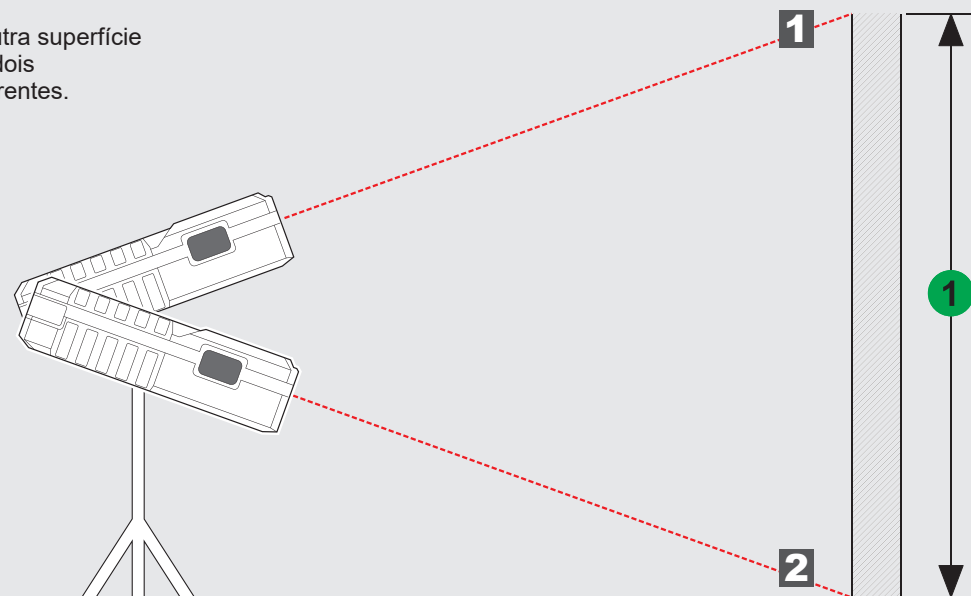

INHOUD

Belangrijke Veiligheidsvoorschriften	1
Technische gegevens	2
Voorgeschreven gebruik van het systeem	2
Tabel met storingscodes	2
Overzicht	3
Meetpunt	4
Menu	5
Starten	6
Lengte meten	7
Oppervlak meten	8
Totaal oppervlak meten	9
Volume meten	10
Indirecte hoogte-/lengtemeting (alleen met LDM 100)	11
Indirecte hoogtemeting (alleen met LDM 100)	12

BELANGRIJKE VEILIGHEIDSVOORSCHRIFTEN



Gebruik dit product niet voordat u de veiligheidsinstructies en de gebruiksaanwijzing op de bijgevoegde CD hebt bestudeerd.

Laserclassificatie

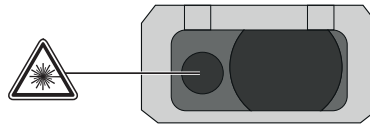

WAARSCHUWING:

Het is een Klasse 2 laserproduct in overeenstemming met EN60825-1:2014



Waarschuwing!

Vermijd direct blikcontact. Het felle licht van de laserstraal kan tot letsel aan de ogen leiden en de ogen kortstondig verblinden.

Kijk niet in de laserstraal en richt niet onnodig op andere personen.

Andere personen niet verblinden.

Waarschuwing!

Het laserapparaat mag noch in de buurt van kinderen worden gebruikt noch mogen kinderen het apparaat gebruiken.

Opgelet! Een reflecterend oppervlak zou de laserstraal terug naar de bediener of een andere persoon kunnen reflecteren.

Houd een veilige afstand aan naar bewegende delen.

Verricht periodiek controlemetingen. Met name vlak voor, tijdens en na belangrijke metingen.

Pas op voor meetfouten als het instrument defect is of als het is gevallen, misbruikt of gemodificeerd.

Waarschuwing! Het gebruik van stuuerelementen of instellingen of de uitvoering van andere dan in de handleiding voorgeschreven processen kan leiden tot een gevaarlijke stralingsbelasting.

Het lasermeettoestel heeft een beperkt toepassingsbereik. (Zie hoofdstuk 'Technische gegevens'). Pogingen om buiten het maximale en minimale bereik te meten resulteren in onnauwkeurige resultaten. De toepassing onder ongunstige omstandigheden, zoals te grote hitte of koude, fel zonlicht, regen, sneeuw, mist of andere, het zicht belemmerende omstandigheden kan leiden tot onnauwkeurige meetresultaten.

Als het lasermeettoestel van een warme naar een koude omgeving wordt gebracht (of omgekeerd), moet u even

wachten totdat het toestel zich aan de nieuwe omgevingstemperatuur heeft kunnen aanpassen.

Bewaar het lasermeettoestel altijd in gesloten ruimten en bescherm het tegen schokken, vibraties of extreme temperaturen.

Bescherm het lasermeettoestel tegen stof, natheid en te hoge luchtvochtigheid. Deze factoren zouden inwendige onderdelen onherstelbaar kunnen beschadigen of de nauwkeurigheid negatief kunnen beïnvloeden.

Gebruik geen agressieve reinigingsmiddelen of oplosmiddelen. Reinig het toestel uitsluitend met een schone, zachte doek.

Voorkom harde stoten en laat het toestel niet vallen. De nauwkeurigheid van het toestel dient te worden gecontroleerd als het gevallen is of aan andere mechanische belastingen werd blootgesteld.

Vereiste reparaties aan dit laserapparaat mogen alleen worden uitgevoerd door geautoriseerd vakpersoneel.

Gebruik het instrument niet in ruimten met explosiegevaar of in een agressieve omgeving.



Lege batterijen mogen niet bij het huisvuil worden weggegooid. Denk aan het milieu en lever ze in bij de beschikbare inzamelpunten in overeenstemming met nationale en lokale regels. Het product mag niet bij het huisvuil worden weggegooid. Het product moet in overeenstemming met de nationale regelgeving van uw land worden verwijderd. Houdt u aan de nationale en landspecifieke regelgeving. Neem voor informatie over de afvoer contact op met uw gemeente of vakhandelaar.



CE-keurmerk

TECHNISCHE GEGEVENS

	LDM 45	LDM 100
Optiek	15 mm x 9 mm	18 mm
Meetbereik		
Minimale afstand	45 m (Tolerantie: 45,1 m)	100 m (Tolerantie: 101 m)
Maximale afstand	0,05 m	0,05 m
Afstandsmeting		
Karakteristieke tolerantie (geldig voor 100 % reflecterend doel (witgelakte muur), geringe achtergrondverlichting, 25 °C)	± 2,0 mm (houd rekening met een extra tolerantie van 0,1 mm/m)	± 2,0 mm (houd rekening met een extra tolerantie van 0,1 mm/m)
Maximale tolerantie (geldig voor doelen met een geringere reflectie, hoge achtergrondverlichting of temperaturen die dichter bij de onderste/hogste waarden liggen)	± 4,0 mm (houd rekening met een extra tolerantie van 0,15 mm/m)	± 4,0 mm (houd rekening met een extra tolerantie van 0,15 mm/m)
Kleinste weergave-eenheid	1,0 mm	1,0 mm
Laserpuntgrootte		
16 m afstand:	25 x 50 mm	25 x 50 mm
Laserklasse	2	2
Lasertype	635 nm, < 1 mW	635 nm, < 1 mW
Laserstraal		
verticale hoek	+1 graad	+1 graad
horizontale hoek	±1 graad	±1 graad
Displaytype	lcd (25 mm x 25 mm)	lcd (25 mm x 25 mm)
Automatische uitschakeling laser	90 seconden	90 seconden
Automatische uitschakeling toestel	180 seconden	180 seconden
Stroomvoorziening	AAA 2x (alkaline-batterij)	AAA 2x (alkaline-batterij)
Batterijlevensduur	10.000 (afzonderlijke metingen)	10.000 (afzonderlijke metingen)
Arbeidstemperatuurbereik	-0°C tot +40°C	-0°C tot +40°C
Opslagtemperatuurbereik	-10°C tot +60°C	-10°C tot +60°C
Gewicht zonder batterij	87 g	122 g
Veiligheidsklasse	IP54 (tegen stof en spatwater beschermd)	IP54 (tegen stof en spatwater beschermd)

VOORGESCHREVEN GEBRUIK VAN HET SYSTEEM

Het lasermeettoestel is geschikt voor het meten van afstanden en neigingen.
Dit apparaat uitsluitend gebruiken voor normaal gebruik, zoals aangegeven.

TABEL MET STORINGSCODES

Code	Beschrijving	Maatregel
Err500	Hardwareproblemen	Schakel het meetapparaat uit en weer in. Als het probleem blijft bestaan, kunt u het meetapparaat naar het dichtstbijzijnde servicepunt brengen.

OVERZICHT

STATUSBALK

- ▶ Referentiemeetpunt, soort meting, meethoek (alleen met LDM 100), meetniveau (alleen met LDM 100)

DISPLAY

- ▶ Menu
- ▶ Metingen
- ▶ Instellingen

NAAR BOVEN / OPTELLEN

- ▶ In het menu naar boven schakelen
- ▶ Waarde optellen

METING / OK

- ▶ Laser inschakelen
- ▶ Meetwaarde opslaan
- ▶ OK in het menu selecteren

MENU

- ▶ Geschiedenis
- ▶ Meting
- ▶ Instellingen

NAAR BENEDEN / AFTREKKEN

- ▶ In het menu naar beneden schakelen
- ▶ Waarde aftrekken

WISSEN / IN-/UITSCHAKELEN

- ▶ AAN / UIT (toets ingedrukt houden totdat het apparaat een signaalgeluid genereert)
- ▶ Meetwaarde wissen

MEETPUNT

- ▶ Achter (standaardinstelling)
- ▶ Voor
- ▶ Hoek (wordt automatisch geactiveerd door uitklappen van de pen)

METEN

- ▶ Laser inschakelen
- ▶ Meetwaarde opslaan

BATTERIJEN VERVANGEN

- ▶ Batterijen vervangen als het batterijsymbool knippert.

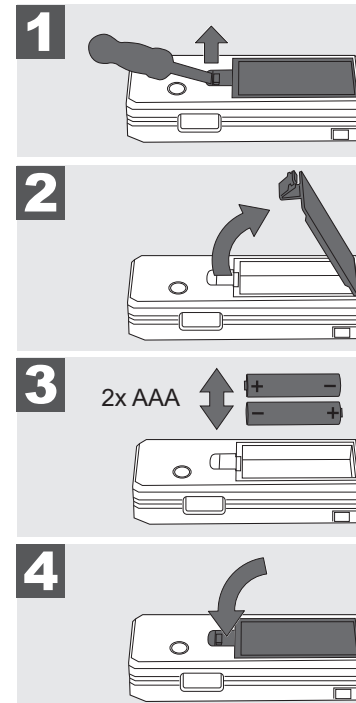

STATIEF

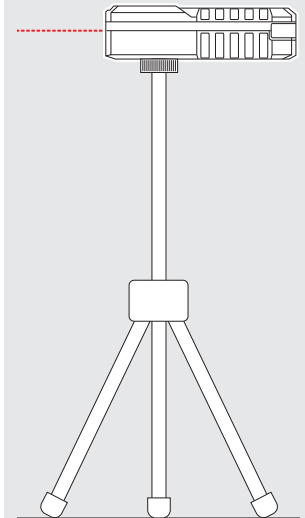

HOEKPEN

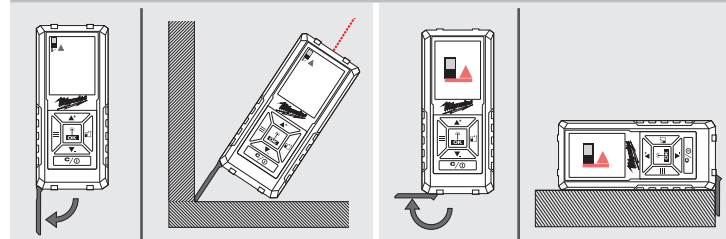

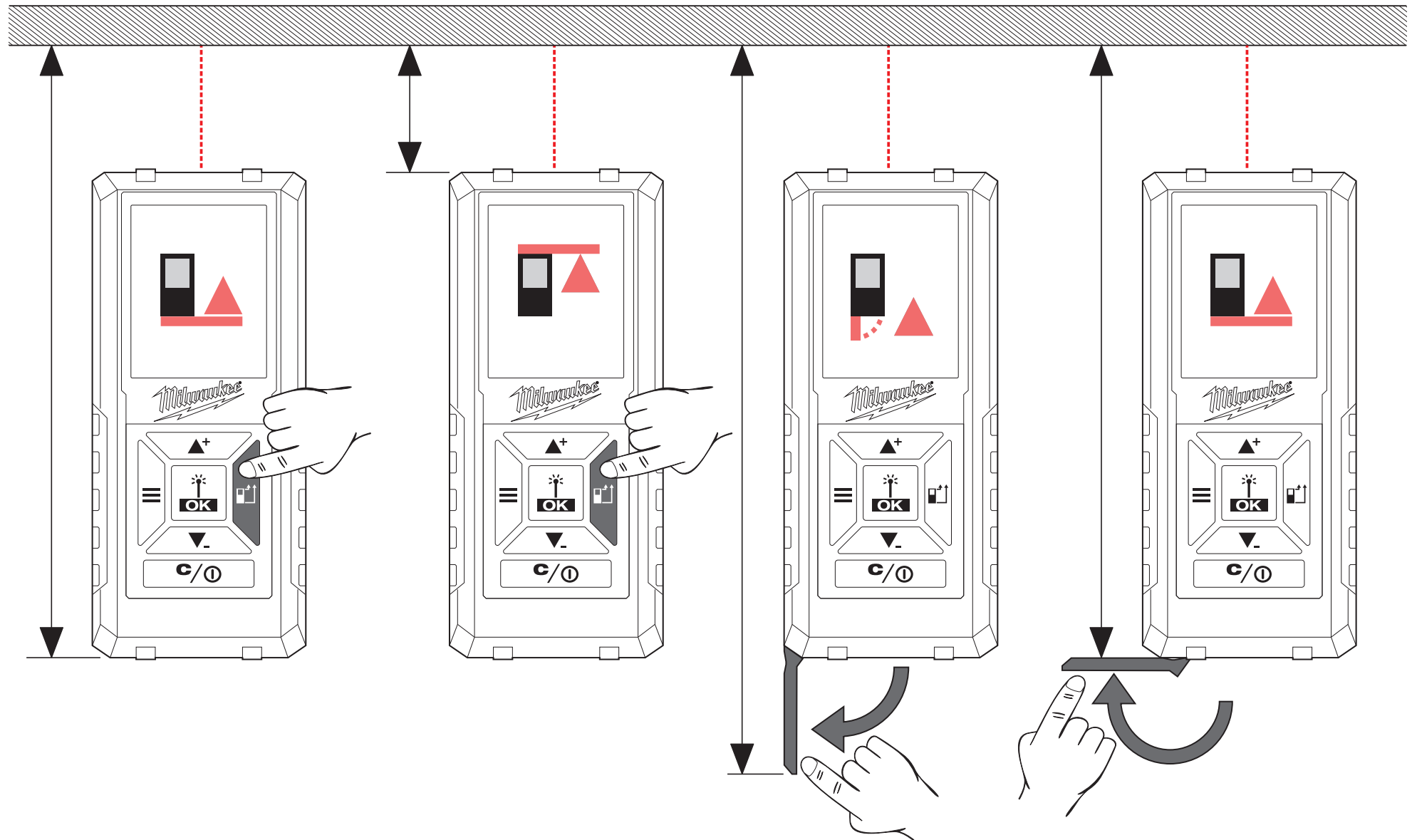

MENU

GESCHIEDENIS



Weergave van de afgelopen 30 metingen / berekeningen.

De afzonderlijke metingen voor de berekening van oppervlak, totaal oppervlak, volume enz. worden niet onder GESCHIEDENIS opgeslagen, hier wordt alleen het resultaat van de berekeningen opgeslagen.

Druk op de toets C/AAN/UIT om een invoer te wissen.

Bij de onder GESCHIEDENIS opgeslagen waarden kunnen metingen/berekeningen worden opgeteld of afgetrokken. Het is alleen mogelijk om berekeningen van dezelfde soort uit te voeren (lengte, oppervlak, volume enz.).

Uitvoeren van een berekening:

1. Gebruik de toetsen ▲+ ▼- om een meetmodus uit de GESCHIEDENIS te selecteren.
2. Druk op de OK-toets.
3. Voer de voor de berekening vereiste metingen uit.
4. Druk op de toets OK om de nieuwe berekeningen onder GESCHIEDENIS op te slaan.

METING

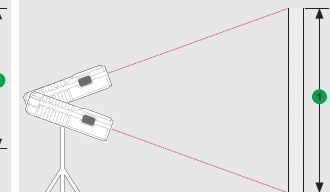
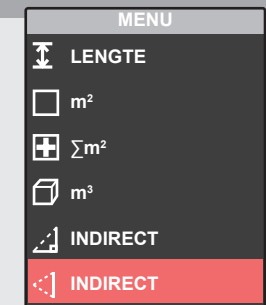
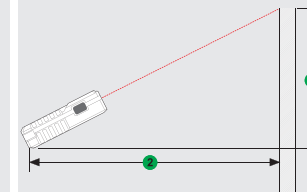
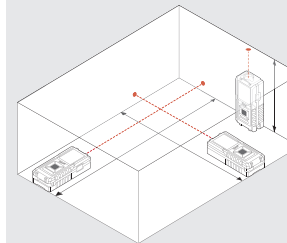
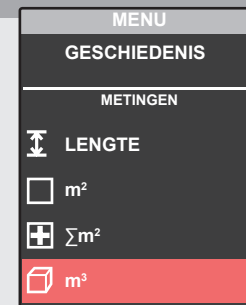
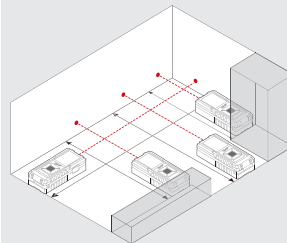
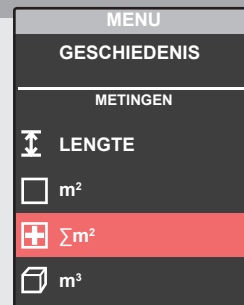
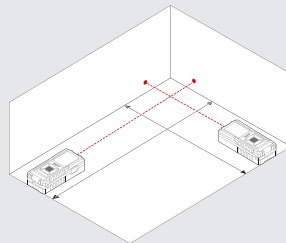
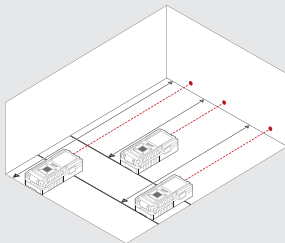

INSTELLINGEN

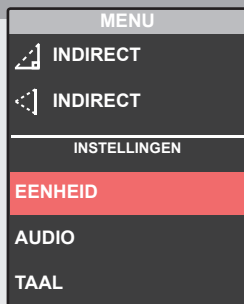

Selecteer de gewenste maateenheid.

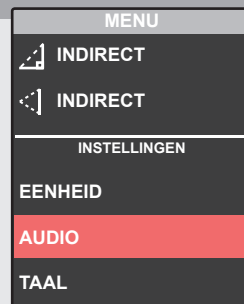



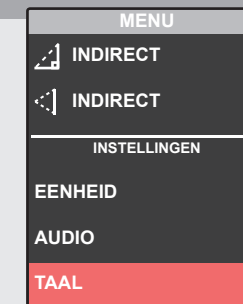

Signaalgeluid aan/uit.

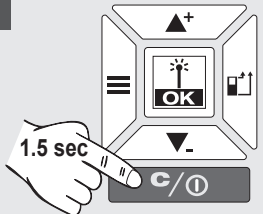
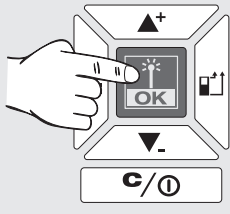
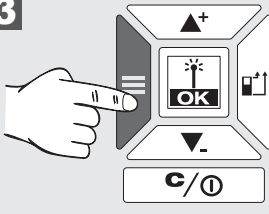
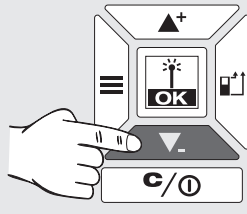
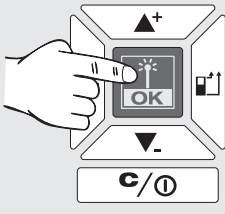

Taal selecteren.

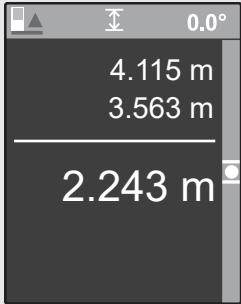
STARTEN

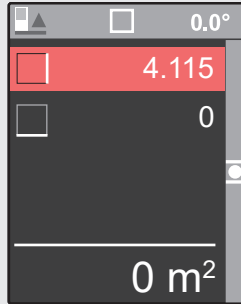
<p>1</p> 	<p>2</p> 	<p>3</p> 	<p>4</p> 	<p>5</p> 
 				
<p>Na het inschakelen wordt automatisch de MODUS VOOR DE LENGTEMETING geactiveerd.</p>	<p>Voer een LENGTEMETING uit of ...</p>	<p>... druk op de menu-toets om naar het menu te schakelen ...</p>	<p>... en selecteer een andere bedrijfsmodus met behulp van de toetsen ▲+ ▼- en ...</p>	<p>... en activeer deze bedrijfsmodus door de toets OK in te drukken.</p>

LENGTE METEN

0

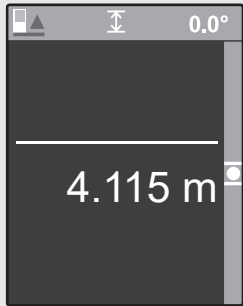

Meetwaarde wit = waarde gemeten

1

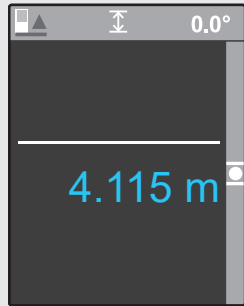
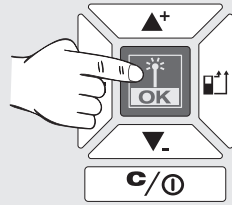

Meetwaarde blauw = waarde tijdelijk opgeslagen

2

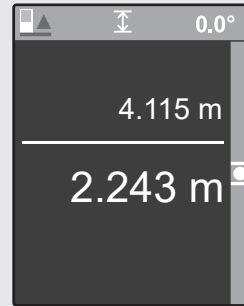
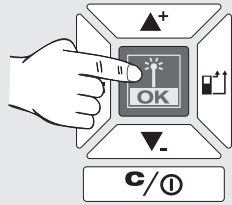

3

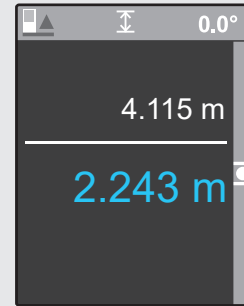
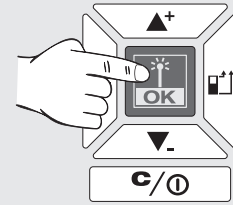

4

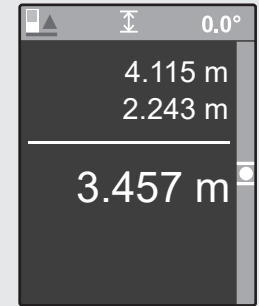
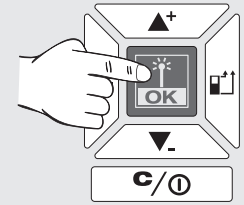

5

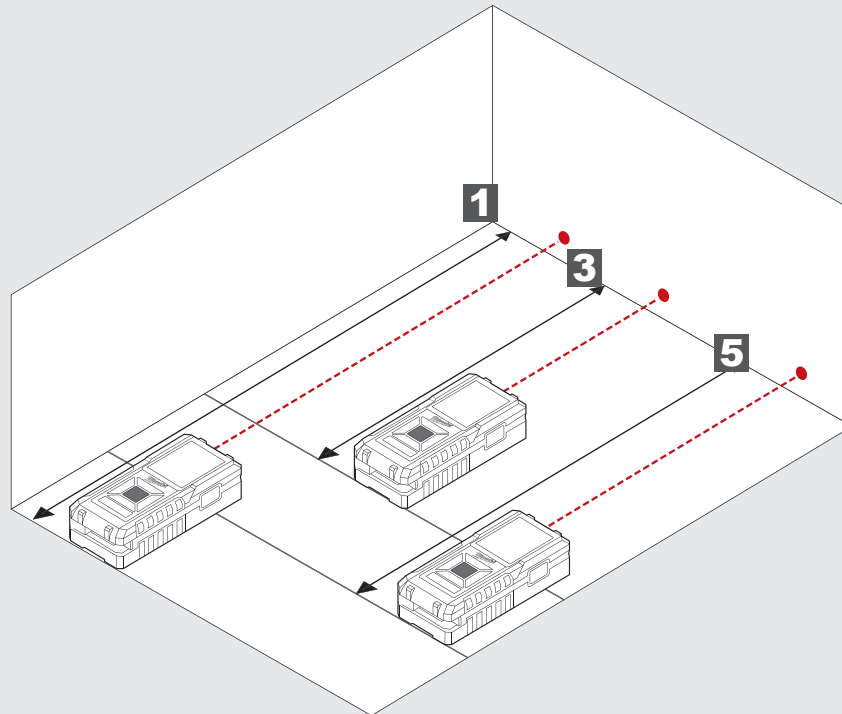
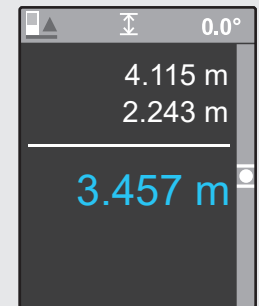
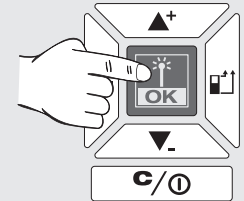

OPPERVLAK METEN

0

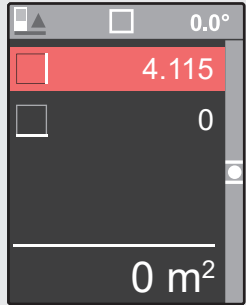

1

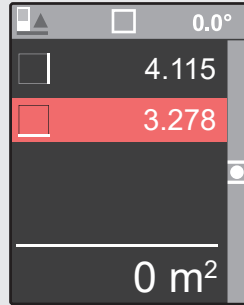
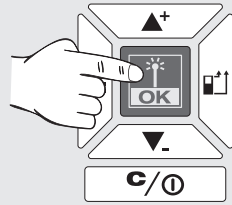

2

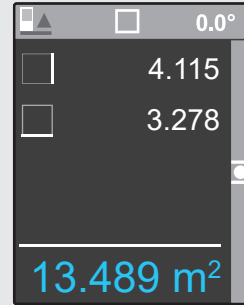
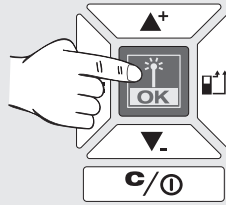

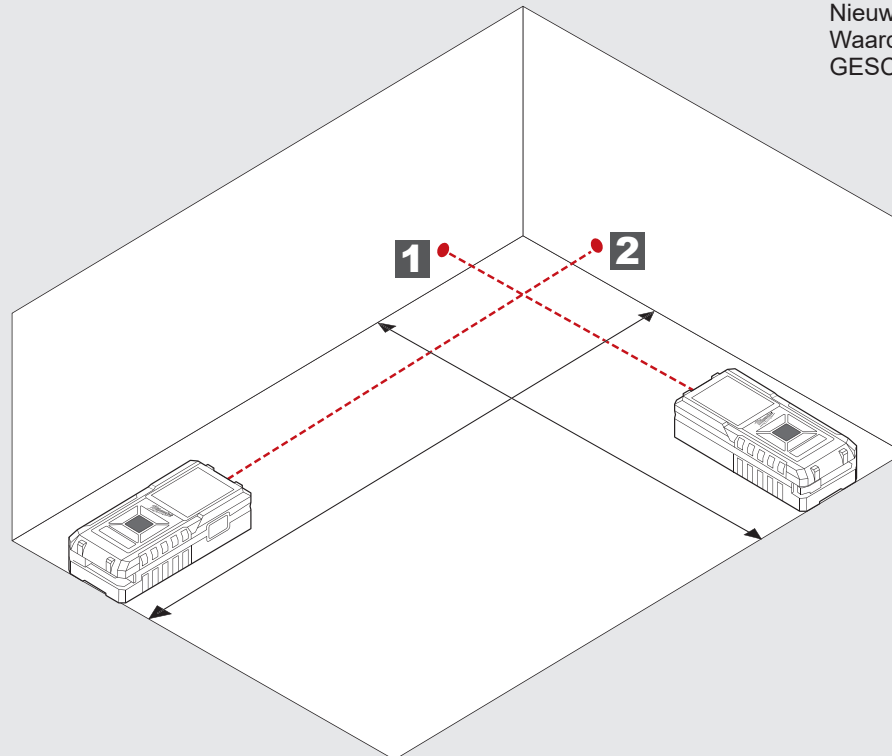
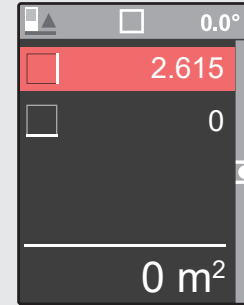
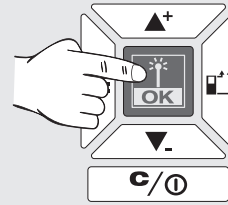

2



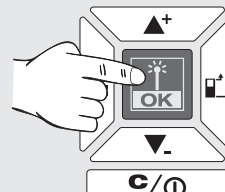
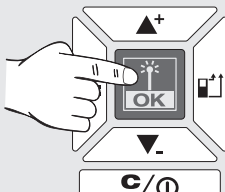
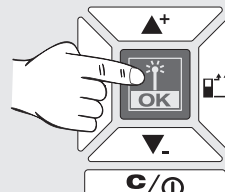
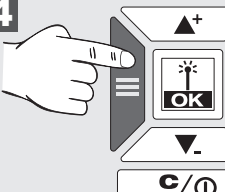
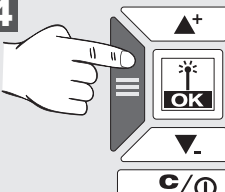

Nieuwe meting.
Waarde wordt opgeslagen onder
GESCHIEDENIS.

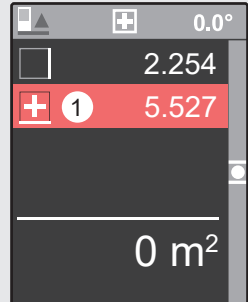
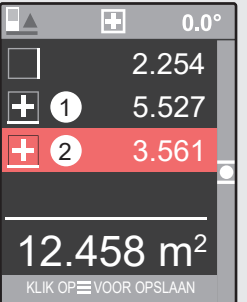
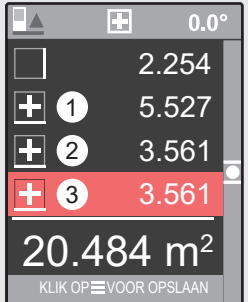
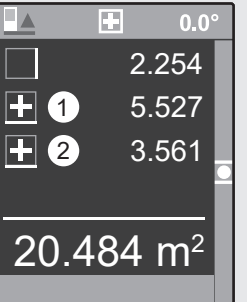
TOTAAL OPPERVLAK METEN

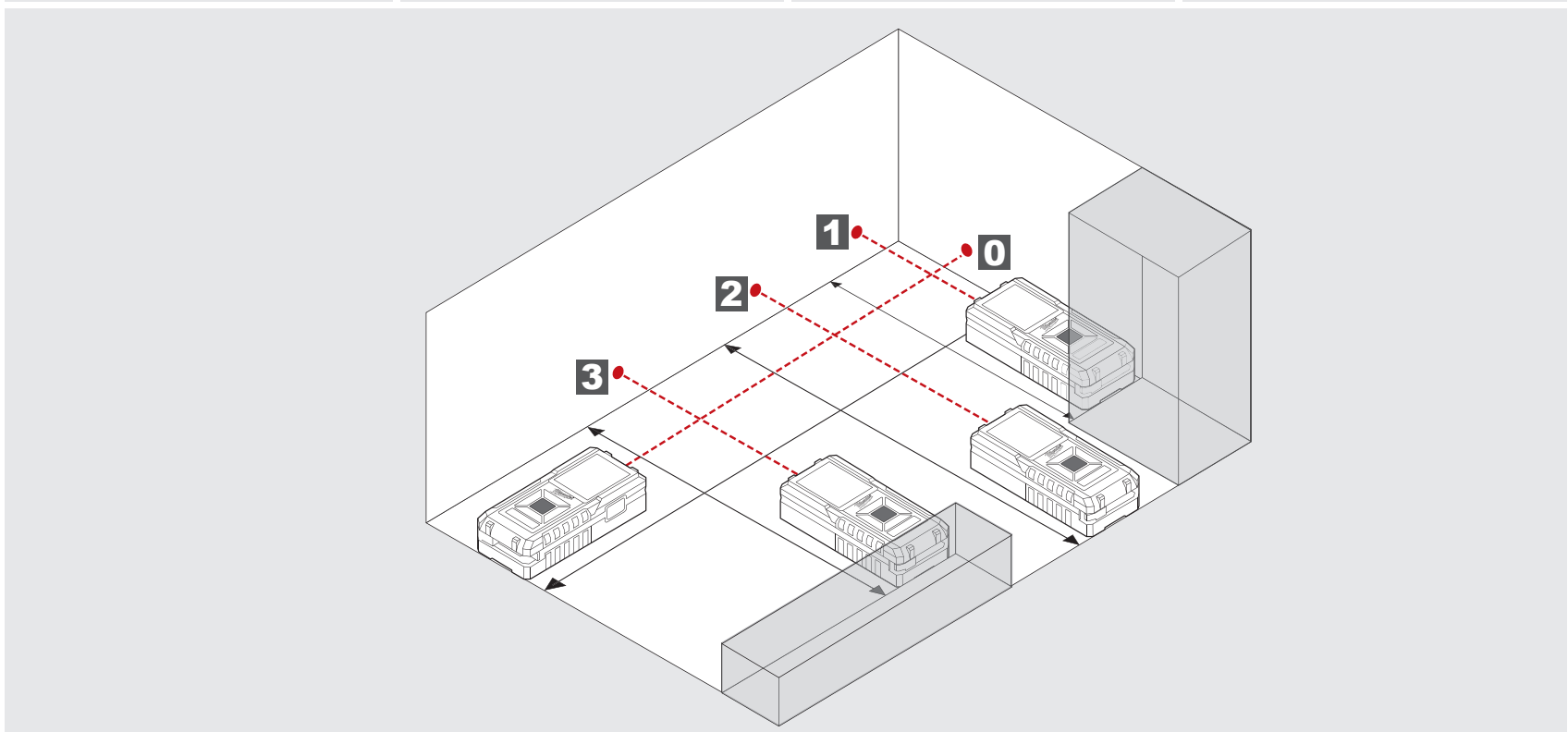
<p>0</p> 	<p>1</p> 	<p>2</p> 	<p>3</p> 	<p>4</p> 
				

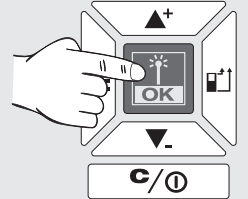

4

Nieuwe meting.
 Resultaat wordt opgeslagen onder
 GESCHIEDENIS.

VOLUME METEN

0

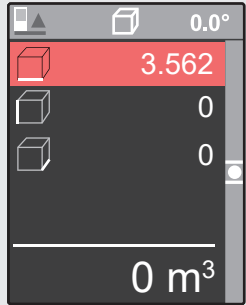

1

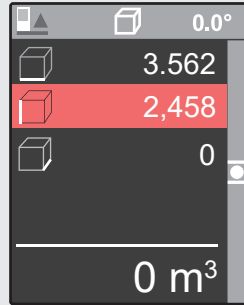
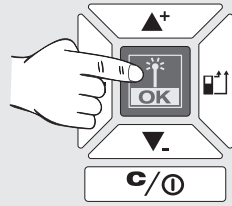

2

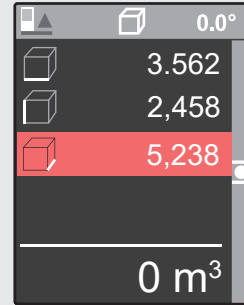
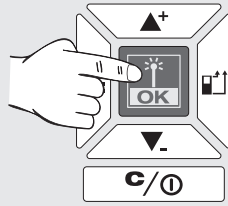

3

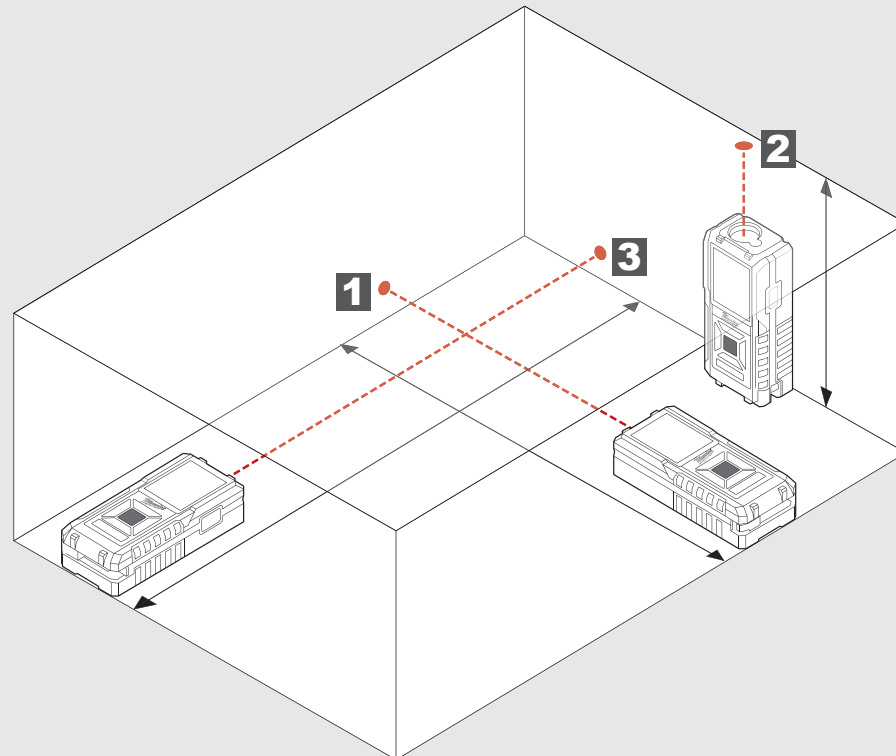
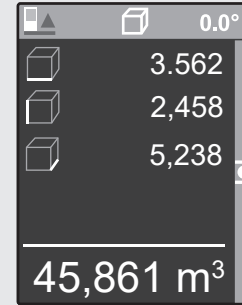
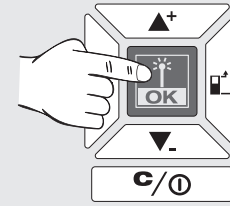

INDIRECTE HOOGTE-/LENGTEMETING (ALLEEN MET LDM 100)

0

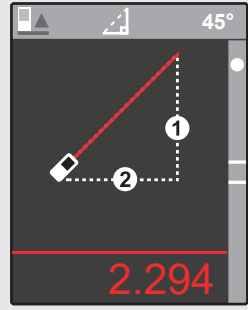

1

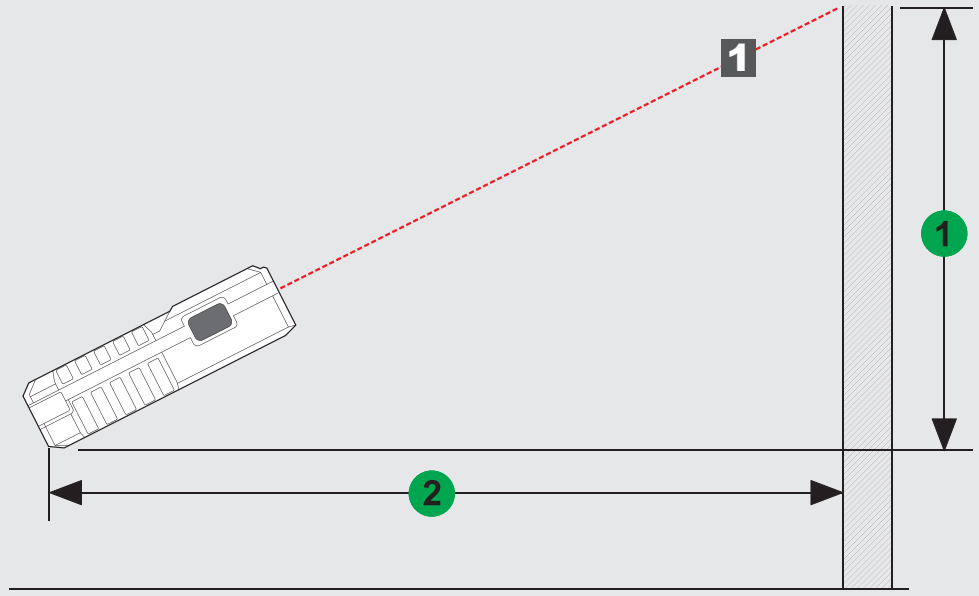
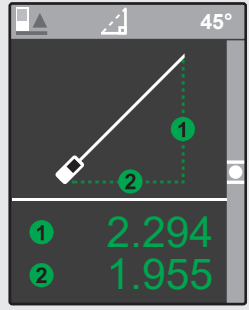
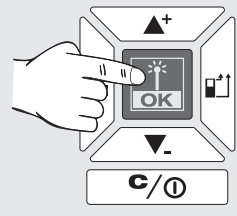

INDIRECTE HOOGTEMETING (ALLEEN MET LDM 100)

0

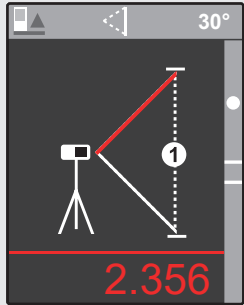

1

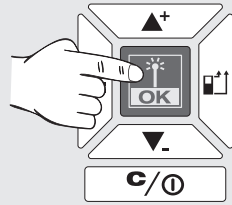

2

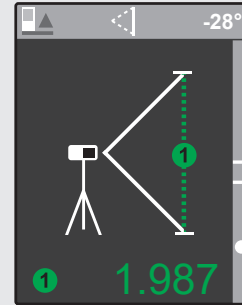
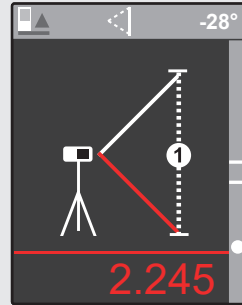
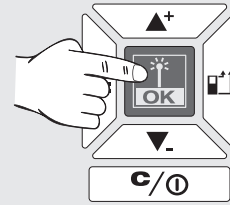

Gebruik een statief of een ander stabiel oppervlak om twee verschillende lengten te meten.

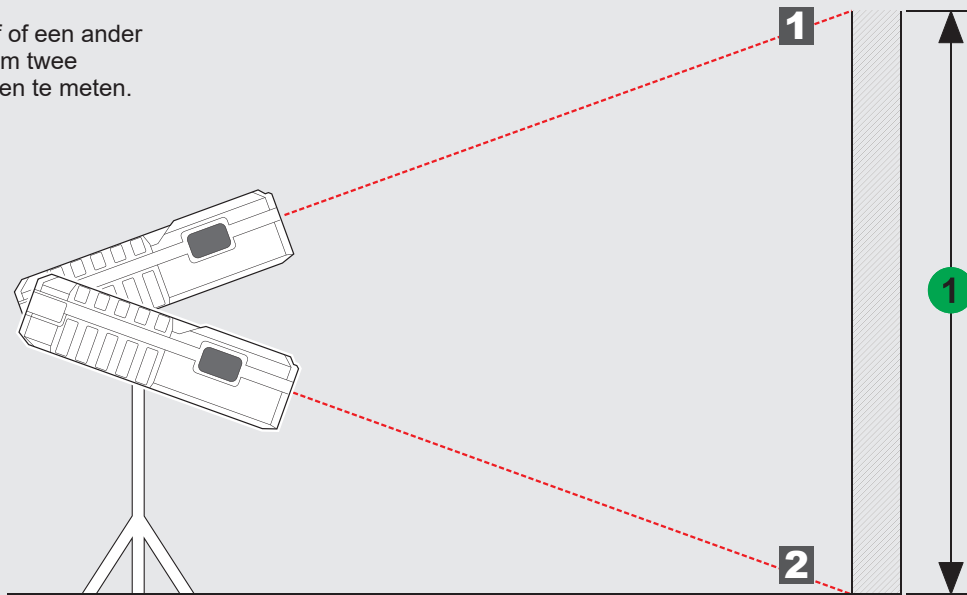

INDHOLD

Vigtige sikkerheds- instruktioner.....	1
Tekniske data.....	2
Tiltænkt Formål.....	2
Fejlkode Tabel	2
Oversigt	3
Målepunkt.....	4
Menu.....	5
Start	6
Måling af længde	7
Måling af areal	8
Måling af samlet areal	9
Måling af volumen	10
Indirekte højde-/længdemåling (kun med LDM 100)	11
Indirekte højdemåling (kun med LDM 100)	12

VIGTIGE SIKKERHEDS- INSTRUKTIONER



Brug ikke produktet før du har læst sikkerhedsinstruktionerne og brugervejledningen på vedlagte CD.

Laserklassificering

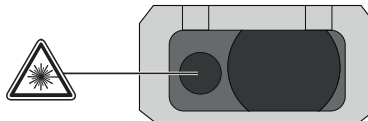

ADVARSEL:

Det er et Klasse 2 laserprodukt i overensstemmelse med EN60825-1:2014



Advarsel:

Undgå en direkte synskontakt. Laserstrålen kan forårsage blizt blindhed og føre til en kortvarig blænding.

Se aldrig ind i laserstrålen og ret den ikke unødigt mod andre personer.

Blænd ikke andre personer.

Advarsel:

Betjen ikke laserapparatet i nærheden af børn eller tillad ikke børn at benytte laserapparatet.

OBS!! En reflekterende overflade kunne reflektere laserstrålen tilbage til brugeren eller andre personer.

Hold arme og ben i sikker afstand fra bevægelige dele.

Udfør regelmæssige testmålinger. Især før, under og efter vigtige målinger.

Vær opmærksom på fejl-målinger, hvis produktet er defekt, eller hvis det er blevet tabt eller er blevet misbrugt eller modificeret.

Advarsel: Anvendelse af andre styreelementer, indstillinger eller procedurer end angivet her i manualen kan føre til farlig strålebelastning.

Laserafstandsmåleren har grænser for sit anvendelsesområde. (Se afsnittet Tekniske data). Det vil forårsage unøjagtigheder at forsøge at måle uden for det maksimale og minimale område. Bruges instrumentet ved ugunstige betingelser som hvis det er for varmt eller for koldt, meget kraftigt sollys, regn, sne, tåge eller andre sigtbegrænsende betingelser kan det føre til unøjagtige målinger.

Hvis laserafstandsmåleren kommer fra varme omgivelser til kolde (eller omvendt), så vent, indtil den har tilpasset sig til den nye omgivelsestemperatur.

Opbevar altid laserafstandsmåleren indendørs, beskyt den mod stød, vibrationer eller ekstreme temperaturer.

Beskyt laserafstandsmåleren mod støv, fugtighed og høj luftfugtighed. Dette kan ødelægge indvendige komponenter eller påvirke nøjagtigheden.

Brug ikke aggressive rengøringsmidler eller opløsningsmidler. Rengør kun instrumentet med en ren, blød klud.

Undgå at laserafstandsmåleren udsættes for kraftige stød eller at tabe den. Instrumentets nøjagtighed skal kontrolleres, hvis det er faldet ned eller har været udsat for andre mekaniske belastninger.

Nødvendige reparationer på dette laserapparat skal udføres af autoriserede fagfolk.

Brug ikke produktet i områder med eksplosions-fare eller under barske forhold.



Brugte batterier må ikke smides ud med husholdningsaffaldet. Skån miljøet og tag dem til opsamlingsstederne i overensstemmelse med nationale eller lokale regler. Produktet må ikke smides ud med husholdningsaffaldet. Smid produktet ud i overensstemmelse med de gældende nationale regler i dit land. Følg de nationale og landespecifikke regler. Henvend dig til de lokale myndigheder eller din forhandler for at få oplysning om bortskaffelsen.



CE-mærke

TEKNISKE DATA

	LDM 45	LDM 100
Modtagelinse	15 mm x 9 mm	18 mm
Måleområde		
Minimal afstand	45 m (Tolerance: 45,1 m)	100 m (Tolerance: 101 m)
Maksimal afstand	0,05 m	0,05 m
Afstandsmåling		
Typisk tolerance (gælder for 100 % målrefleksion (hvidmalet væg), svag baggrundsbelysning, 25 °C)	± 2,0 mm (der bør tages højde for en yderligere tolerance på 0,1 mm/m)	± 2,0 mm (der bør tages højde for en yderligere tolerance på 0,1 mm/m)
Maksimal tolerance (gælder for måloverflader med svag refleksion, kraftig baggrundsbelysning eller temperaturer, som nærmer sig højeste/laveste værdi)	± 4,0 mm (der bør tages højde for en yderligere tolerance på 0,15 mm/m)	± 4,0 mm (der bør tages højde for en yderligere tolerance på 0,15 mm/m)
Mindste visbare enhed	1,0 mm	1,0 mm
Laserpunktstørrelse		
16 meters afstand:	25 x 50 mm	25 x 50 mm
Laserklasse	2	2
Lasertype	635 nm, < 1 mW	635 nm, < 1 mW
Laserstråle		
vertikalvinkel	+1 grad	+1 grad
horisontalvinkel	±1 grad	±1 grad
Display type	LCD (25 mm x 25 mm)	LCD (25 mm x 25 mm)
Automatisk slukning af laser	90 sekunder	90 sekunder
Automatisk slukning af instrumentet	180 sekunder	180 sekunder
Strømforsyning	AAA 2x (alkaline batteri)	AAA 2x (alkaline batteri)
Batteriets levetid	8000 (enkelt måling)	8000 (enkelt måling)
Arbejdstemperatur område	-0°C op til +40°C	-0°C op til +40°C
Opbevaringstemperatur område	-10°C op til +60°C	-10°C op til +60°C
Vægt uden batteri	87 g	122 g
Kapslingsklasse	IP54 (støv- og stænkvangdsbeskyttet)	IP54 (støv- og stænkvangdsbeskyttet)

TILTÆNKT FORMÅL

Laserafstandsmåleren er egnet til måling af afstande og hældninger.
Produktet må ikke anvendes på anden måde og til andre formål end foreskrevet.

FEJLKODE TABEL

Kode	Beskrivelse	Løsning
Err500	Hardwareproblemer	Sluk for afstandsmåleren og tænd for den igen. Hvis problemet stadig er der, så indlever afstandsmåleren til nærmeste serviceforhandler.

OVERSIGT

STATUSLISTE

- ▶ Referencemålepunkt, målingstype, målevinkel (kun med LDM 100), måleniveau (kun med LDM 100)

DISPLAY

- ▶ Menu
- ▶ Målinger
- ▶ Indstillinger

OP / ADDÉR

- ▶ Gå op i menuen
- ▶ Addér værdi

MÅLING / OK

- ▶ Tænd for laser
- ▶ Gem måleværdi
- ▶ Vælg OK i menuen

MENU

- ▶ Historik
- ▶ Måling
- ▶ Indstillinger

NED / SUBTRAHER

- ▶ Gå ned i menuen
- ▶ Subtrahér værdi

SLET / TÆND/SLUK

- ▶ TÆND/SLUK (hold tasten nede, indtil der lyder en signaltone fra enheden)
- ▶ Slet måleværdi

MÅLEPUNKT

- ▶ Bagved (standardindstilling)
- ▶ Foran
- ▶ Hjørne (aktiveres automatisk via udklapning af armen)

MÅLING

- ▶ Tænd for laser
- ▶ Gem måleværdi

SKIFT BATTERIER

- ▶ Skift batterier, når batterisymbolet blinker.

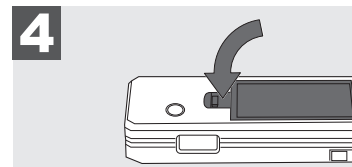
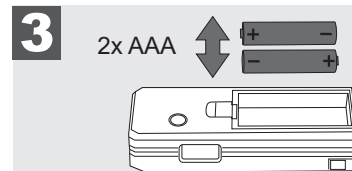
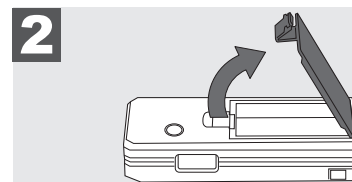
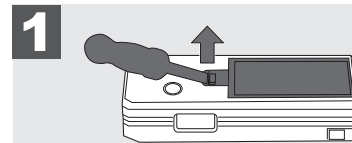

STATIV

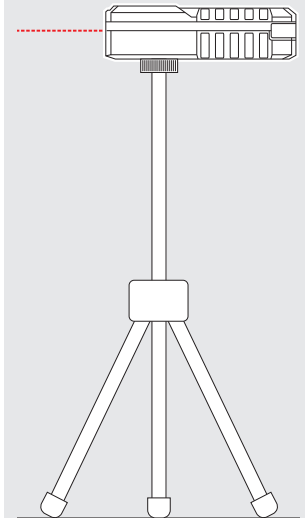

HJØRNESTIFT

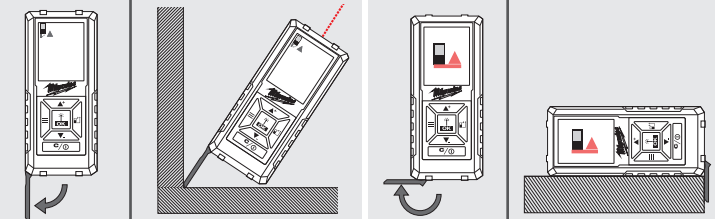

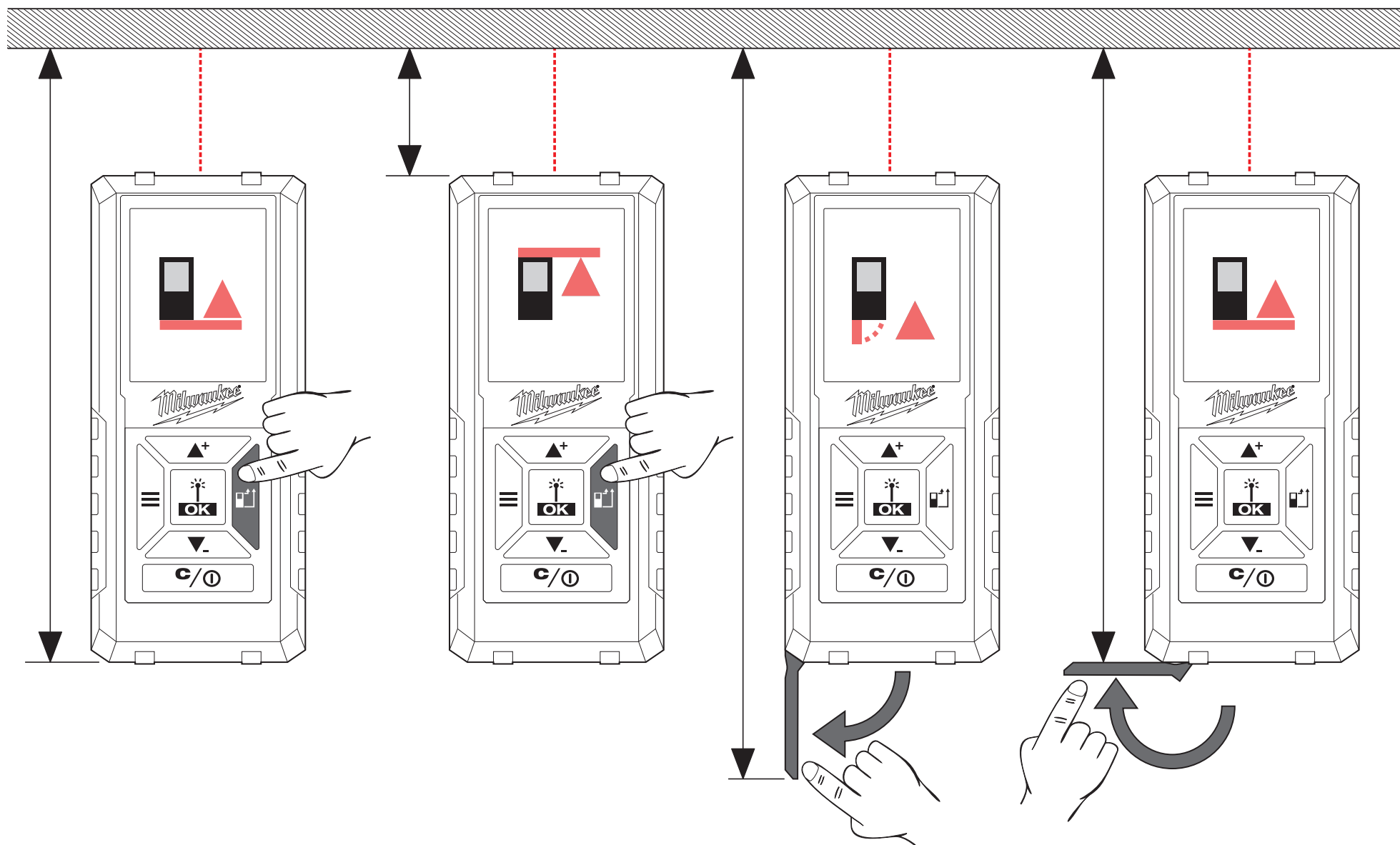

MENU

HISTORIK

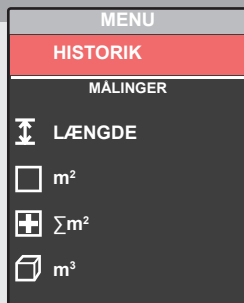

Visning af de sidste 30 målinger/beregninger

De enkelte målinger til beregning af overflade, samlet areal, volumen osv. gemmes ikke under HISTORIK, men kun resultatet af beregningerne.

Tryk på tast C/ TÆND/SLUK for at slette en registrering.

Der kan adderes eller subtraheres målinger/beregninger til/fra værdierne gemt under HISTORIK. Der kan kun udføres beregninger af samme type (længde, areal, volumen osv.).

Gennemførelse af en beregning:

1. Brug tasterne ▲+ ▼- til at vælge en individuel måling fra HISTORIK.
2. Tryk på OK-tasten.
3. Gennemfør de(n) måling(er), som er nødvendige til beregningen.
4. Tryk på tast OK for at gemme den nye beregning i HISTORIK.

MÅLING

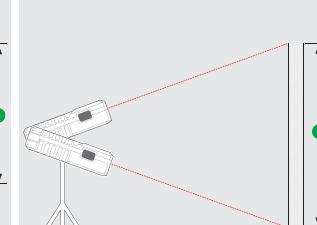
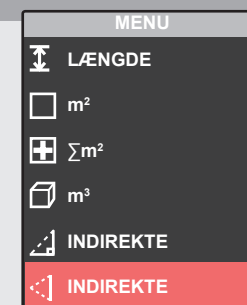
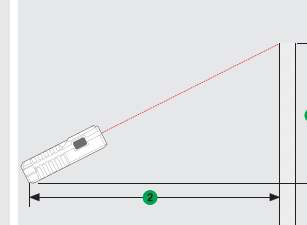
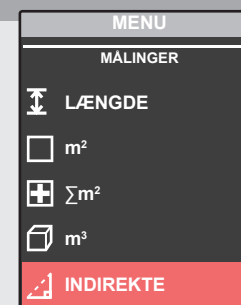
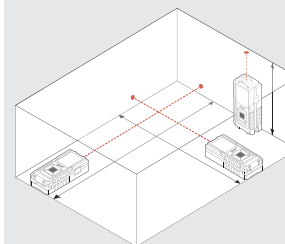
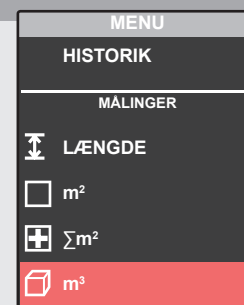
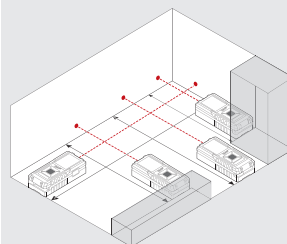
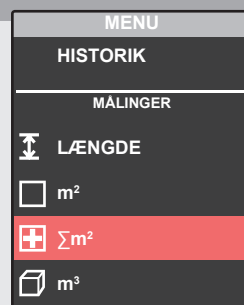
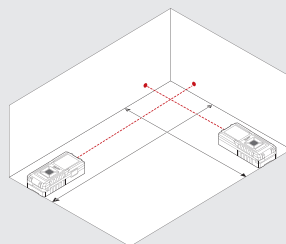
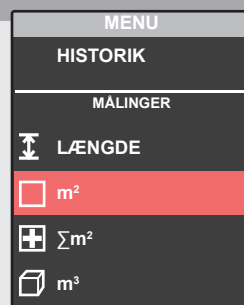
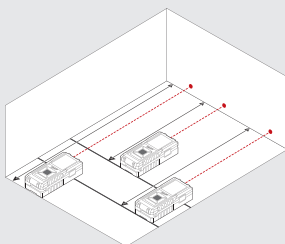
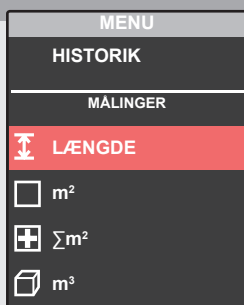

INDSTILLINGER

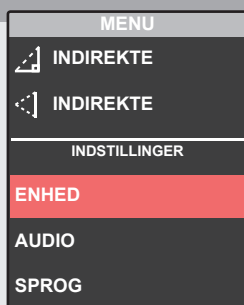

Vælg den ønskede måleenhed.

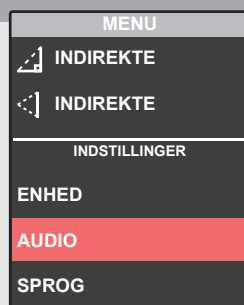

Signaltone til/fra.

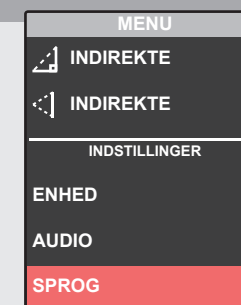

Vælg sprog.

START

1

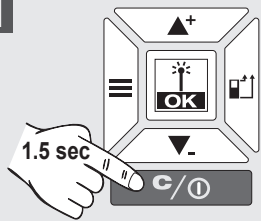

2

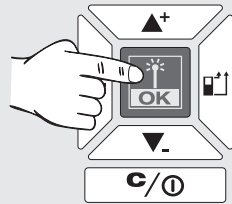

3

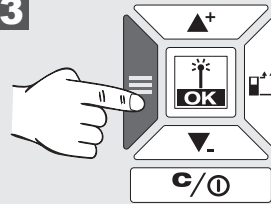

4

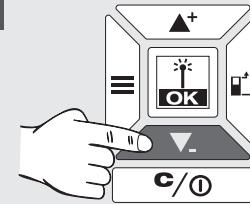

5

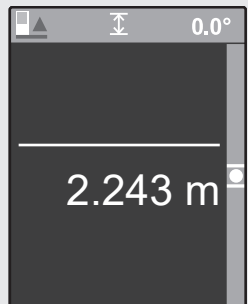
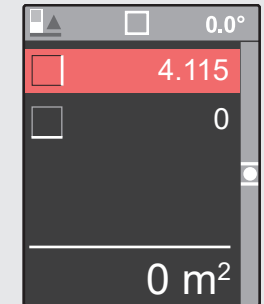
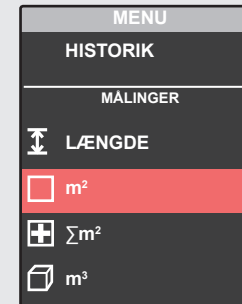
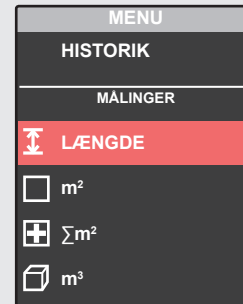
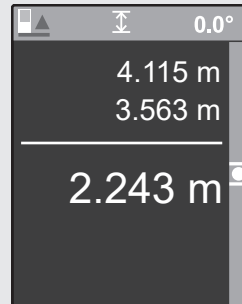
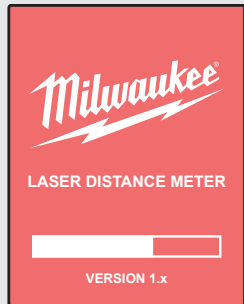
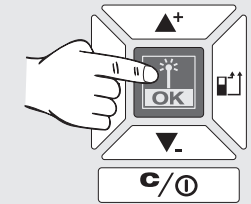

Efter tilkoblingen aktiveres LÆNGDEMÅLINGSSSENSOREN automatisk.



Udfør en LÆNGDEMÅLING eller ...

... tryk på menutasten for at skifte til menuen ...

... og vælg en ny driftsmåde ved hjælp af tasterne ▲+ ▼- og ...

... og aktivér driftsmåden ved at trykke på tasten OK.

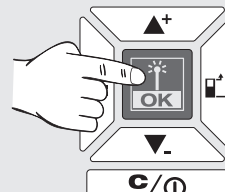
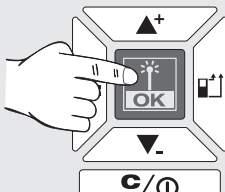
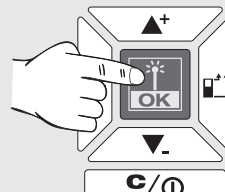
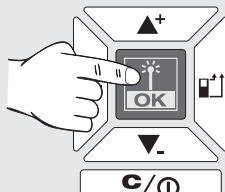
MÅLING AF LÆNGDE

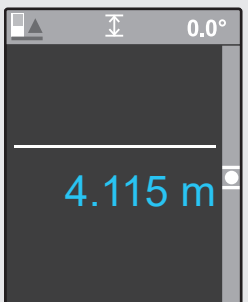
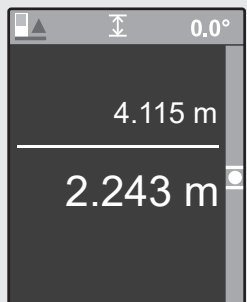
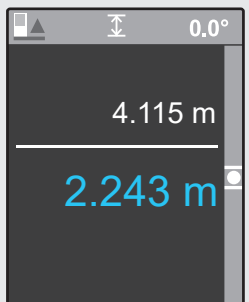
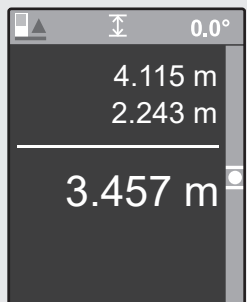
0	1 	2 	3 	4 
 <p>Måleværdi hvid = værdi målt</p>	 <p>Måleværdi blå = værdi gemt midlertidigt</p>			

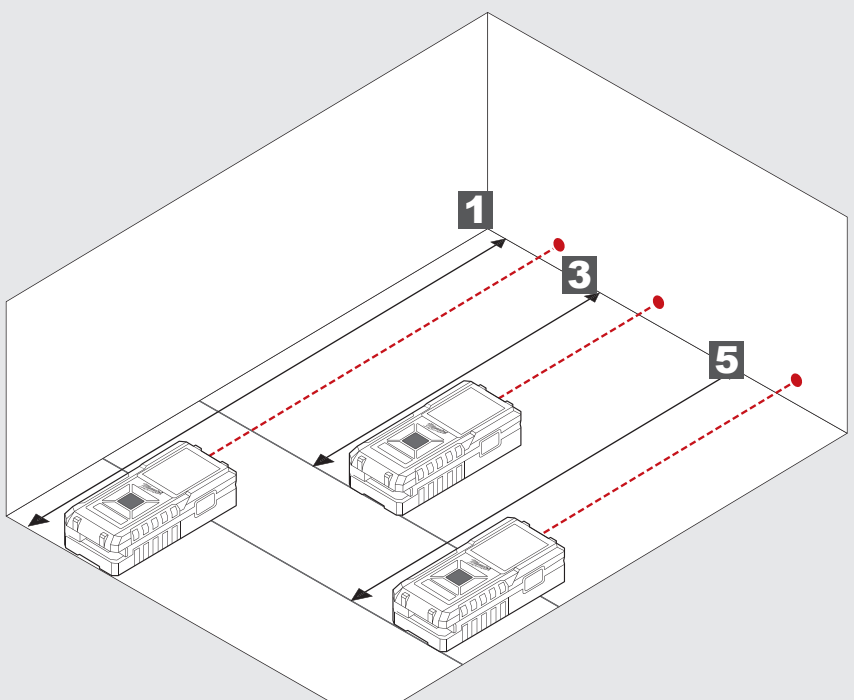

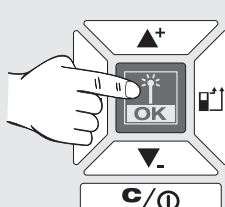
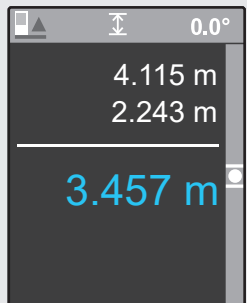
5

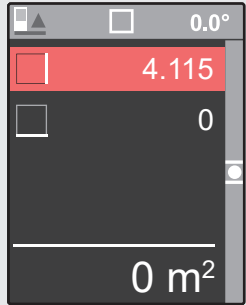

MÅLING AF AREAL

0

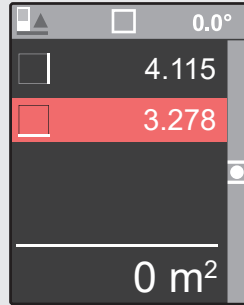
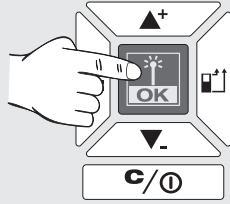

1



2

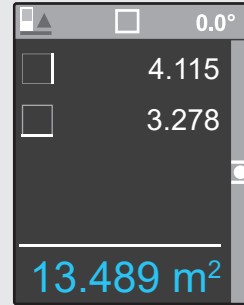
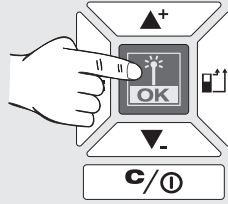

2

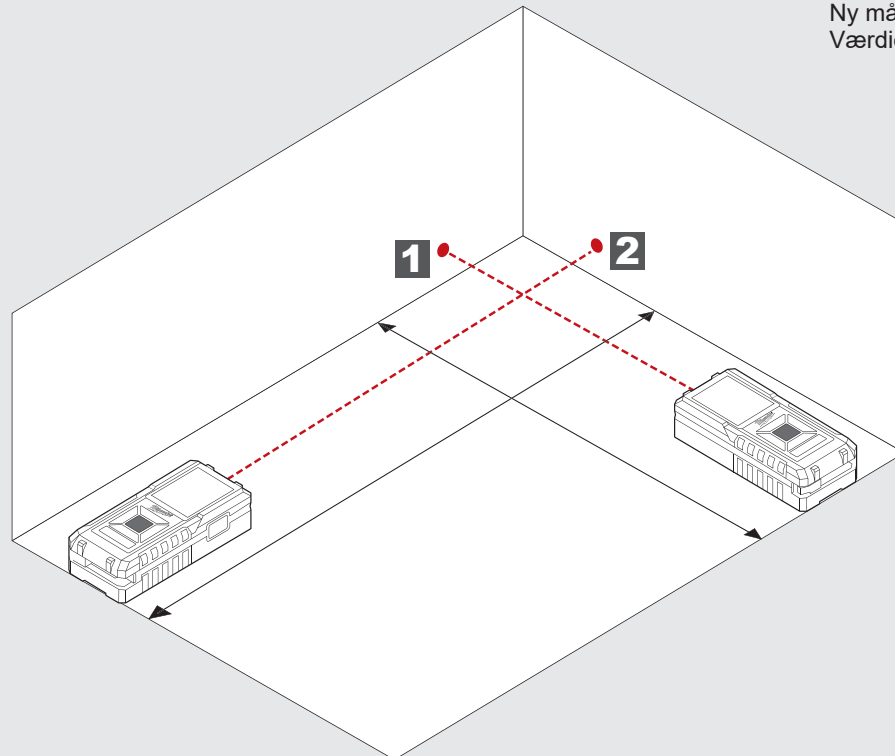
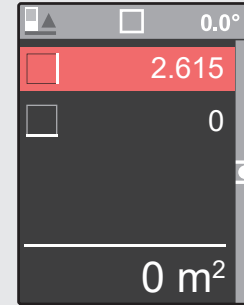
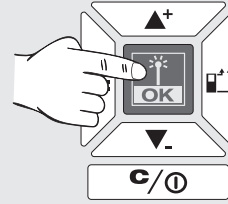

Ny måling.
Værdien gemmes under PROCES.

MÅLING AF SAMLET AREAL

0

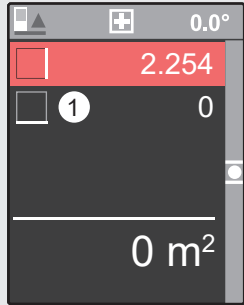

1

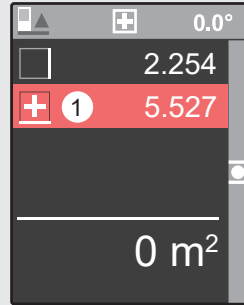
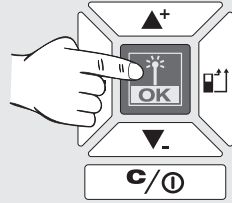

2

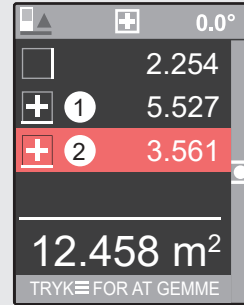
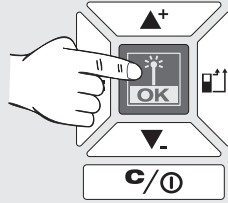

3

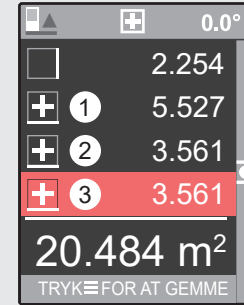
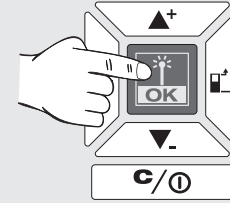

4

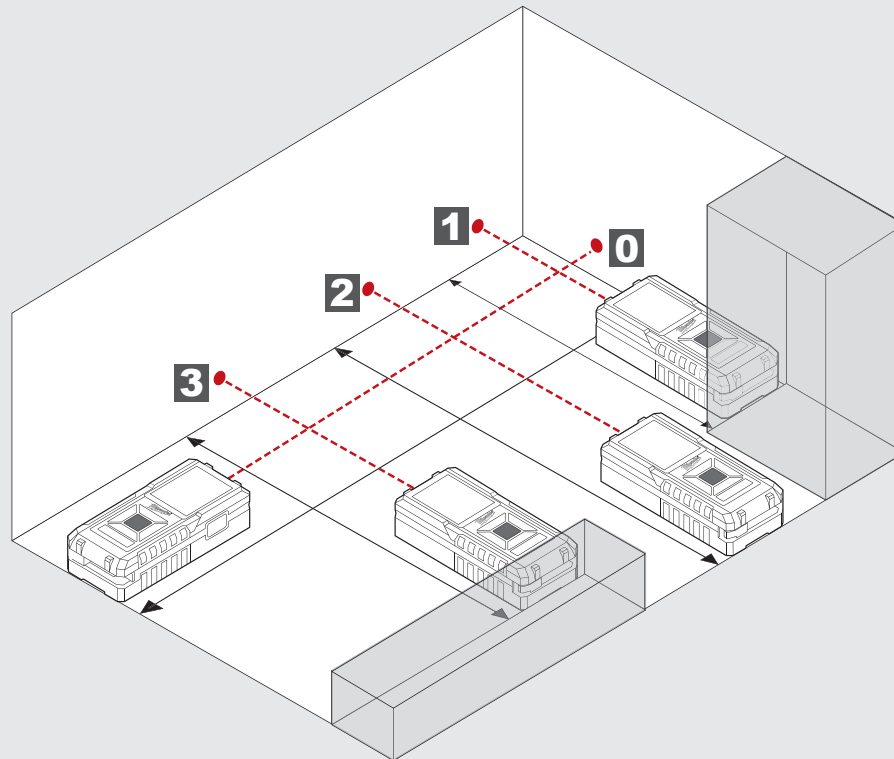
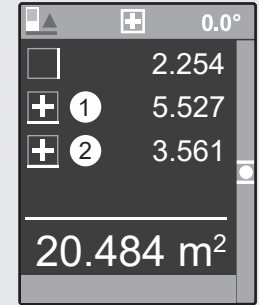
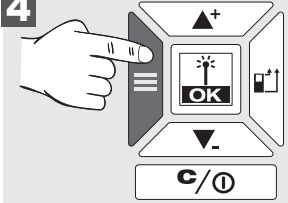

4

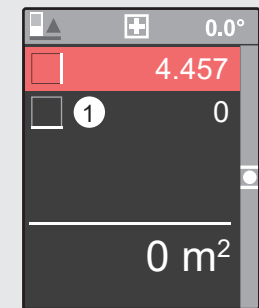
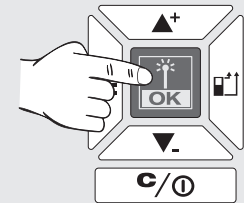

Ny måling.
Resultatet gemmes under PROCES.

MÅLING AF VOLUMEN

0

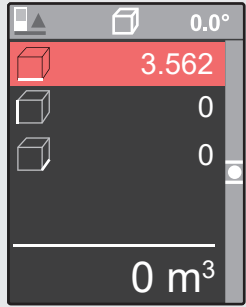

1

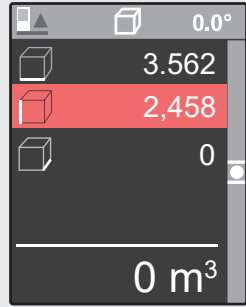
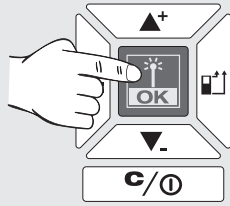

2

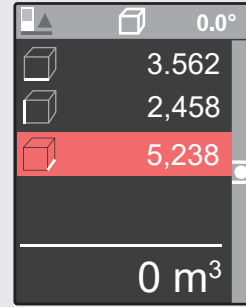
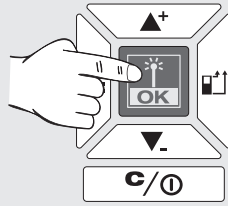

3

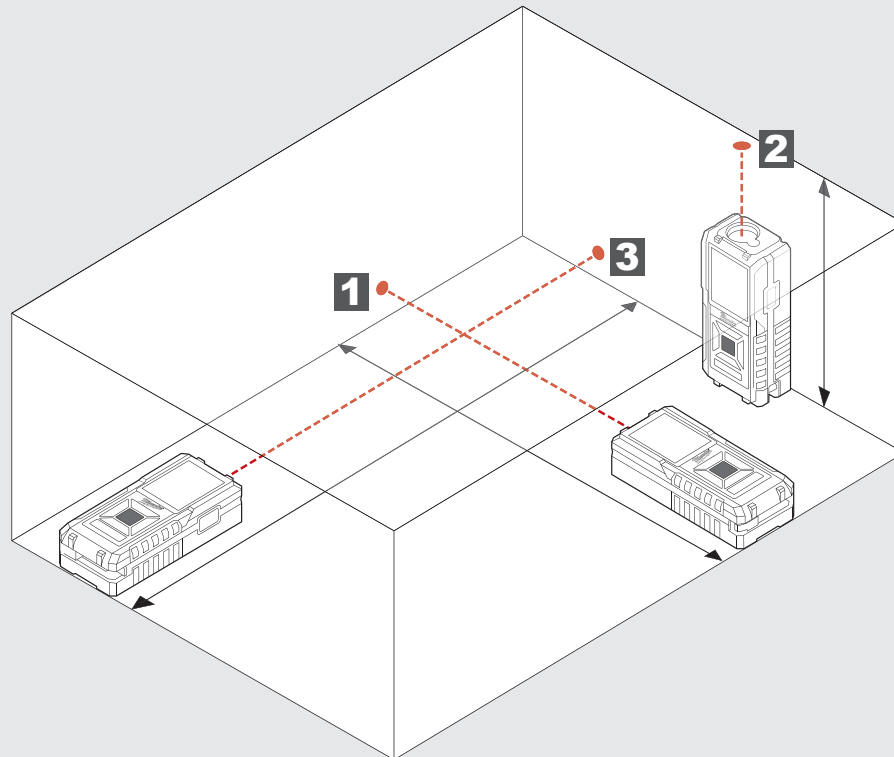
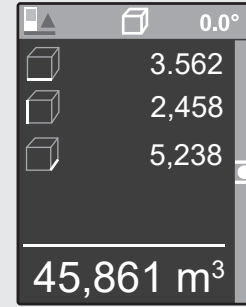
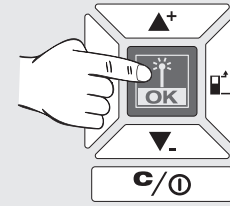

INDIREKTE HØJDE-/LÆNGDEMÅLING (KUN MED LDM 100)

0

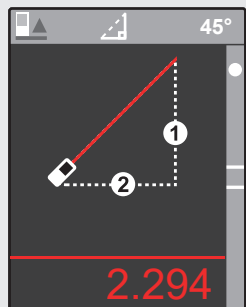

1

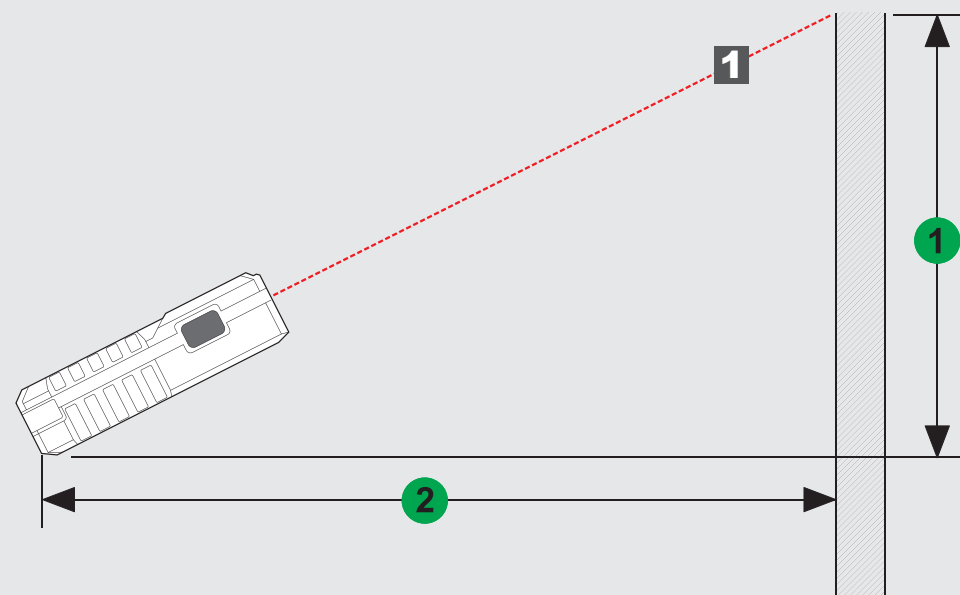
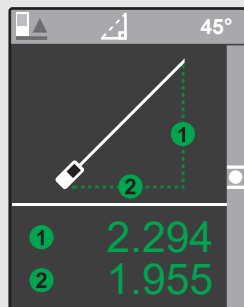
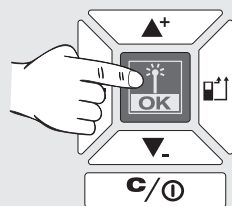

INDIREKTE HØJDEMÅLING (KUN MED LDM 100)

0

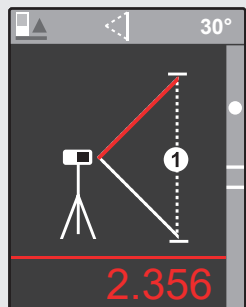

1

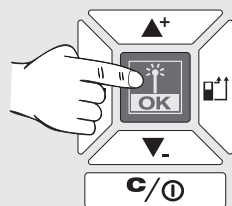

2

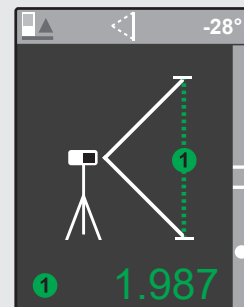
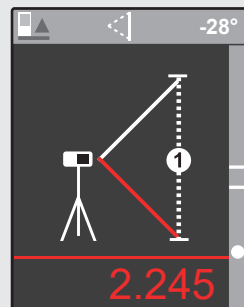
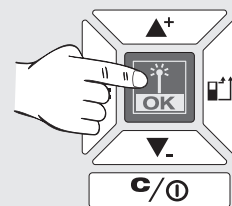

Brug et stativ eller en anden stabil overflade til at måle to forskellige længder.

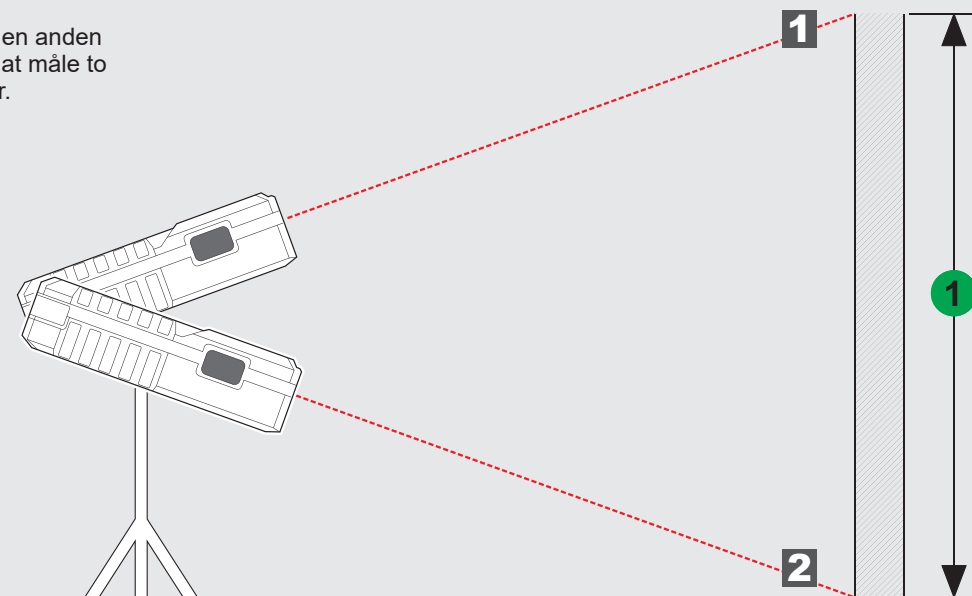

INNHold

Viktige sikkerhetsinstruksjoner	1
Tekniske data.....	2
Formålmessig bruk	2
Feilkode tabell	2
Oversikt	3
Målingspunkt	4
Meny	5
Start	6
Måling av lengde	7
Måling av flate	8
Måling av hele arealet	9
Måling av volum.....	10
Indirekte høyde-/Lengdemåling (bare med LDM 100).....	11
Indirekte høydemåling (bare med LDM 100).....	12

VIKTIGE SIKKERHETSINSTRUKSER



Ikke bruk produktet før du har studert sikkerhetsinstruksene og brukerhåndboken på vedlagte CD.

Laserklassifisering

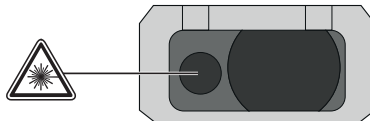

ADVARSEL:

Dette er et Class 2 laserprodukt i henhold til EN60825-1:2014



OBS:

Unngå direkte øye kontakt. Laserstrålen kan gi blitzer i øynene, noe som kan føre til en midlertidig blinding.

Unngå å inn i laserstrålen og å rette den unødig mot andre personer.

Ikke pek mot andre personer.

Advarsel:

Ikke bruk laser apparatet i nærheten av barn. Ikke tillat at barn benytter laser-apparatet.

OBS! En reflekterende overflate kan sende laserstrålen tilbake til bruker eller reflektere andre personen.

Hold kroppsdelene i sikker avstand til deler som beveger seg.

Gjennomfør regelmessig kontrollmålinger. Spesielt før, under og etter viktige målinger.

Se opp for feilmålinger hvis det er feil ved instrumentet, hvis det har falt i bakken, hvis det har vært utsatt for ikke tillatte belastninger, eller hvis det har blitt ombygd.

Advarsel: Bruk av styreelement, innstillinger eller gjennomføring av andre fremgangsmåter enn de som er fastlagt i håndboken kan føre til farlig strålebelastning.

Lasermåleapparatet har et begrenset bruksområde. (Se avsnitt Tekniske data). Forsøk på måling utenfor det minimale og maksimale område forårsaker unøyaktigheter. Bruk ved vanskelige betingelser som for varmt, for kaldt, svært sterkt sollys, regn, snø, tåke eller andre betingelser som innskrenker sikten, kan føre til unøyaktige målinger.

Dersom lasermåleapparatet blir brakt fra en varm omgivelse til en kald omgivelse (eller omvendt), må det ventes til apparatet har tilpasset seg den nye omgivelsestemperaturen.

Lasermåleapparatet skal alltid oppbevares i rom som beskytter apparatet mot rystelse, vibrasjoner og ekstreme temperaturer.

Lasermåleapparatet skal beskyttes mot støv, væte og høy luftfuktighet. Dette kan skade de indre delene og ha innflytelse på nøyaktigheten.

Ikke bruk aggressive rensedmidler eller løsemiddel. Skal rengjøres bare med en ren myk klut.

Unngå harde slag på og fall av lasermåleapparatet.

Nøyaktigheten av apparatet burde kontrolleres dersom det har falt ned eller har vært utsatt for andre mekaniske belastninger.

Nødvendige reparasjoner på dette laser-apparatet skal kun gjøres av autorisert fagpersonale.

Ikke bruk instrumentet i eksplosjonsfarlige områder eller i aggressive miljøer.

 Brukte batterier må ikke kastes i husholdningsavfallet. Vern om miljøet og send dem til oppsamlingsstasjoner som er beregnet til dette i henhold til nasjonale eller lokale forskrifter. Produktet må ikke kastes i husholdningsavfallet. Utstyret må kasseres på forsvarlig måte i samsvar med gjeldende nasjonale forskrifter. Følg nasjonale og landsspesifikke bestemmelser.



TEKNISKE DATA

	LDM 45	LDM 100
Optik	15 mm x 9 mm	18 mm
Måleomåde		
Minimum avstand	45 m (Toleranse: 45,1 m)	100 m (Toleranse: 101 m)
Maksimal avstand	0,05 m	0,05 m
Avstands måling		
Typisk toleranse (gjelder for 100 % måle refleksjon (hvit malt vegg), lav bakgrunnsbelysning, 25 °C)	± 2,0 mm (en ekstra margin på 0,1 mm/m bør det tas hensyn til)	± 2,0 mm (en ekstra margin på 0,1 mm/m bør det tas hensyn til)
Maksimal toleranse (gjelder for mål med mindre refleksjon, høy bakgrunnsbelysning eller temperaturer som nærmer seg den nedre/øvre verdi)	± 4,0 mm (en ekstra margin på 0,15 mm/m bør det tas hensyn til)	± 4,0 mm (en ekstra margin på 0,15 mm/m bør det tas hensyn til)
Minste visbare enhet	1,0 mm	1,0 mm
Laser punkt størrelse		
16 m avstand:	25 x 50 mm	25 x 50 mm
Laser klasse	2	2
Laser type	635 nm, < 1 mW	635 nm, < 1 mW
Laserstråle		
vertikalvinkel	+1 grad	+1 grad
horisontalvinkel	±1 grad	±1 grad
Display type	LCD (31,5 mm x 40 mm)	LCD (31,5 mm x 40 mm)
Automatisk avslåing av laser	90 sekund	90 sekund
Automatisk avslåing av apparatet	180 sekund	180 sekund
Strømforsyning	AAA 2x (Alkaline-batteri)	AAA 2x (Alkaline-batteri)
Batteriets levetid	8000 (Enkeltmåling)	8000 (Enkeltmåling)
Arbeidstemperaturområde	-0°C til +40°C	-0°C til +40°C
Lagertemperaturområdes	-10°C til +60°C	-10°C til +60°C
Vekt uten batteri	87 g	122 g
Verneklasse	IP54 (støv- og sprutevann beskyttet)	IP54 (støv- og sprutevann beskyttet)

FORMÅLSMESSIG BRUK

Lasermåleapparatet er egnet for måling av avstander og hellinger. Dette apparatet må kun brukes til de oppgitte formål.

FEILKODE TABELL

Kode	Beskrivelse	Løsning
Err500	Hardware problemer	Slå apparatet av og på igjen. Dersom problemet vedvarer så bring måleapparatet til neste servicesenter.

OVERSIKT

STATUSLINJE

- ▶ Referanse målepunkt, type måling, målingsvinkel (bare med LDM 100), målingsplan (bare med LDM 100)

DISPLAY

- ▶ Meny
- ▶ Målinger
- ▶ Innstillinger

OPPOVER / ADDERE

- ▶ Gå oppover i menyen
- ▶ Addere verdien

MÅLING / OK

- ▶ Slå på laser
- ▶ Lagre måleverdien
- ▶ Velg OK i menyen

MENY

- ▶ Historie
- ▶ Måling
- ▶ Innstilling

NEDOVER / SUBTRAHERE

- ▶ Gå nedover i menyen
- ▶ Subtrahere verdien

SLETTE / SLÅ PÅ / AV

- ▶ PÅ / AV (hold tasten trykt til apparatet sender en signaltone)
- ▶ Slette måleverdien

MÅLINGSPUNKT

- ▶ Bak (Standardinnstilling)
- ▶ Foran
- ▶ Hjørne (blir automatisk aktivert når stiften brettes ut.)

MÅLING

- ▶ Slå på laser
- ▶ Lagre måleverdien

SKIFT BATTERI

- ▶ Skift batteri når batterisymbolet blinker

1

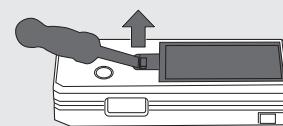

2

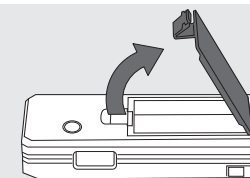

3

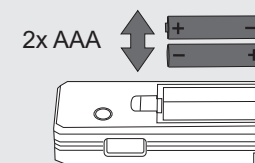

4

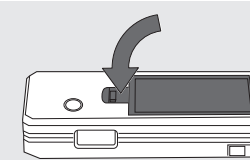

STATIV

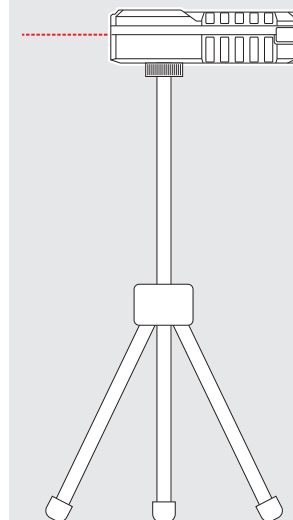

HJØRNESTIFT

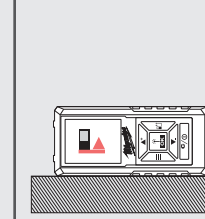
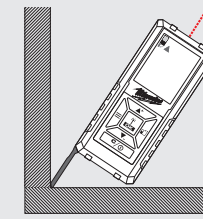

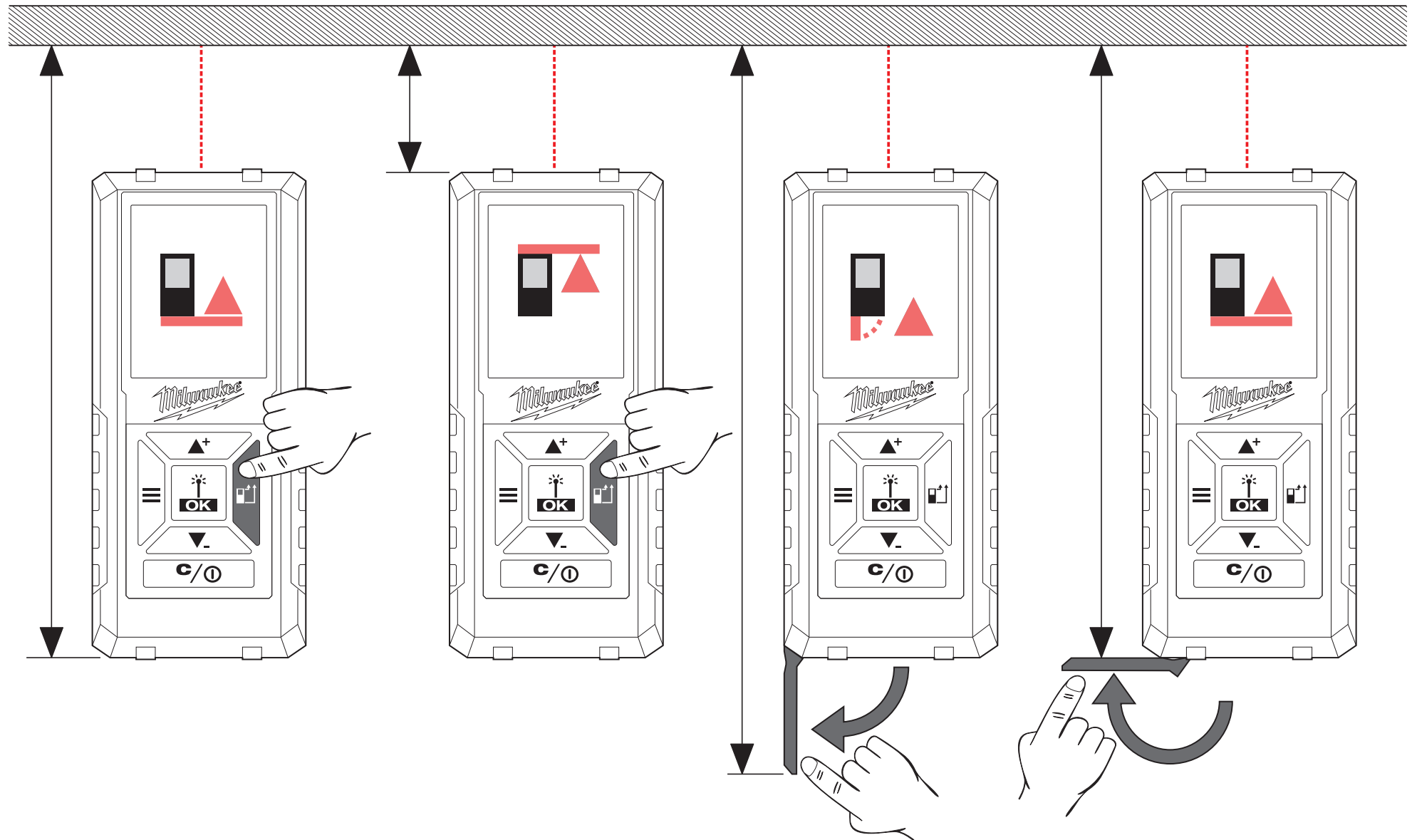

MENY

HISTORIE



Vising av de siste 30 målinger/beregninger.
De individuelle målinger av overflater, hele arealet, volum osv. blir ikke lagret i HISTORIE. Her blir bare resultatet av beregningene lagret.
For å slette en notering, trykk tast C/PÅ/AV.

Til verdiene i HISTORIE kan målinger/beregninger adderes eller subtraheres. Det kan bare utføres beregninger av samme type målinger (lengde, flate volum osv.)

For å utføre en beregning:

1. Bruk tasten ▲+ ▼ for å velge en målemodus i HISTORIE.
2. Trykk OK-tasten.
3. Gjennomfør målingene som er nødvendig for beregningen.
4. Trykk OK tasten for å lagre den nye beregningen i HISTORIE,

MÅLING

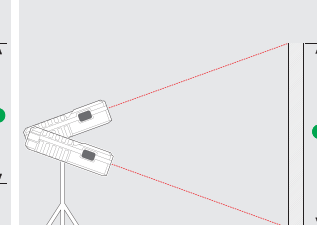
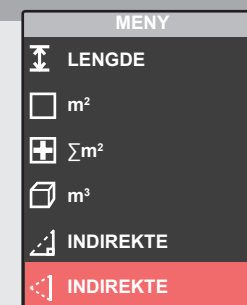
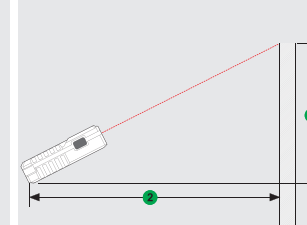
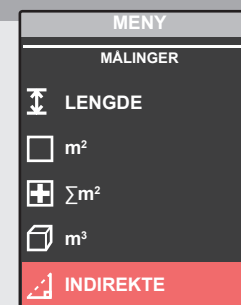
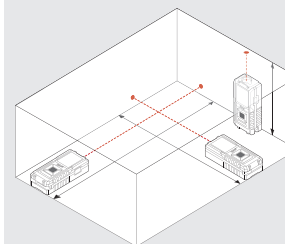
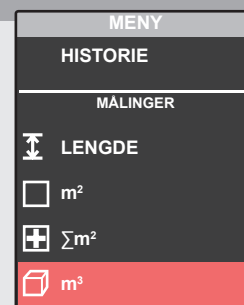
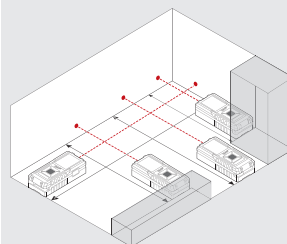
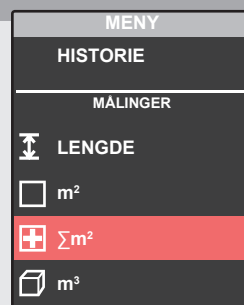
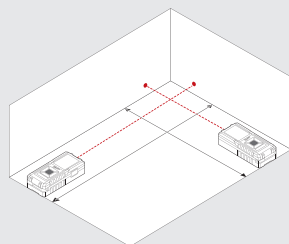
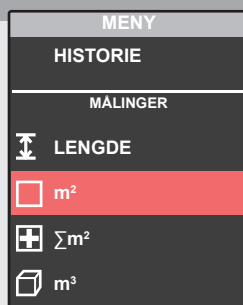
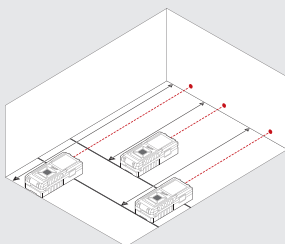
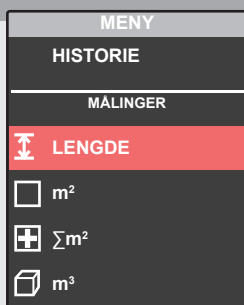

INNSTILLINGER

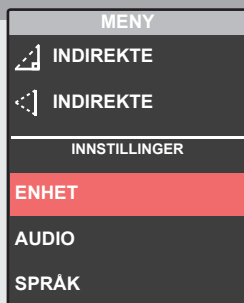

Velg den ønskede måleenheten.

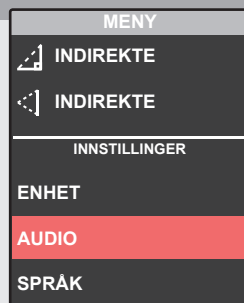

Signal tone på/av.



Velg språk.

START

1

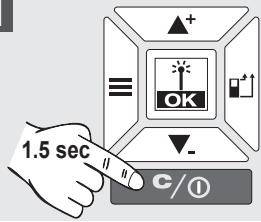

2

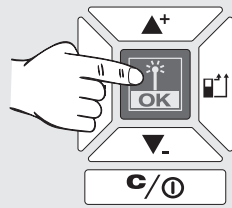

3

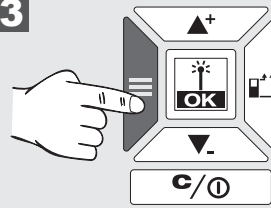

4

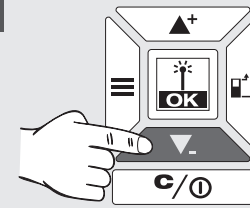

5

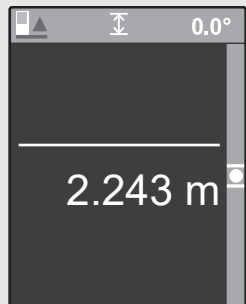
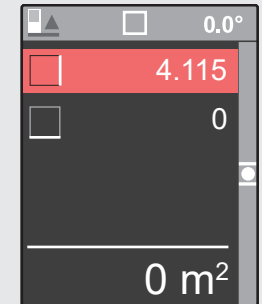
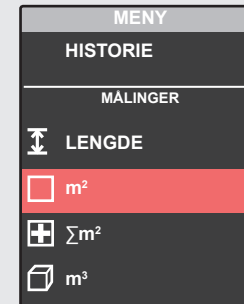
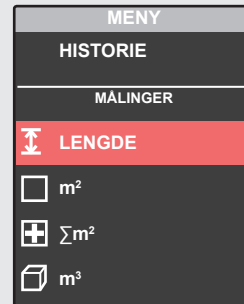
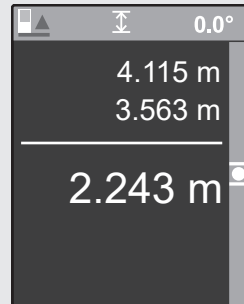
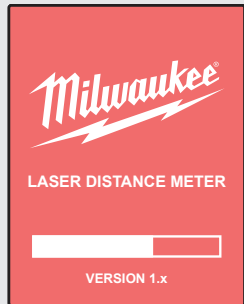
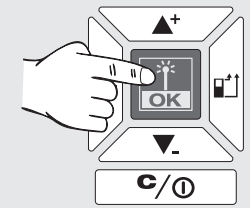

Etter det er slått på, blir automatisk LENGDE MÅLE MODUS aktivert.

Gjennomfør en LENGDEMÅLING eller ...

... Trykk meny-tasten for å skifte meny ...

... Og velg en annen driftstype ved hjelp av tasten ▲+ ▼- og

... Og aktiver denne driftstypen ved å trykke OK-tasten.

MÅLING AV LENGDE

0

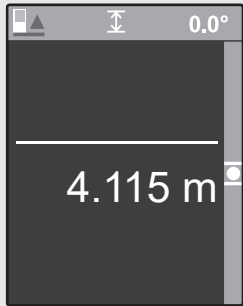

Måleverdi hvit = Verdi er målt

1

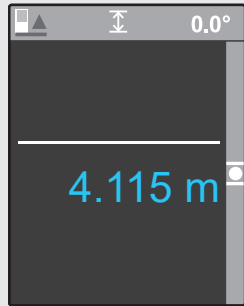
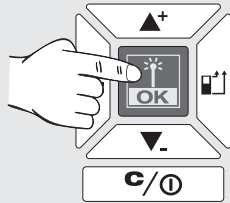

Måleverdi blå = Verdien er mellomlagret

2

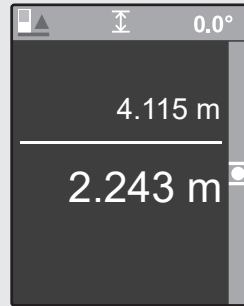
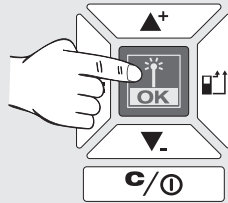

3

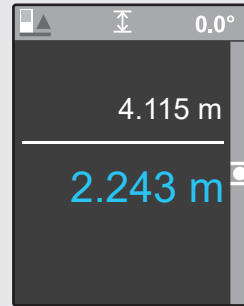
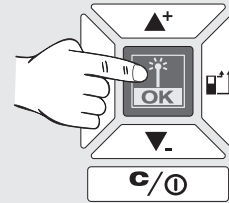

4

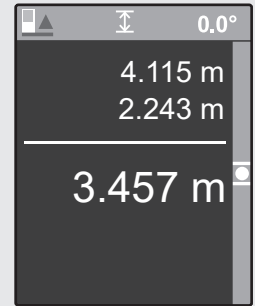
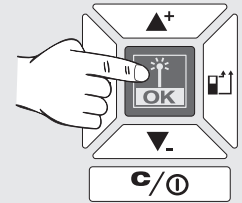

5

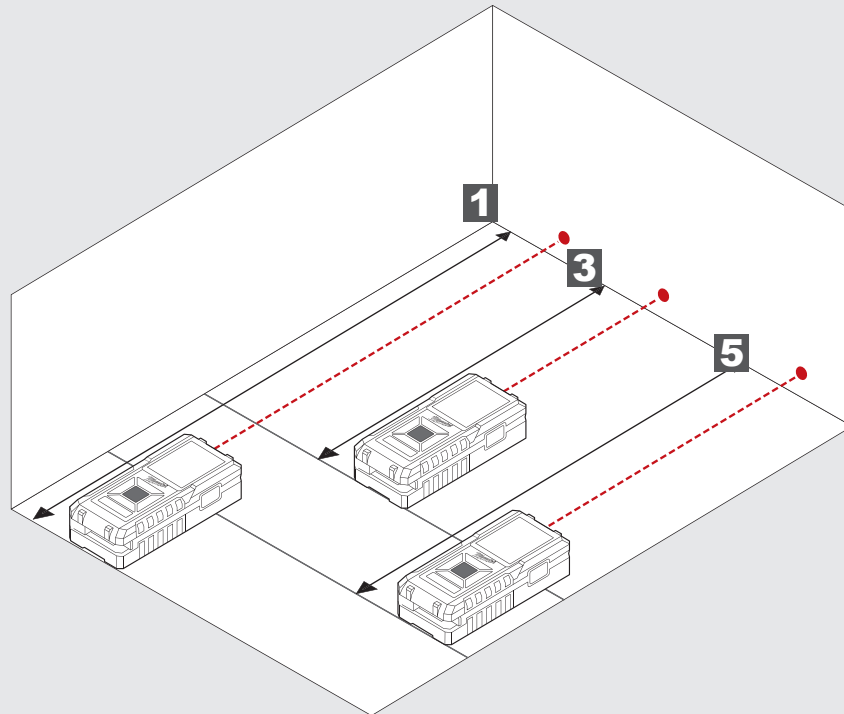
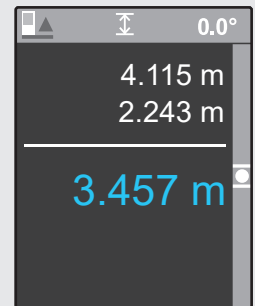
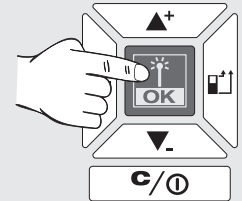

MÅLING AV FLATE

0

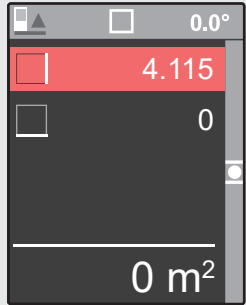

1

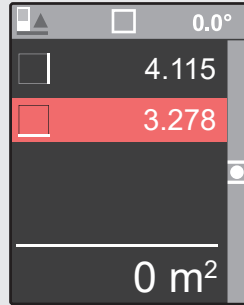
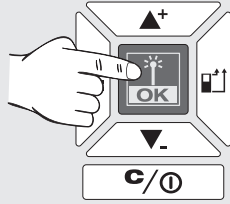

2

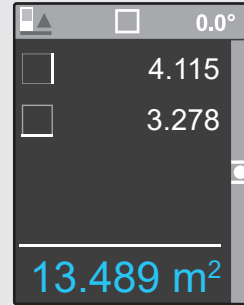
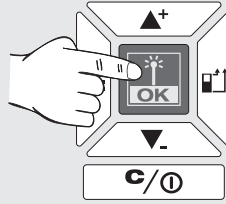

2

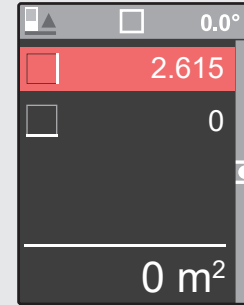
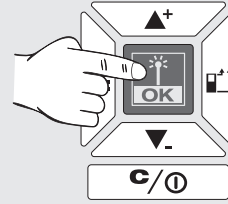

Ny måling.
Verdien blir lagret i HISTORIE

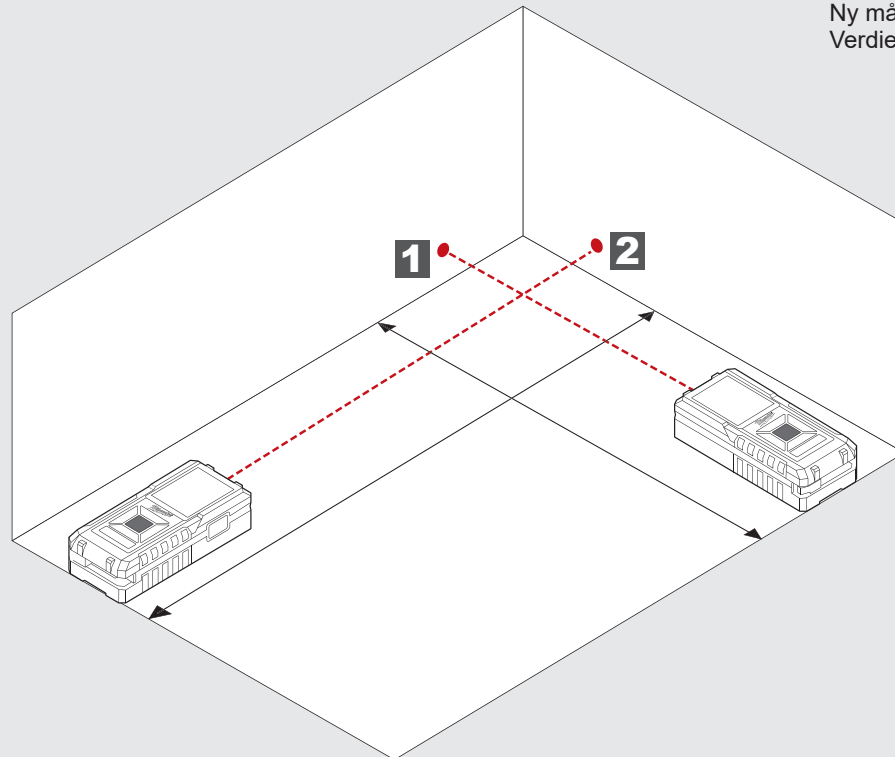

MÅLING AV HELE AREAET

0

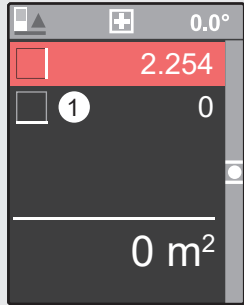

1

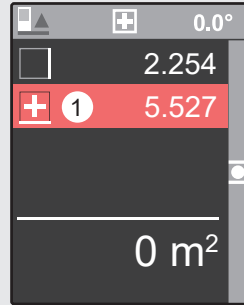
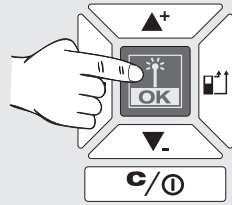

2

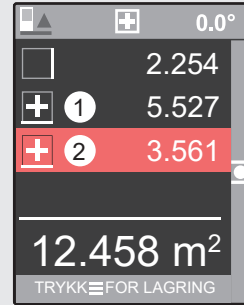
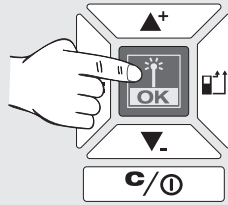

3

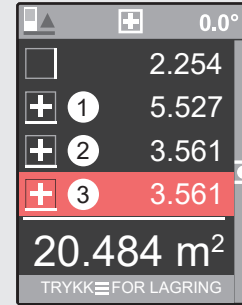
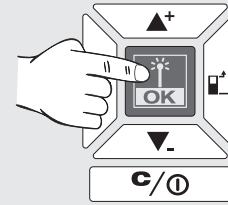

4

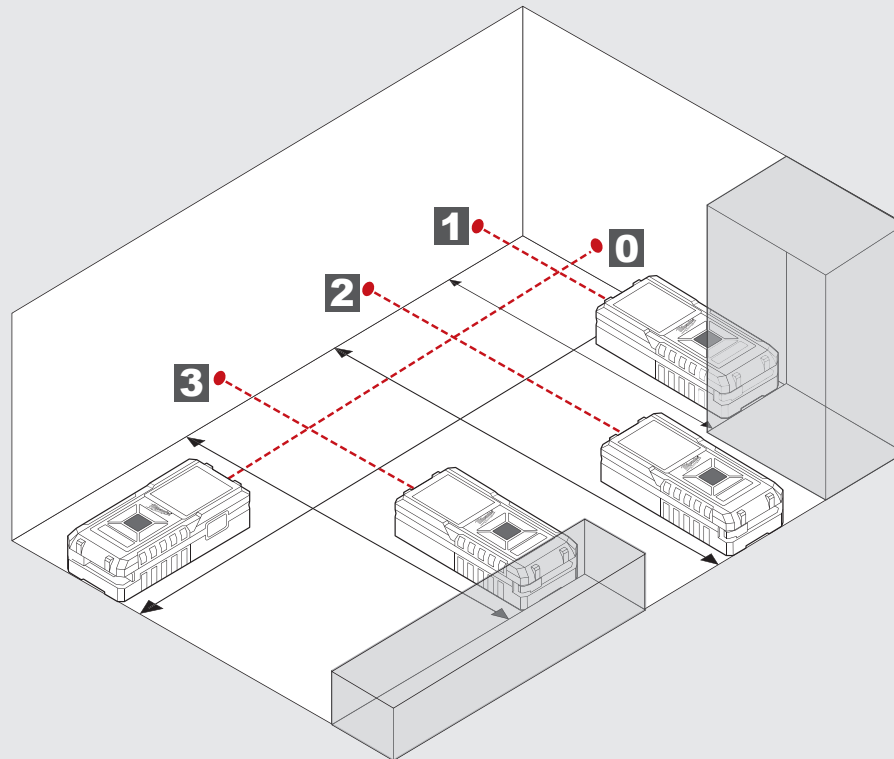
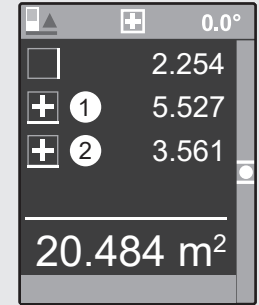
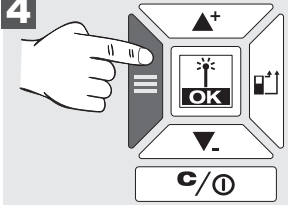

4

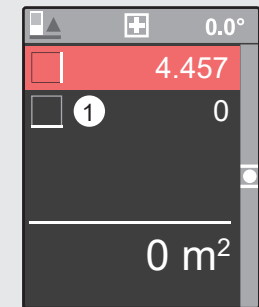
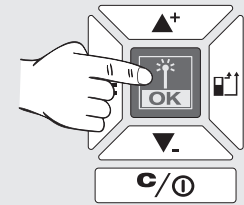

Ny måling.
Resultat blir lagret i HISTORIE

MÅLING AV VOLUM

0

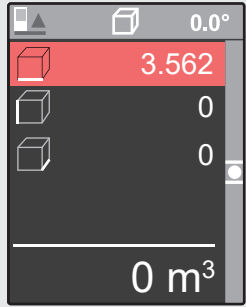

1

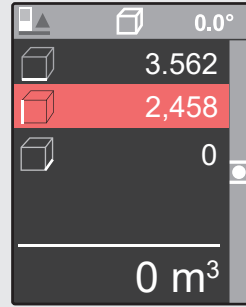
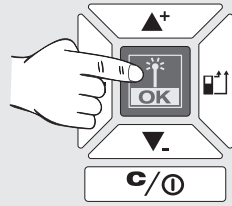

2

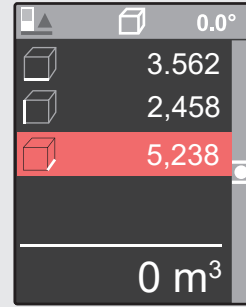
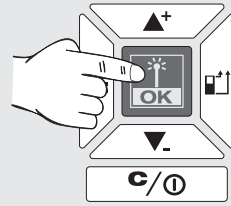

3

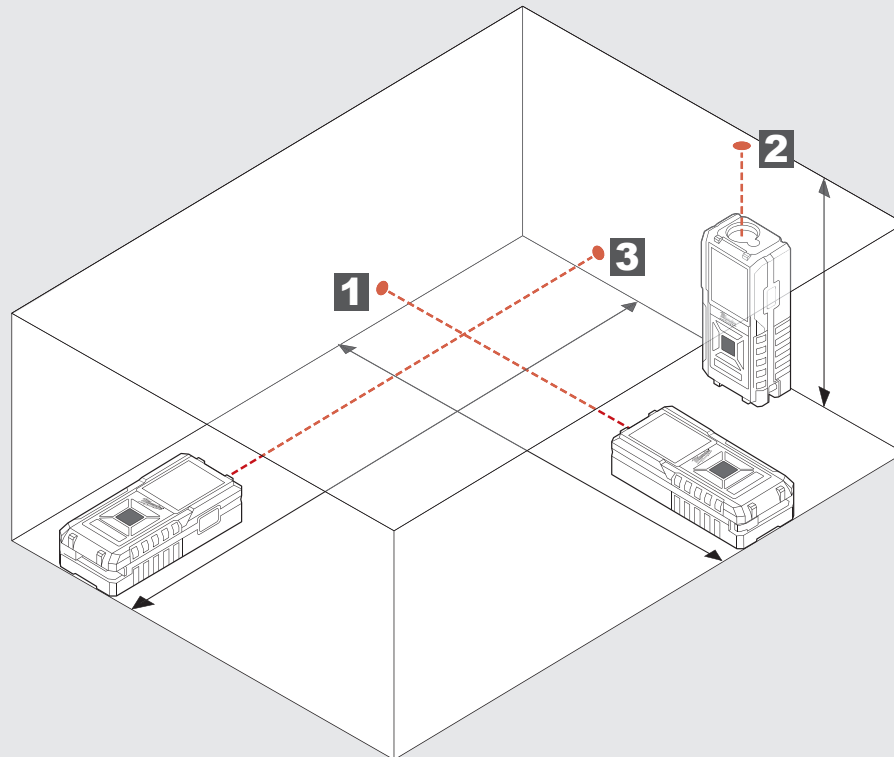
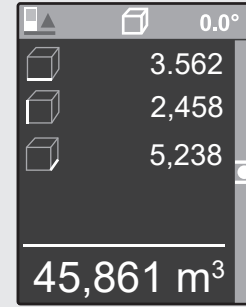
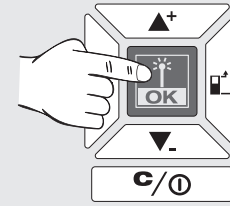

INDIREKTE HØYDE-/LENGDEMÅLING (BARE MED LDM 100)

0

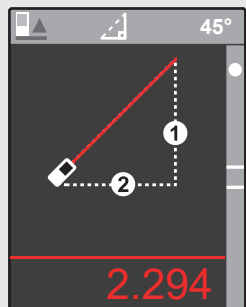

1

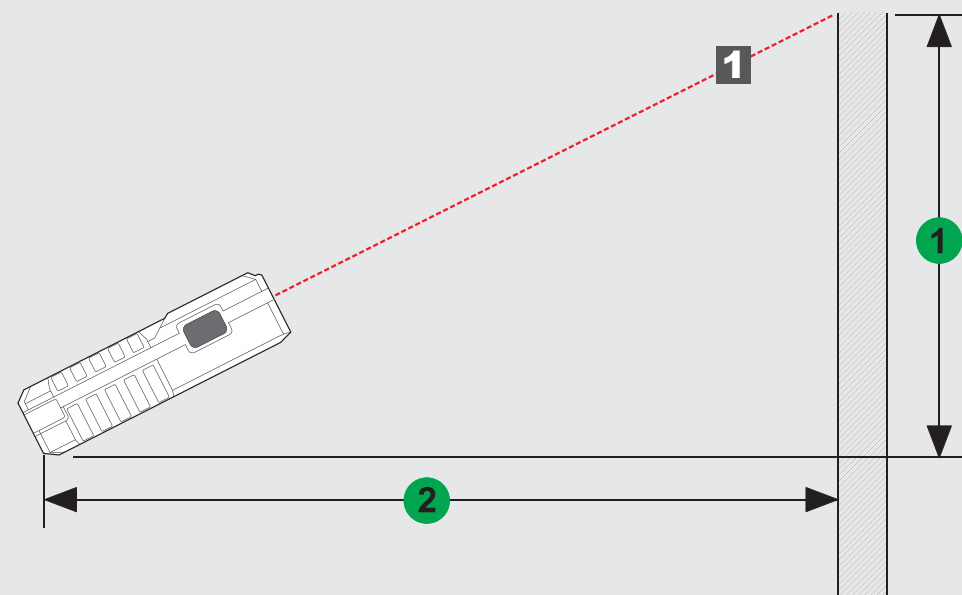
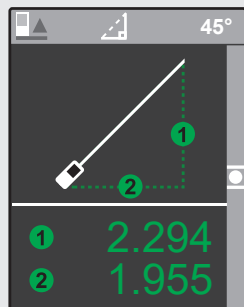
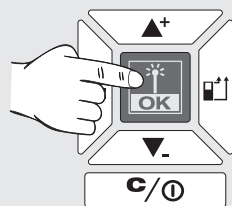

INDIREKTE HØYDEMÅLING (BARE MED LDM 100)

0

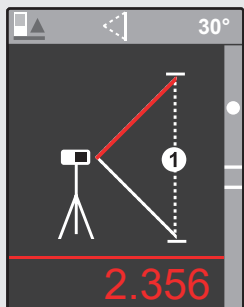

1

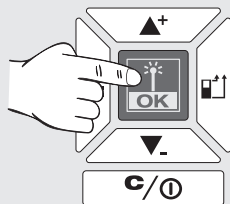

2

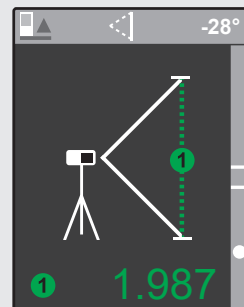
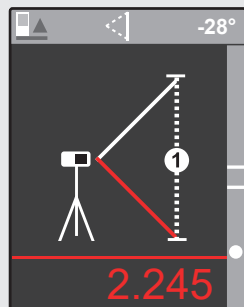
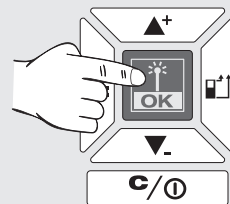

Bruk et stativ eller en annen stabil overflate for å måle to forskjellige lengder.

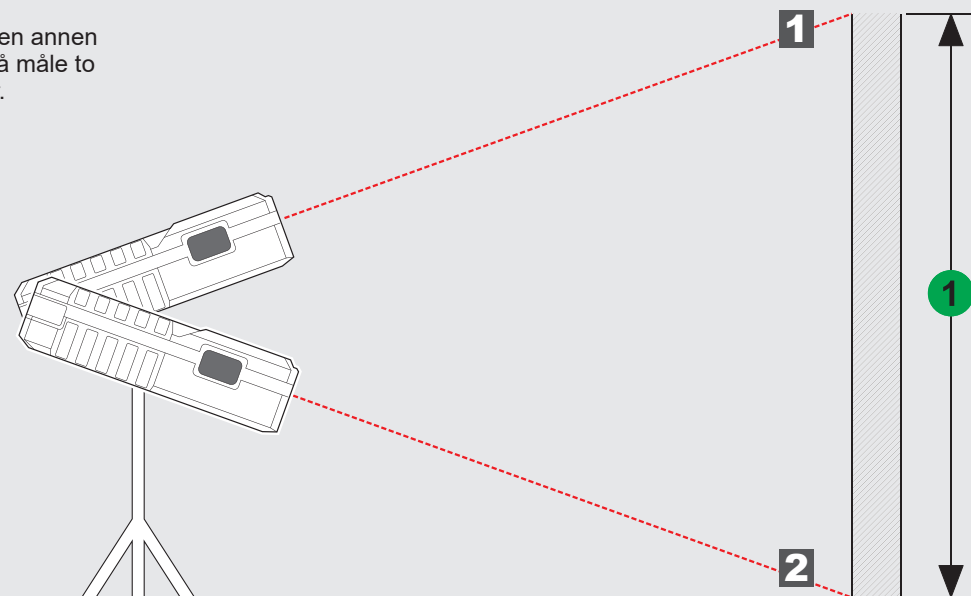

INNEHÅLL

Viktiga säkerhetsföreskrifter	1
Tekniska data.....	2
Använd maskinen enligt anvisningarna	2
Tabell med felkoder	2
Översikt	3
Mätpunkt.....	4
Meny.....	5
Starta	6
Längdmätning.....	7
Ytmätning	8
Mäta totalyta	9
Volymmätning	10
Indirekt höjd-/längdmätning (endast med LDM 100)	11
Indirekt höjdmätning (endast med LDM 100)	12

VIKTIGA SÄKERHETSFÖRESKRIFTER



Använd inte denna produkt utan att läsa säkerhetsföreskrifter och handbok på bifogad CD.

Laserklassificering

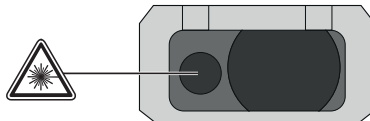

WARNING:

Produkten motsvarar klass 2 enligt: EN60825-1:2014



Varning:

Undvik direkt blickkontakt: Laserstrålen kan blixtra i ögonen och leda till en kortvarig bländning.

Titta inte in i laserstrålen och rikta den inte mot andra personer i onödan.

Blända inte andra personer.

Varning:

Använd laser-apparaten aldrig i närheten av barn och tillåt barn aldrig att använda laser-apparaten .

Varning! En reflekterande yta kan kasta tillbaka laserstrålen till användaren eller andra personer.

Håll fingrarna på säkert avstånd från roterande komponenter.

Utför periodiska kontrollmätningar. Särskilt före, under och efter viktiga mätningar.

Se upp för felaktiga mätningar om en defekt produkt används, efter ett fall eller andra otillåtna påfrestningar resp. förändringar av produkten.

Varning: Användning av manöverkomponenter och inställningar eller andra förfaranden resp. metoder som inte nämns i manualen kan orsaka farlig strålbekstrålning.

Lasermätinstrumentet har ett begränsat användningsområde. (Se avsnittet Tekniska data). Försök att göra mätningar utanför det maximala resp. det minimala området leder till bristande noggrannhet. Användning vid ogynnsamma förhållande som för kallt, för varmt, starkt solljus, regn, snö, dimma eller andra förhållanden som begränsar sikten kan leda till oprecisa mätningar.

Om lasermätinstrumentet förs från en varm omgivning till en kall omgivning (eller tvärt om), vänta tills instrumentet har anpassat sig till den nya omgivningstemperaturen.

Förvara alltid lasermätinstrumentet i utrymmen som skyddar instrumentet mot skakningar, vibrationer eller extrema temperaturer.

Skydda lasermätinstrumentet mot damm, fukt och hög luftfuktighet. Detta kan förstöra komponenter inne i instrumentet på påverka noggrannheten.

Använd inga aggressiva rengöringsmedel eller lösningsmedel. Rengör endast med en ren, fuktig trasa.

Undvik kraftiga slag mot instrumentet och låt det inte falla till marken. Instrumentets noggrannhet bör kontrolleras om det har fallit till marken eller har utsatts för andra mekaniska belastningar.

Om denna laser-apparat behöver repareras så får endast auktoriserad fackpersonal utföra reparationen.

Använd inte produkten i aggressiv eller explosiv miljö.

 Tomma batterier får inte avfallshandteras som hushållssopor. Tänk på miljön och lämna in batterierna till närmaste återvinningsstation enligt gällande miljölagstiftning. Instrumentet får inte avfallshandteras

som hushållssopor. Se till att instrumentet skrotas på ett ådant sätt att nationella regler efterlevs. Följ nationella och landsspecifika regler. Kontakta de lokala myndigheterna eller återförsäljaren om du har frågor som gäller avfallshanderingen.

 CE-symbol

TEKNISKA DATA

	LDM 45	LDM 100
Optik	15 mm x 9 mm	18 mm
Mätområde		
Minimalt avstånd	45 m (Tolerans: 45,1 m)	100 m (Tolerans: 101 m)
Maximalt avstånd	0,05 m	0,05 m
Avståndsmätning		
Typisk tolerans (gäller för 100 % målreflektion (vit lackerad vägg), låg bakgrundsbelysning, 25 °C)	± 2,0 mm (en ytterligare tolerans på 0,1 mm/m bör beaktas)	± 2,0 mm (en ytterligare tolerans på 0,1 mm/m bör beaktas)
Maximal tolerans (gäller för mål med lägre reflektion, hög bakgrundsbelysning eller temperaturer som närmar sig det nedre/övre värdet)	± 4,0 mm (en ytterligare tolerans på 0,15 mm/m bör beaktas)	± 4,0 mm (en ytterligare tolerans på 0,15 mm/m bör beaktas)
Minsta enhet som kan visas	1,0 mm	1,0 mm
Laserpunktstorlek		
16 m avstånd:	25 x 50 mm	25 x 50 mm
Laserklass	2	2
Lasertyp	635 nm, < 1 mW	635 nm, < 1 mW
Laserstråle		
vertikalvinkel	+1 grad	+1 grad
horisontalvinkel	±1 grad	±1 grad
Displaytyp	LCD (31,5 mm x 40 mm)	LCD (31,5 mm x 40 mm)
Automatisk laseravstängning	90 sekunder	90 sekunder
Automatisk apparatavstängning	180 sekunder	180 sekunder
Strömförsörjning	AAA 2x (alkali-batteri)	AAA 2x (alkali-batteri)
Batteriets livstid	8000 (enskild mätning)	8000 (enskild mätning)
Arbetstemperaturområde	-0°C till +40°C	-0°C till +40°C
Lagertemperaturområde	-10°C till +60°C	-10°C till +60°C
Vikt utan batteri	87 g	122 g
Skyddsklass	IP54 (damm- och stänkvattenskydd)	IP54 (damm- och stänkvattenskydd)

ANVÄND MASKINEN ENLIGT ANVISNINGARNA

Lasermätinstrumentet är avsett att användas för mätning av avstånd och lutningar. Maskinen får endast användas för angiven tillämpning.

TABELL MED FELKODER

Kod	Beskrivning	Lösning
Err500	Hårdvaruproblem	Stäng av mätinstrumentet och slå på det igen. Om problemet kvarstår, ta mätinstrumentet till närmaste service center.

ÖVERSIKT

STATUSRAD

- ▶ Referensmätupunkt, typ av mätning, mätvinkel (endast med LDM 100), mätnivåer (endast med LDM 100)

DISPLAY

- ▶ Meny
- ▶ Mätningar
- ▶ Inställningar

UPP/ADDERA

- ▶ Gå uppåt i menyn
- ▶ Addera värde

MÄTNING/OK

- ▶ Starta laser
- ▶ Spara mätvärde
- ▶ Välja OK i menyn

MENY

- ▶ Historik
- ▶ Mätning
- ▶ Inställningar

NEDÅT/SUBTRAHERA

- ▶ Gå nedåt i menyn
- ▶ Subtrahera värde

RADERA/STÄNGA AV/SLÅ PÅ APPARATEN

- ▶ PÅ/AV (håll knappen intryckt tills apparaten avger en signalton)
- ▶ Radera mätvärde

MÄTPUNKT

- ▶ Baktill (standardinställning)
- ▶ Framtill
- ▶ Hörn (aktiveras automatiskt genom att stiftet fälls ut)

MÄTA

- ▶ Starta laser
- ▶ Spara mätvärde

BYTA BATTERIER

- ▶ Byt batterier när battersymbolen blinkar.

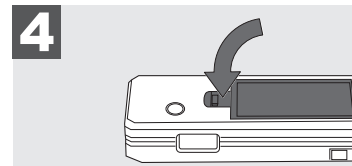
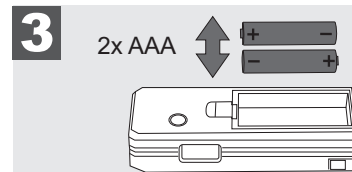
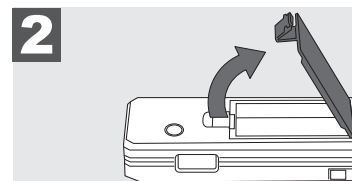
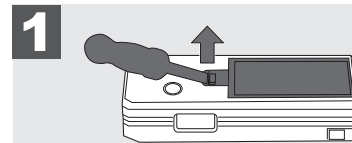

STATIV

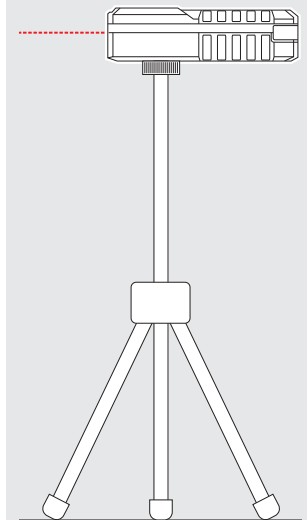

HÖRNSTIFT

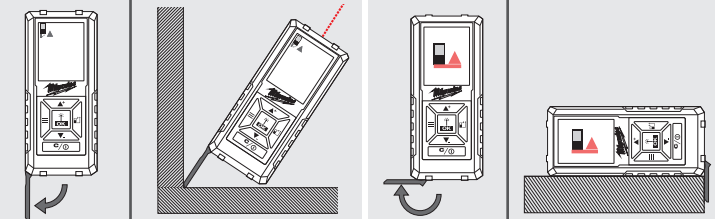

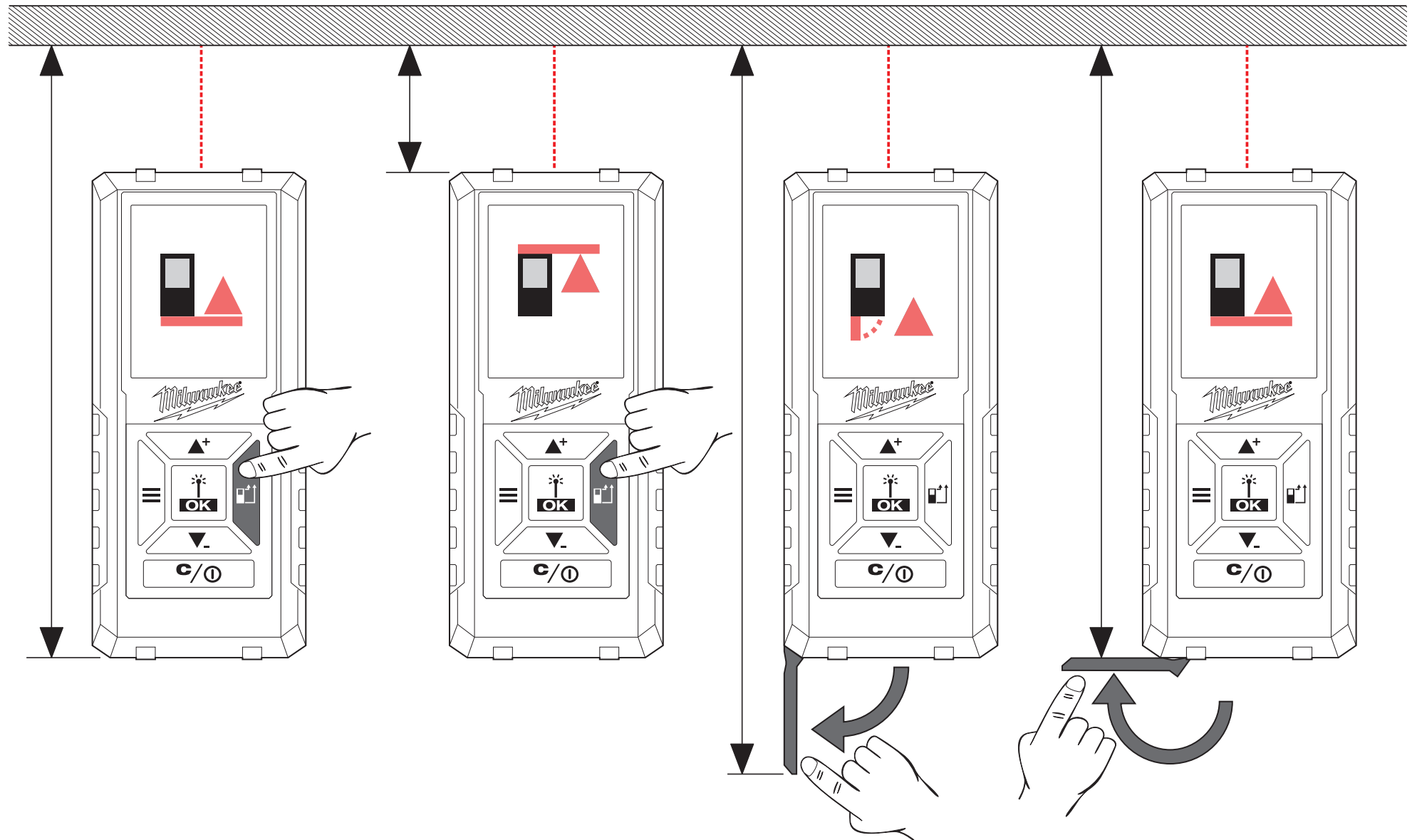

MENY

HISTORIK

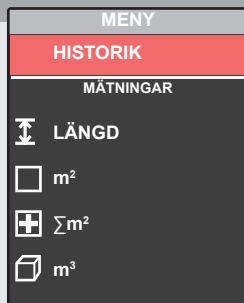

Visning av de senaste 30 mätningarna/beräkningarna.

De enskilda mätningarna för beräkning av yta, totalyta, volym m.m. sparas inte under HISTORIK utan bara resultatet av beräkningarna.

För att radera en post, tryck på knappen C/PÅ/AV.

Mätningar/beräkningar kan adderas till eller subtraheras från de värden som är sparade under HISTORIK. Endast beräkningar av samma typ (längd, yta, volym m.m.) kan utföras.

Utföra en beräkning:

1. Använd knapparna ▲+ ▼- för att välja en mätning från HISTORIK.
2. Tryck på OK knappen.
3. Utför de mätningar som krävs för beräkningen.
4. Tryck på knappen OK för att spara den nya beräkningen i HISTORIK.

MÄTNING

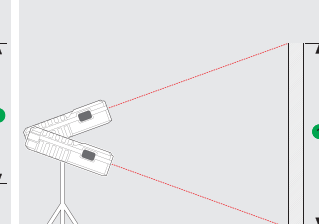
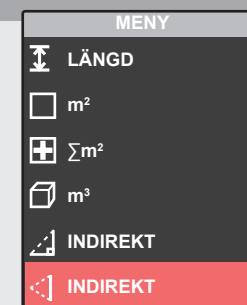
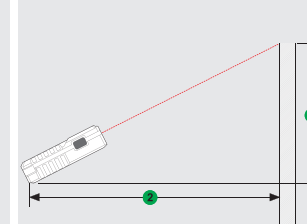
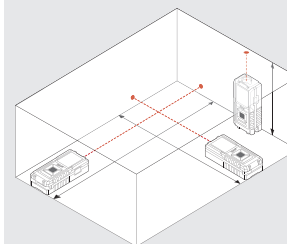
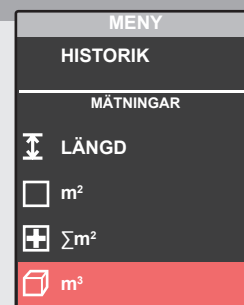
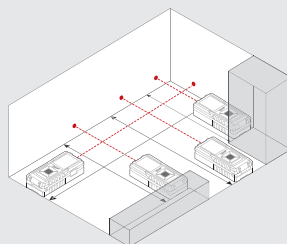
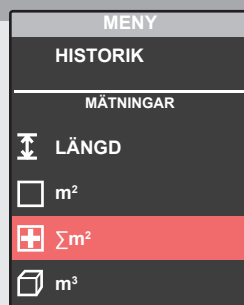
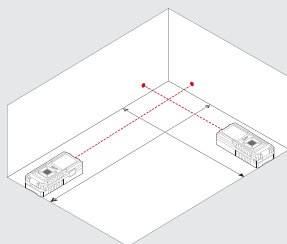
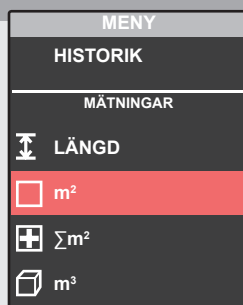
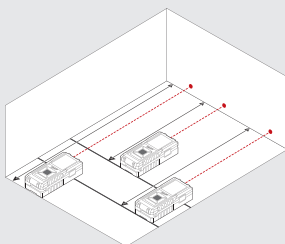
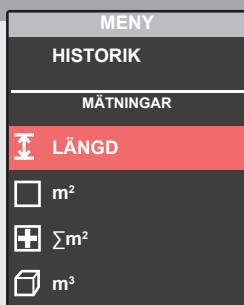

INSTÄLLNINGAR

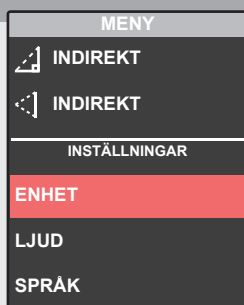

Välj önskad mätenhet.

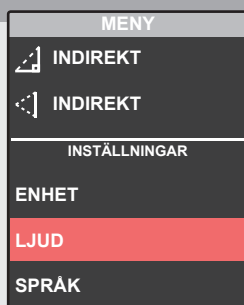

Signalton på/av.

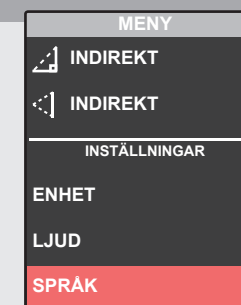

Välja språk.

STARTA

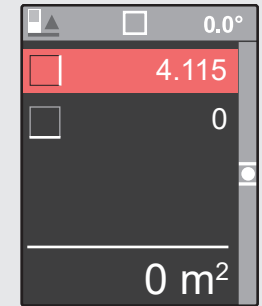
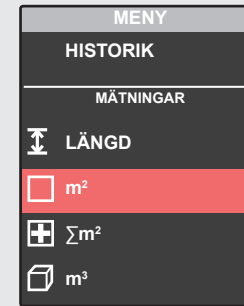
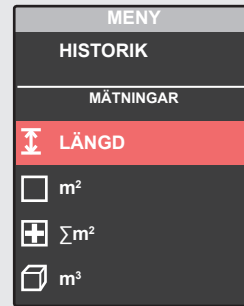
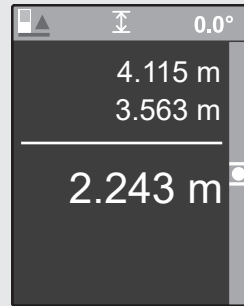
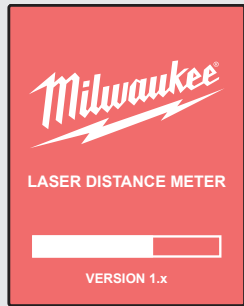
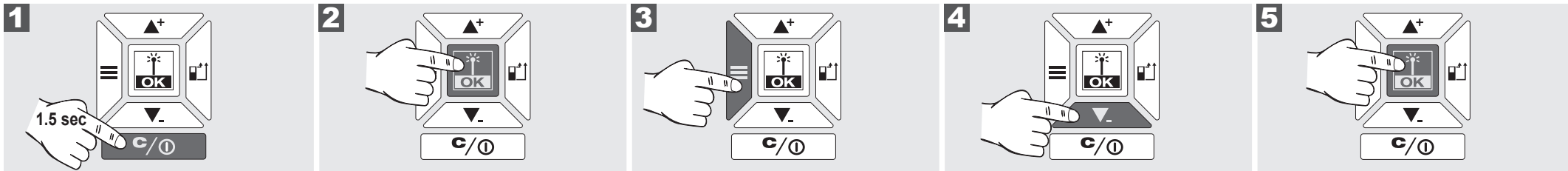

Efter påslagning aktiveras automatiskt LÄNGDMÄTNING.

Utför en LÄNGDMÄTNING eller ...

... tryck på menyknappen för att gå till menyn ...

... och välj ett annat läge med hjälp av knapparna ▲+ ▼- och ...

... och aktivera detta läge genom att trycka på knappen OK.

LÄNGDMÄTNING

0

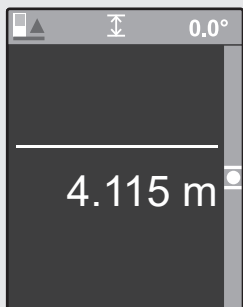

Mätvärde vitt = värdet har mätts

1

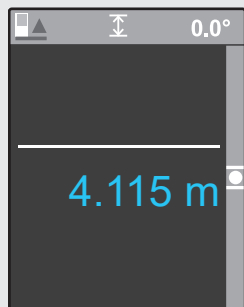
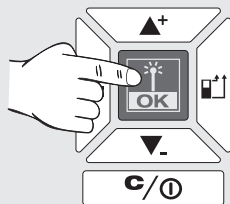

Mätvärde blått = värdet har frysts

2

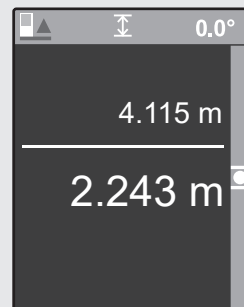
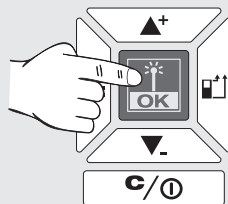

3

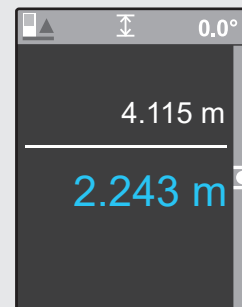
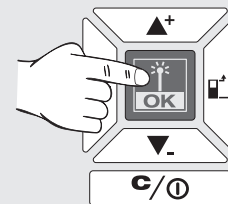

4

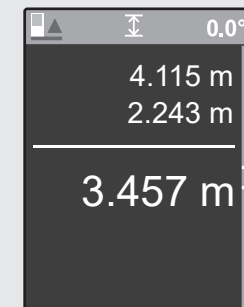
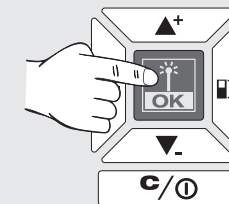

5

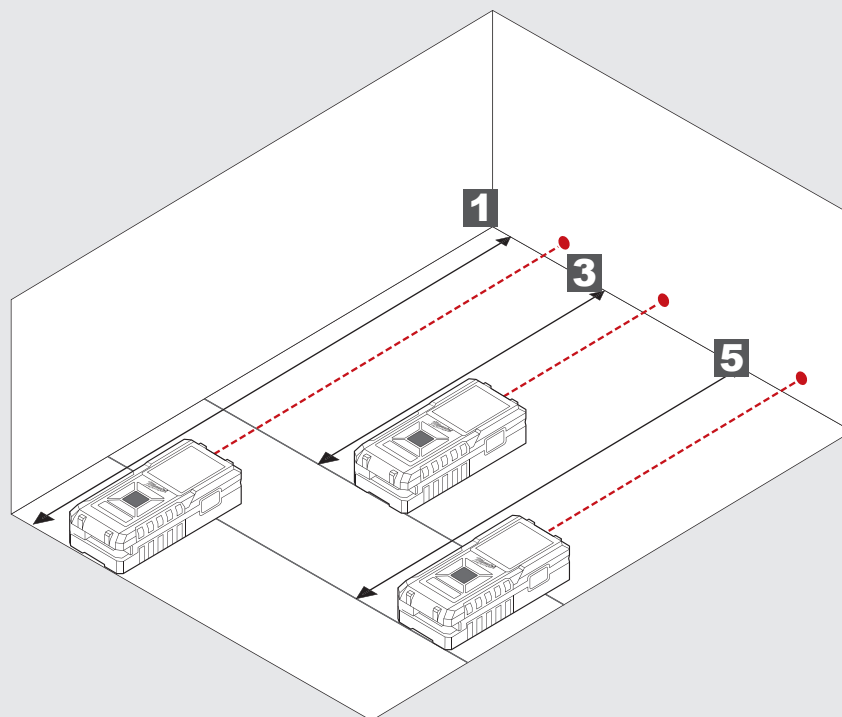
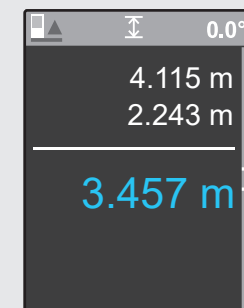
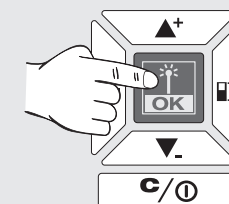

0

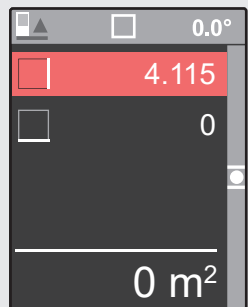

1

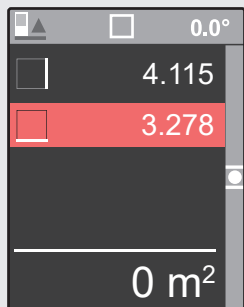
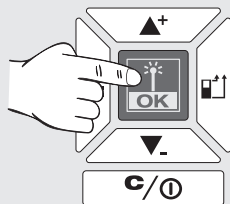

2

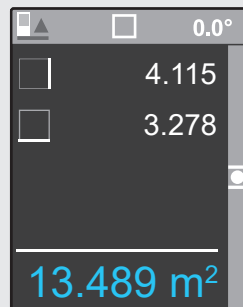
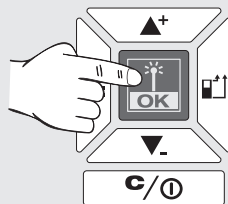

2

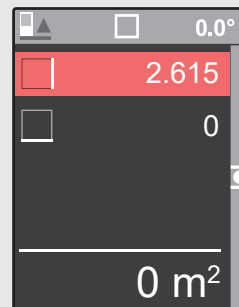
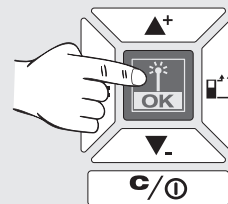

Ny mätning.
Värdet sparas under HISTORIK.

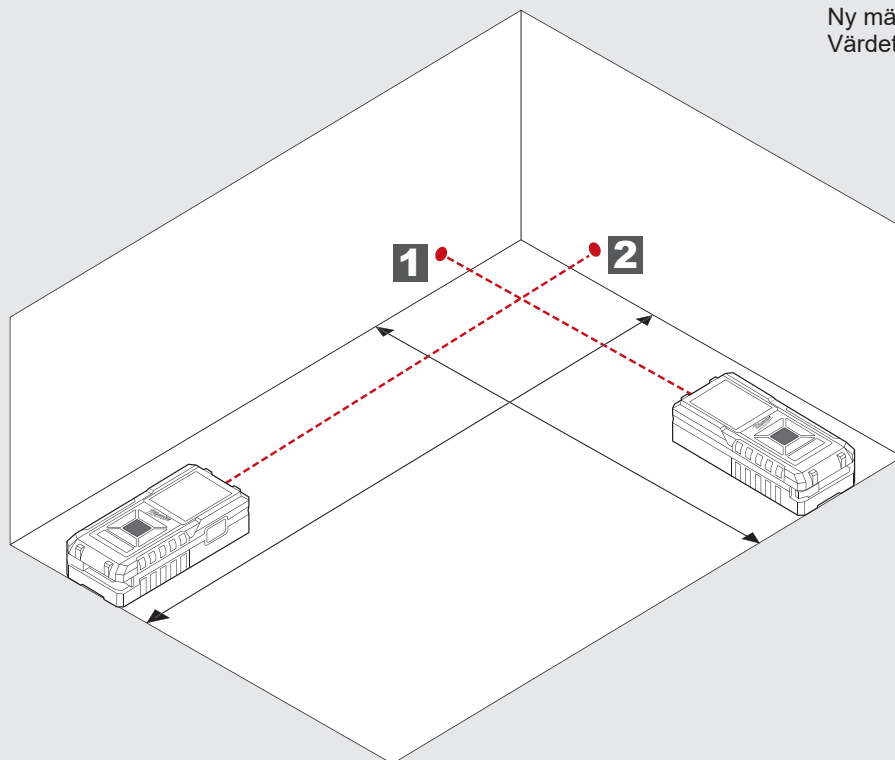

MÄTA TOTALYTA

0

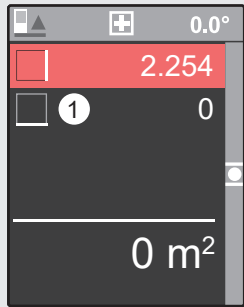

1

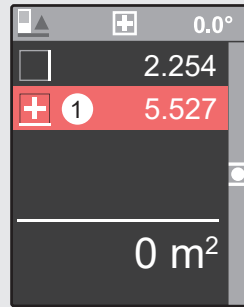
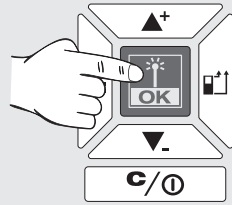

2

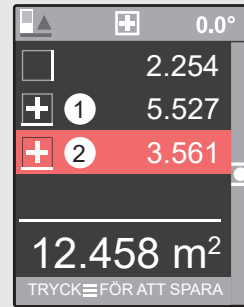
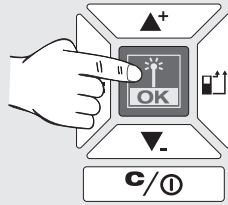

3

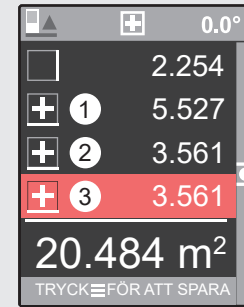
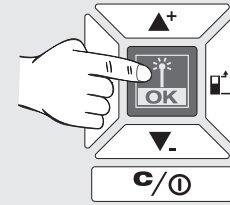

4

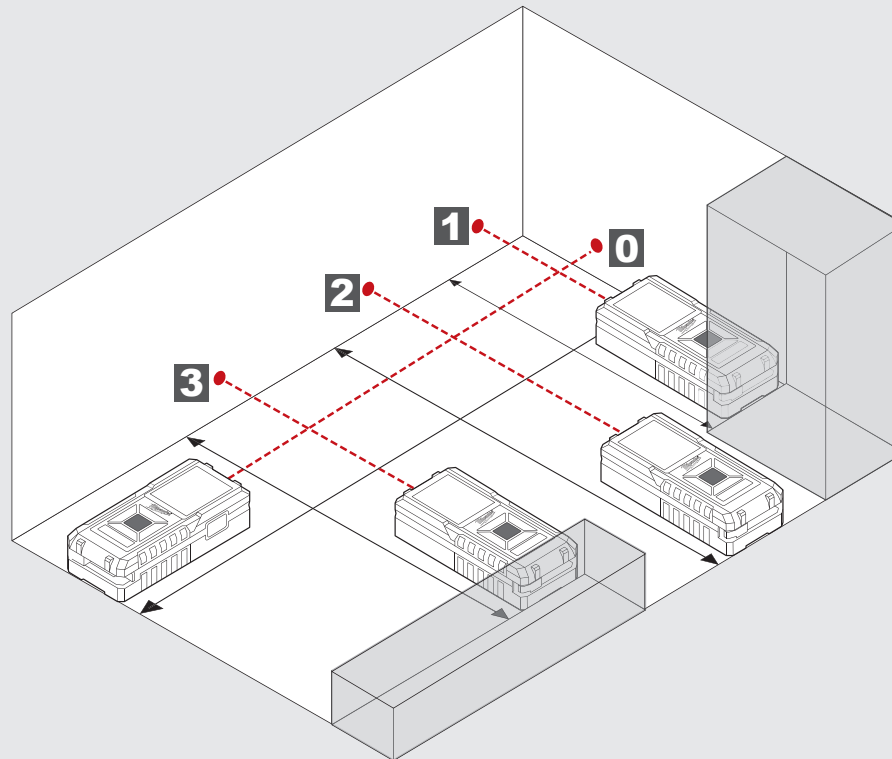
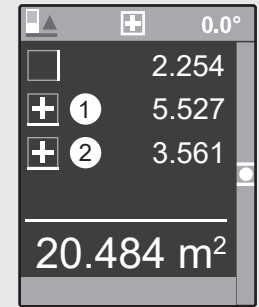
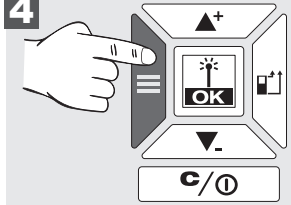

4

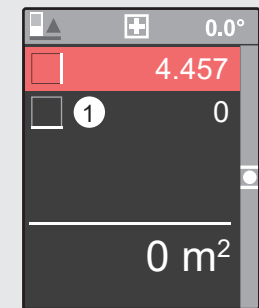
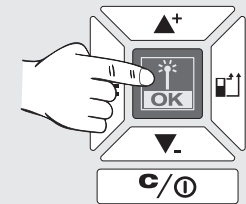

Ny mätning.
Resultatet sparas under HISTORIK.

VOLYMMÄTNING

0

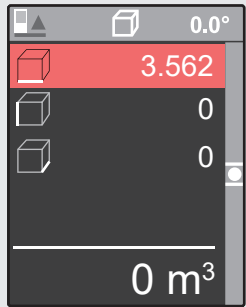

1

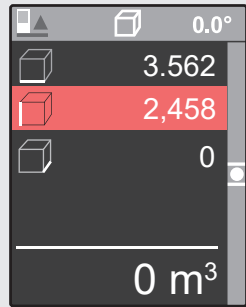
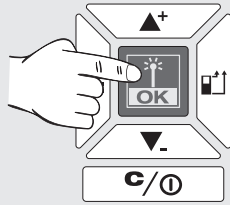

2

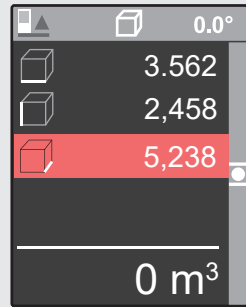
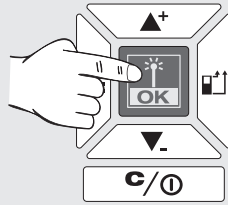

3

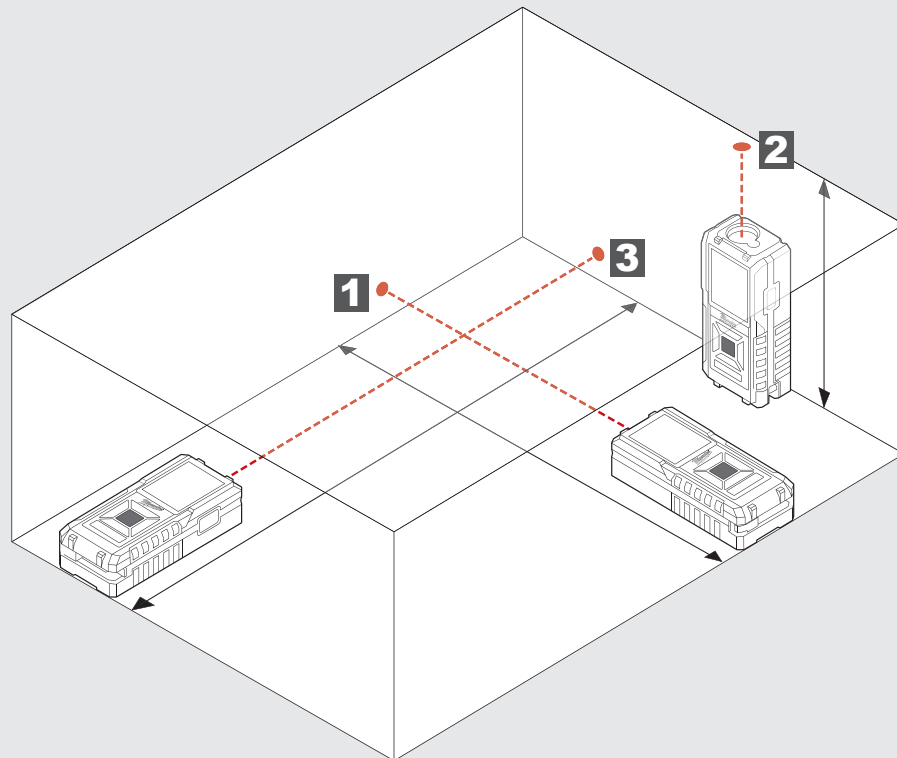
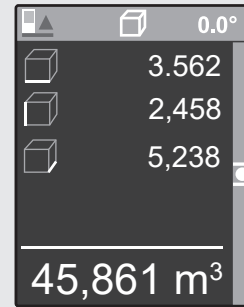
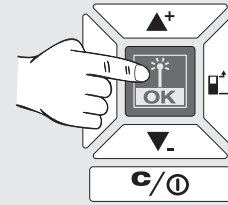

INDIREKT HÖJD-/LÄNGDMÄTNING (ENDAST MED LDM 100)

0

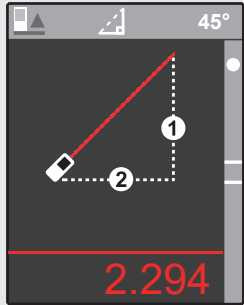

1

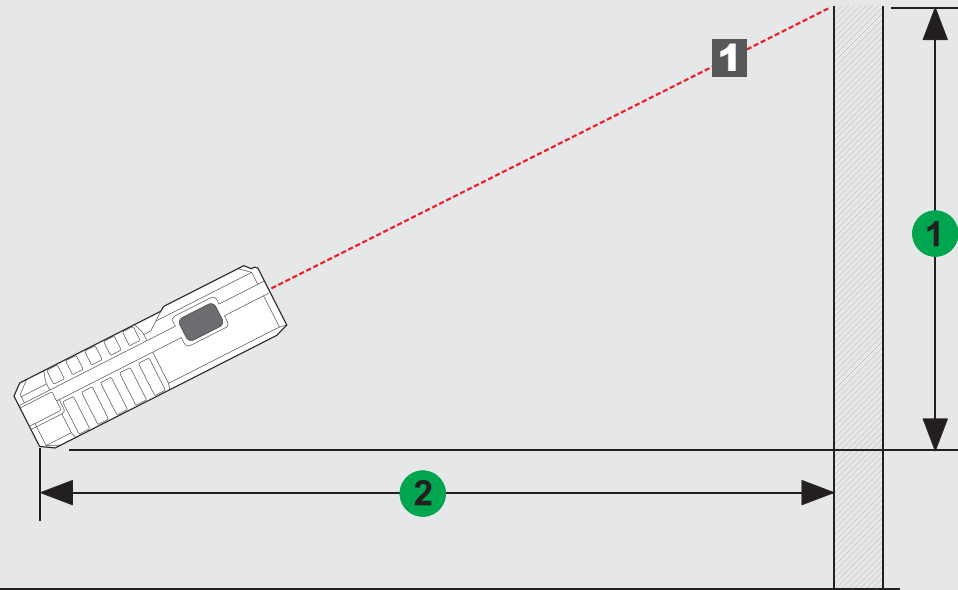
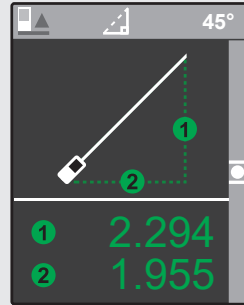
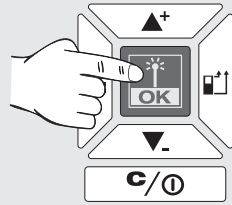

INDIREKT HÖJDMÄTNING (ENDAST MED LDM 100)

0

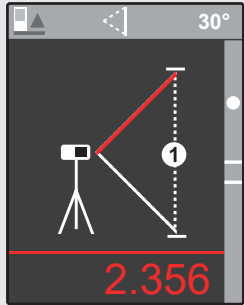

1

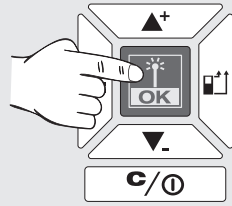

2

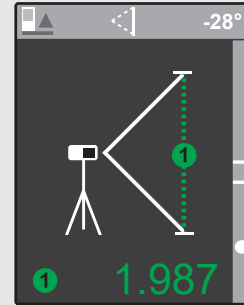
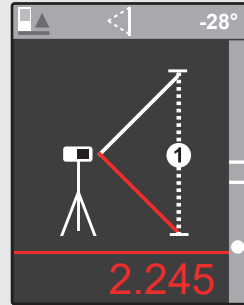
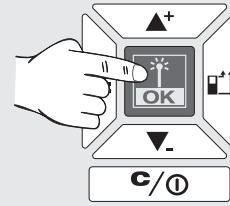

Använd ett stativ eller en annan stabil yta för att mäta två olika längder.

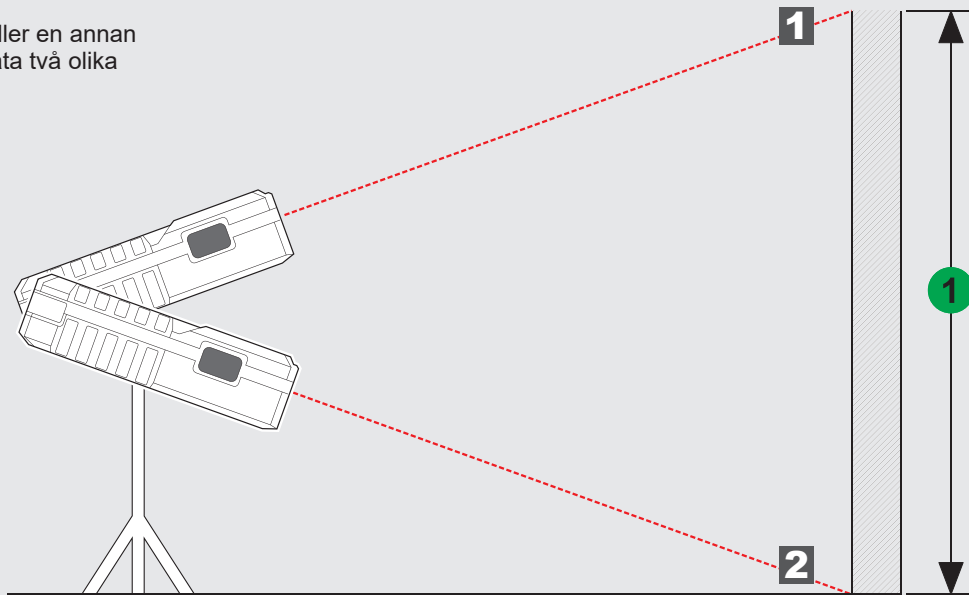

SISÄLTÖ

Tärkeitä turvallisuusohjeita	1
Tekniset arvot	2
Tarkoituksenmukainen käyttö	2
Virhekooditaulukko	2
Yhteenveto	3
Mittauspiste	4
Valikko	5
Aloittaminen	6
Pituuden mittaaminen	7
Pinta-alan mittaaminen	8
Kokonaispinta-alan mittaaminen	9
Tilavuuden mittaaminen	10
Epäsuora korkeuden / pituuden mittaaminen (vain LDM 100)	11
Epäsuora korkeuden mittaaminen (vain LDM 100)	12

TÄRKEITÄ TURVALLISUUSOHJEITA



Älä käytä tuotetta ennen kuin olet tutkinut Turvallisuusohjeet ja Käyttäjän käsikirjan oheiselta CD-levyltä.

Laserluokka

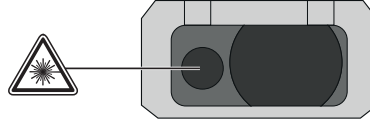

VAROITUS:

Se on Luokan 2 laser-tuote normin EN60825-1:2014 .



Varoitus:

Vältä katsomasta suoraan laseriin. Lasersäde saattaa häikäistä silmät salaman tavoin ja aiheuttaa ohimenevän sokaistumisen.

Älä katso suoraan lasersäteeseen, äläkä suuntaa sitä tarpeettomasti kohti muita ihmisiä.

Älä tähtää muihin henkilöihin.

Varoitus:

Älä käytä laserlaitetta lasten lähettyvillä äläkä anna lasten käyttää laserlaitetta.

Huomio! Heijastava pinta saattaisi heijastaa lasersäteen takaisin käyttäjään tai muihin henkilöihin.

Pidä raajat turvallisen matkan päässä liikkuvista osista.

Suorita säännöllisesti koemittauksia. Erityisesti ennen, aikana ja tärkeiden mittausten jälkeen.

Tarkkaile virheellisiä mittauksia, jos tuote on vial- linen, tai se on pudonnut, tai sitä on väärinkäytetty tai muutettu.

Varoitus: Ohjauslaitteiden, säätöjen tai muiden kuin käsikirjassa määritettyjen prosessien suorittaminen voi altistaa vaaralliselle säteilylle.

Lasermittarin käyttöalue on rajoitettu. (Katso kohtaa Tekniset tiedot). Jos yrität mitata pienimmän tai suurimman alueen ulkopuolelta, niin tulokset ovat epätarkkoja. Jos laitetta käytetään vaikeissa olosuhteissa, kuten liian kuumassa, liian kylmässä, hyvin kirkkaassa auringonvalossa, sateessa, lumisateessa, sumussa tai muissa näkyvyyttä rajoittavissa olosuhteissa, niin mittaustulokset voivat olla epätarkkoja.

Kun tuot lasermittarin lämpimästä tilasta kylmään tilaan (tai päinvastoin), odota, kunnes laite on sopeutunut ympäristön muuttuneeseen lämpötilaan.

Säilytä lasermittaria aina sisätiloissa ja suojaa laitetta iskuilta, tärinältä tai äärimmäisiltä lämpötiloilta.

Suojaa lasermittaria pölyltä, kosteudelta ja suurelta ilmakesteydeltä. Se saattaa tuhota laitteen sisäiset osat tai vaikuttaa sen tarkkuuteen.

Älä käytä mitään syövyttäviä puhdistusaineita tai liuotteita. Puhdista laite vain puhtaalla, pehmeällä rievulla.

Vältä lasermittariin kohdistuvia iskuja tai sen putoamista. Laitteen tarkkuus tulee tarkastaa, jos se on pudonnut tai siihen on kohdistunut muunlaista mekaanista rasitusta.

Vain valtuutettu ammattihenkilöstö saa suorittaa tämän laserlaitteen tarvittavat korjaustyöt.

Älä käytä tuotetta räjähdysvaarallisilla alueilla tai aggressiivisissa ympäristöissä.

 Tyhjiä paristoja ei saa hävittää talousjätteen mukana. Huolehdi ympäristöstä ja vie ne kansallisten ja paikallisten säännösten mukaisesti järjestettyihin keräyspisteisiin. Tuotetta ei saa hävittää kotitalousjätteen mukana. Hävitä laite asianmukaisesti maassasi voimassa olevien säädösten mukaisesti. Noudata kansallisia ja maakohtaisia määräyksiä. Ota yhteyttä paikallisiin viranomaisiin tai kauppiaseesi saadaksesi tietoa hävittämisestä.



CE-merkki

TEKNISET ARVOT

	LDM 45	LDM 100
Optiikka	15 mm x 9 mm	18 mm
Mittausalue		
Vähimmäisetäisyys	45 m (Toleranssi: 45,1 m)	100 m (Toleranssi: 101 m)
Enimmäisetäisyys	0,05 m	0,05 m
Etäisyysmittaus		
Tyypillinen toleranssi (koskee 100 % taustaheijastusta (valkoiseksi maalattu seinä), vähäistä taustavalaisua, 25 °C)	± 2,0 mm (lisäksi tulee ottaa huomioon lisätoleranssina 0,1 mm/m)	± 2,0 mm (lisäksi tulee ottaa huomioon lisätoleranssina 0,1 mm/m)
Enimmäistoleranssi (koskee kohteita vähäisellä heijastuksella, korkealla taustavalaisulla tai lämpötiloilla, jotka lähenevät ylemppää/alempaa raja-arvoa)	± 4,0 mm (lisäksi tulee ottaa huomioon lisätoleranssina 0,15 mm/m)	± 4,0 mm (lisäksi tulee ottaa huomioon lisätoleranssina 0,15 mm/m)
Pienin näytettävissä oleva yksikkö	1,0 mm	1,0 mm
Laserpisteen koko		
16 m etäisyydellä:	25 x 50 mm	25 x 50 mm
Laserluokka	2	2
Lasertyyppi	635 nm, < 1 mW	635 nm, < 1 mW
Lasersäteen pystykulma vaakakulma	+1 aste 1 aste	+1 aste 1 aste
Näyttötyyppi	LCD (31,5 mm x 40 mm)	LCD (31,5 mm x 40 mm)
Automaattinen laserin sammutus	90 sekuntia	90 sekuntia
Automaattinen laitteen sammutus	180 sekuntia	180 sekuntia
Virransyöttö	AAA 2x (alkaline-paristo)	AAA 2x (alkaline-paristo)
Pariston kestoaika	8000 (yksittäismittausta)	8000 (yksittäismittausta)
Työlämpötila-alue	-0°C - +40°C	-0°C - +40°C
Säilytyslämpötila-alue	-10°C - +70°C	-10°C - +70°C
Paino ilman paristoa	87 g	122 g
Suojaluokka	IP54 (pöly- ja roiskevesisuojaattu)	IP54 (pöly- ja roiskevesisuojaattu)

TARKOITUKSENMUKAINEN KÄYTTÖ

Lasermittaria voidaan käyttää etäisyyksien ja kaltevuuksien mittaamiseen.

Älä käytä tuotetta ohjeiden vastaisesti.

VIRHEKOODITAUUKKO

Koodi	Kuvaus	Poisto
Err500	Laitteisto-ongelmat	Kytke mittauslaite pois päältä ja uudelleen päälle. Mikäli ongelma pysyy, tuo mittauslaite lähimpään huoltopisteeseen.

YHTEENVETO

TILARIVI

- ▶ Viitemittauspiste, mittauslaji, mittauskulma (vain LDM 100), mittaustaso (vain LDM 100)

NÄYTTÖRUUTU

- ▶ Valikko
- ▶ Mittaukset
- ▶ Asetukset

YLÖSPÄIN / LISÄÄ

- ▶ Siirry valikossa ylöspäin
- ▶ Lisää arvo

MITTAUS / OK

- ▶ Kytke laser päälle
- ▶ Tallenna mittausarvo
- ▶ Valitse valikossa OK

VALIKKO

- ▶ Käyttöhistoria
- ▶ Mittaus
- ▶ Asetukset

ALASPÄIN / VÄHENNÄ

- ▶ Siirry valikossa alaspäin
- ▶ Vähennä arvo

PYYHINTÄ / PÄÄLLE/POIS

- ▶ PÄÄLLE / POIS (pidä painiketta painettuna, kunnes laite antaa merkkiäänä)
- ▶ Pyyhi mittausarvo

MITTAUSPISTE

- ▶ Takana (vakioasetus)
- ▶ Edessä
- ▶ Nurkka (toimentuu automaattisesti kääntämällä puikko auki)

MITTAUS

- ▶ Kytke laser päälle
- ▶ Tallenna mittausarvo

VAIHDA PARISTOT

- ▶ Paristot täytyy vaihtaa, kun pariston merkki vilkkuu.

1

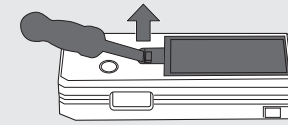

2

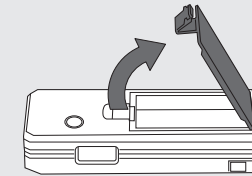

3

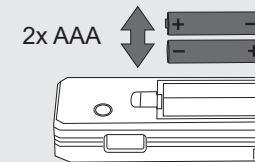

4

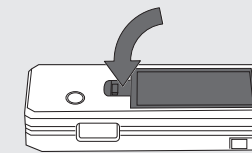

JALUSTA

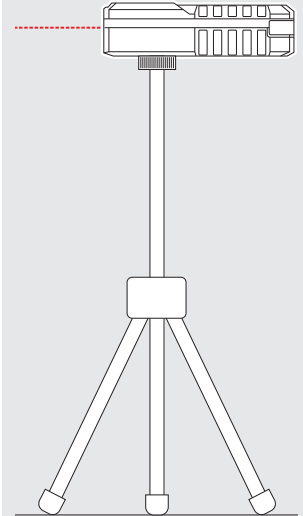

NURKKAPUIKKO

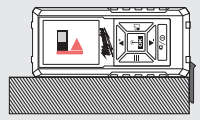
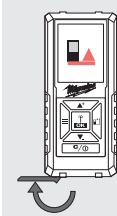
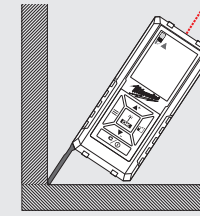

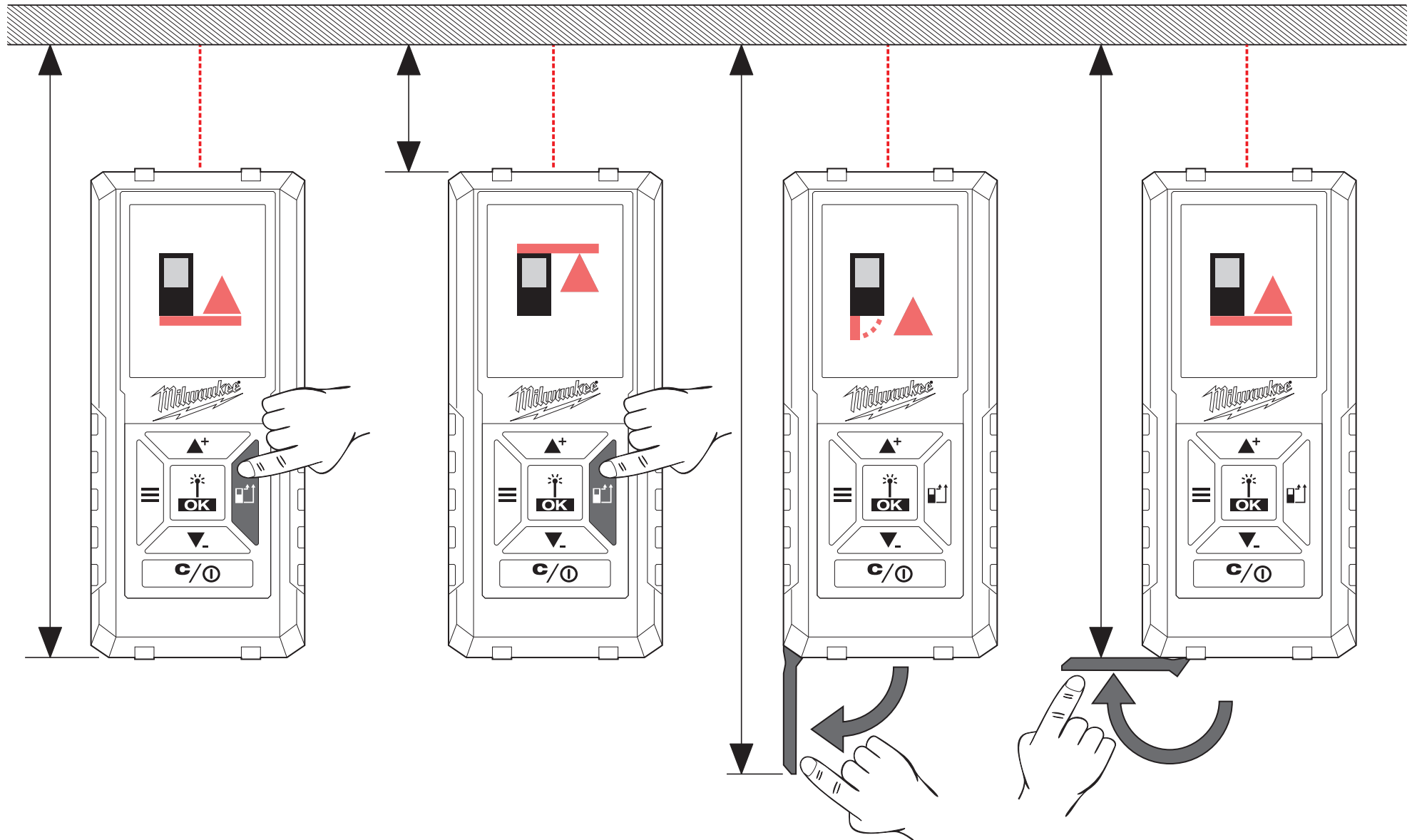

VALIKKO

KÄYTTÖHISTORIA

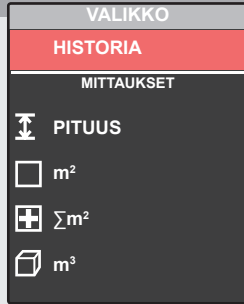

Näytössä on viimeiset 30 mittausta/laskelmaa Pinta-alan, kokonaispinta-alan, tilavuuden jne. yksittäisiä laskelmia ei tallenneta KÄYTTÖHISTORIAAN, vaan ainoastaan laskelmien tulos.

Voit pyyhkiä merkinnän painamalla C/PÄÄLLE/POIS -painiketta.

KÄYTTÖHISTORIAAN talletettuihin arvoihin voidaan lisätä tai niistä vähentää mittauksia/laskelmia. Vain saman lajin mittauksia (pituus, pinta-ala, tilavuus jne.) voidaan suorittaa.

Laskelman suorittaminen:

1. Valitse KÄYTTÖHISTORIASTA yksi mittaustapa painikkeiden ▲⁺ ▼⁻ avulla.
2. Paina OK-painiketta.
3. Suorita laskelmaan tarvittavat mittaukset.
4. Paina OK-näppäintä tallentaaksesi uuden laskelman KÄYTTÖHISTORIAAN.

MITTAUS

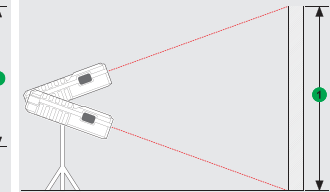
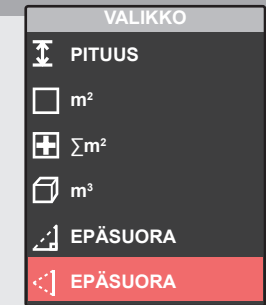
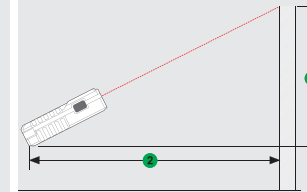
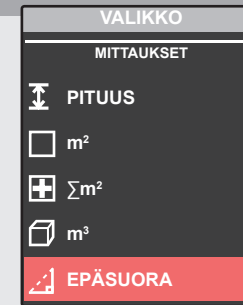
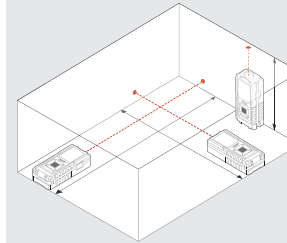
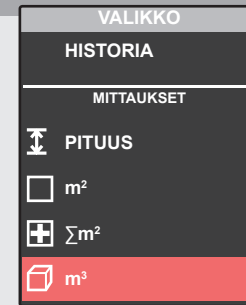
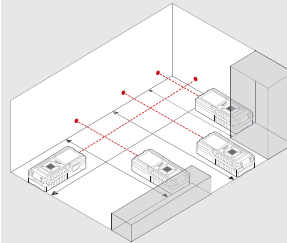
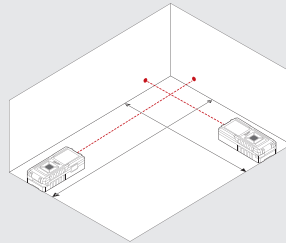
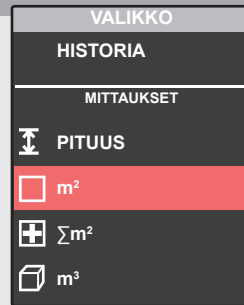
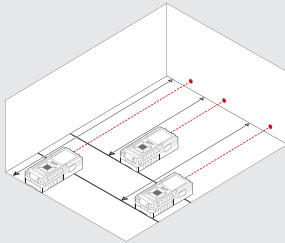
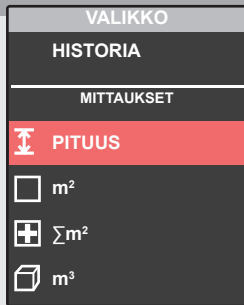

ASETUKSET

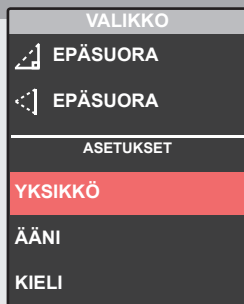

Valitse haluamasi mittayksikkö.

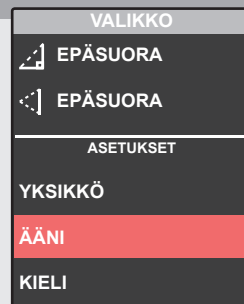

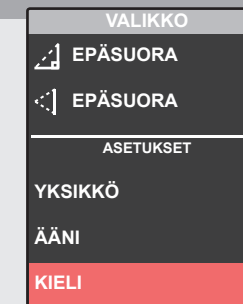

Merkkiääni päälle/pois.

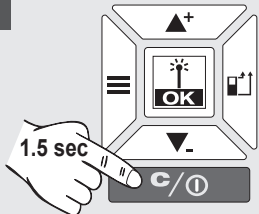
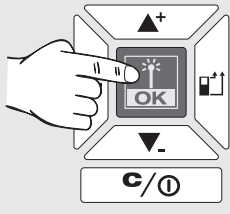
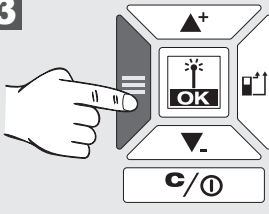
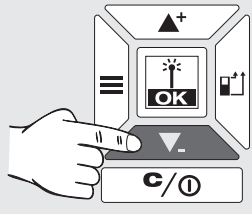
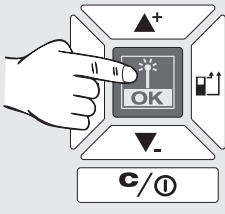
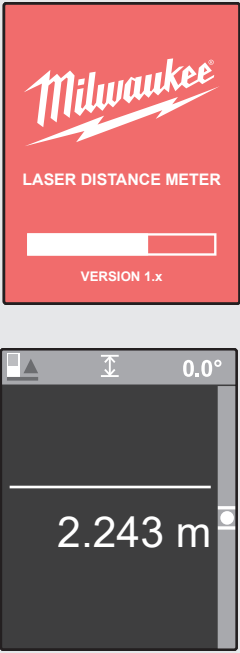
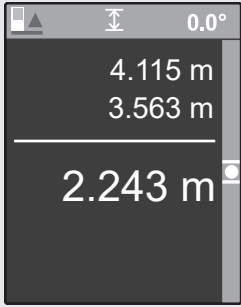

Valitse kieli.

ALOITTAMINEN

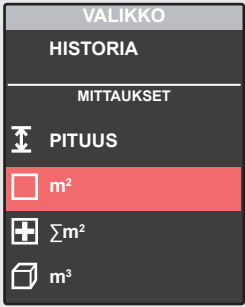
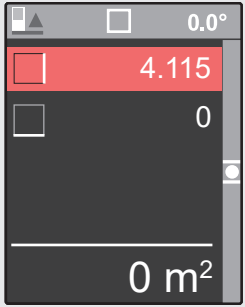
<p>1</p> 	<p>2</p> 	<p>3</p> 	<p>4</p> 	<p>5</p> 
				
<p>Käynnistämisen jälkeen laitteeseen kytkeytyy automaattisesti PITUUDENMITTAUSTAPA.</p>	<p>Suorita PITUUDENMITTAUS tai ...</p>	<p>... paina Valikko-näppäintä siirtyäksesi valikkoon ...</p>	<p>... ja valitse joku muu käyttötapa nuolinäppäimillä ▲▼ ja ...</p>	<p>... ja toimenna tämä käyttötapa painamalla OK-näppäintä.</p>

PITUUDEN MITTAAMINEN

0

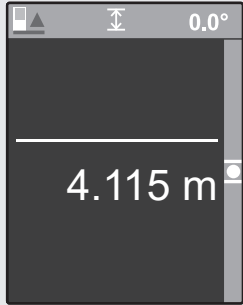

Mittausarvo on valkoinen = arvo mitattu

1

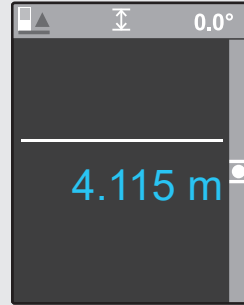
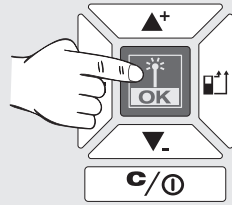

Mittausarvo on sininen = arvo tallennettu välimuistiin

2

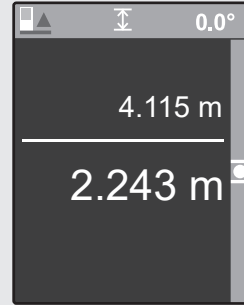
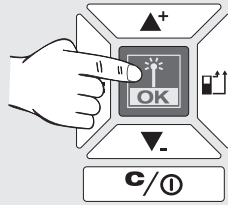

3

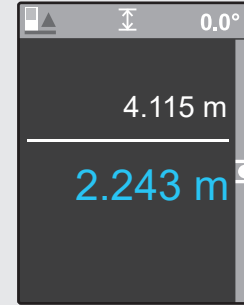
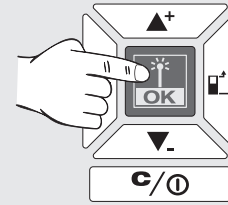

4

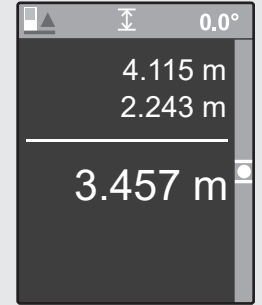
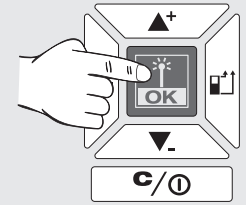

5

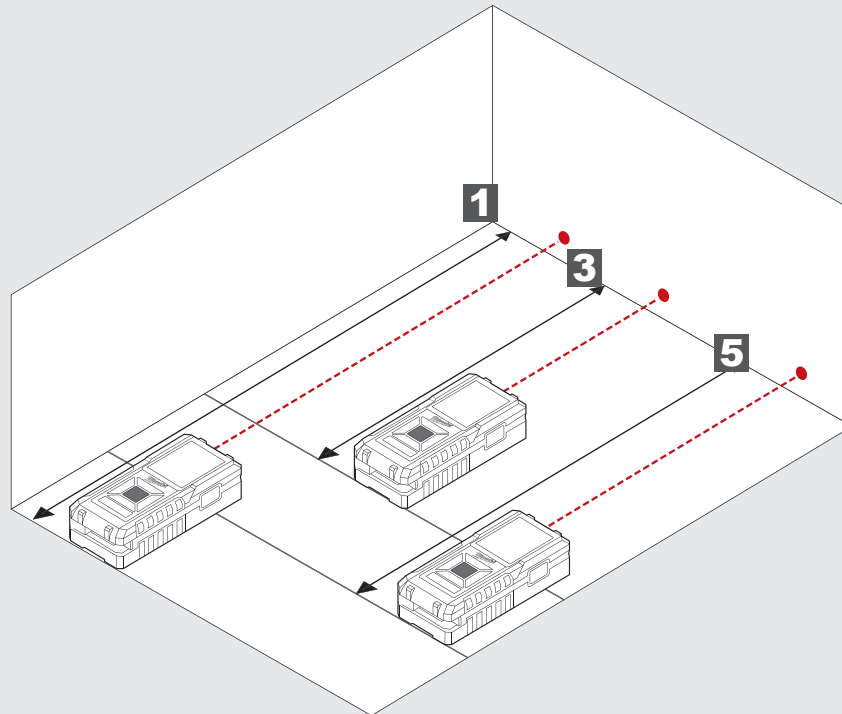
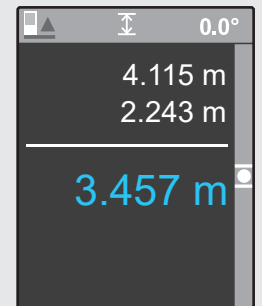
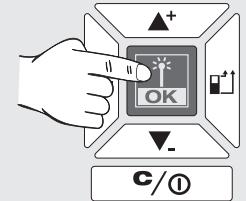

PINTA-ALAN MITTAAMINEN

0

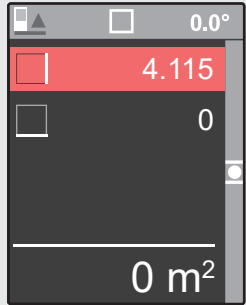

1

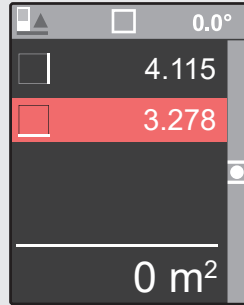
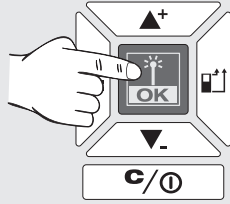

2

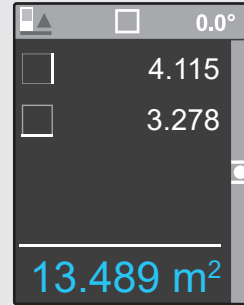
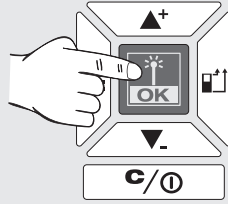

2

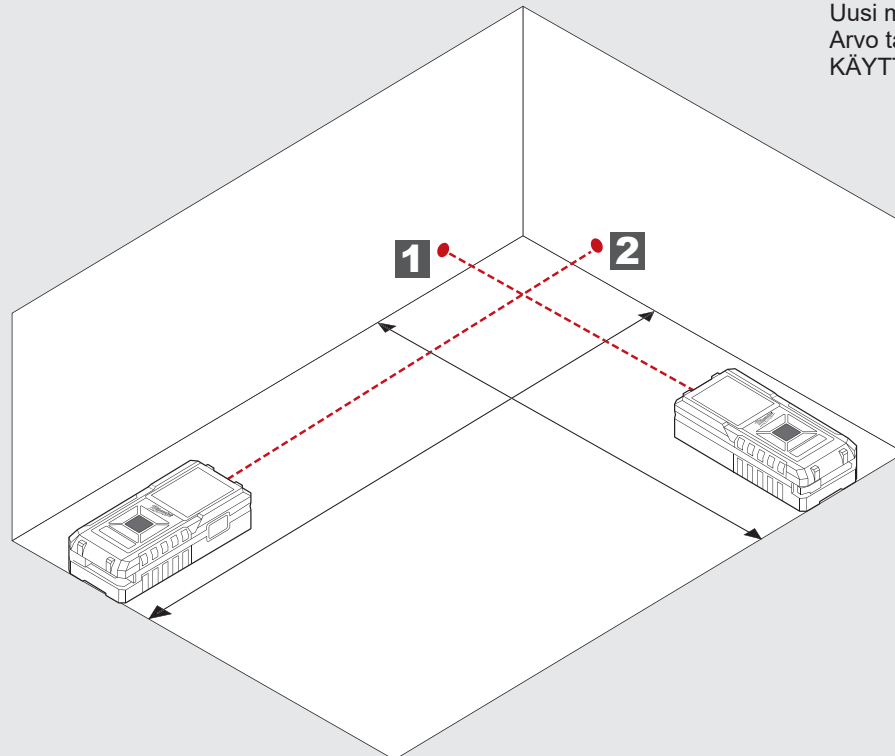
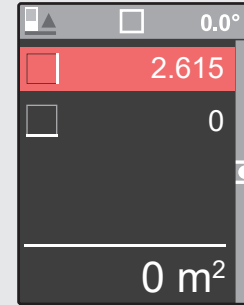
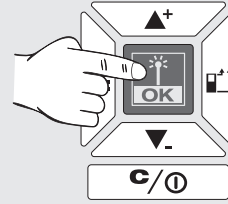

Uusi mittaus.
Arvo tallennetaan
KÄYTTÖHISTORIAAN.

KOKONAISPINTA-ALAN MITTAAMINEN

0

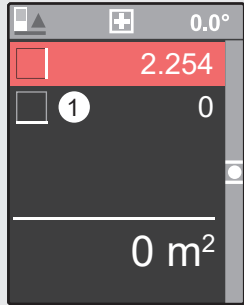

1

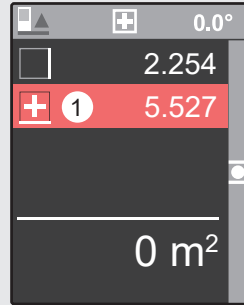
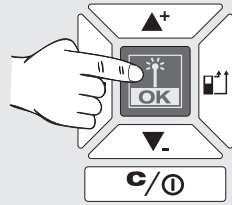

2

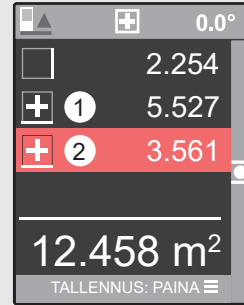
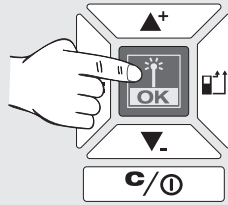

3

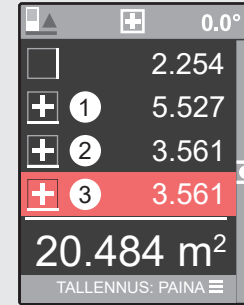
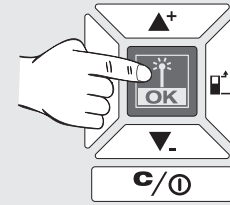

4

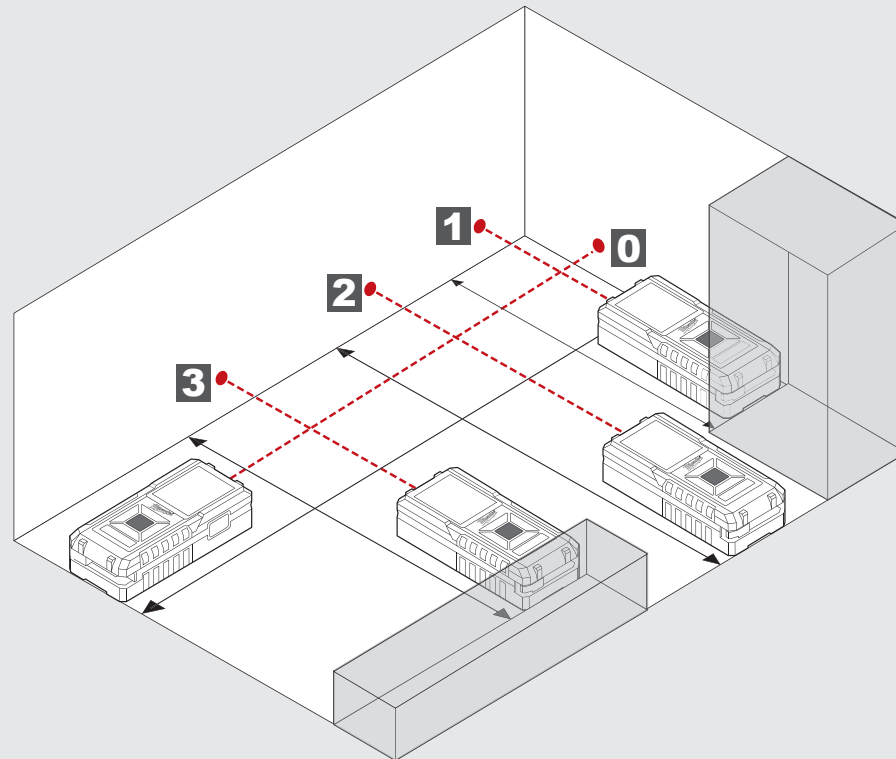
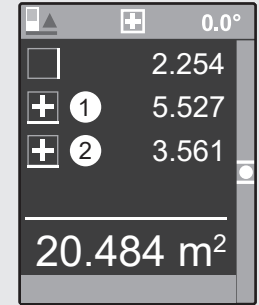
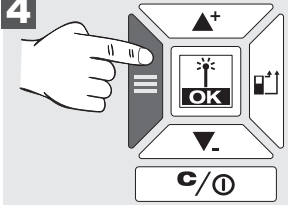

4

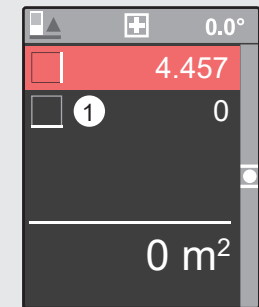
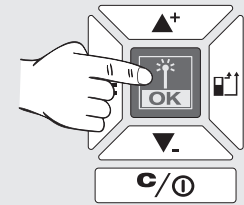

Uusi mittaus.
Arvo tallennetaan
KÄYTTÖHISTORIAAN.

TILAVUUDEN MITTAAMINEN

0

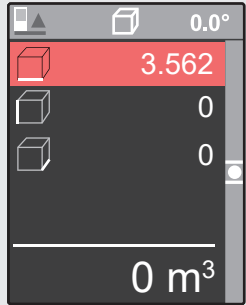

1

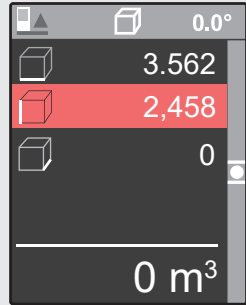
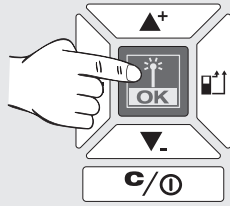

2

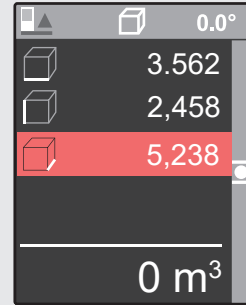
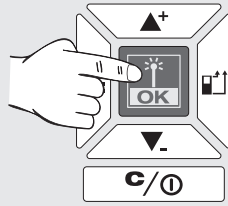

3

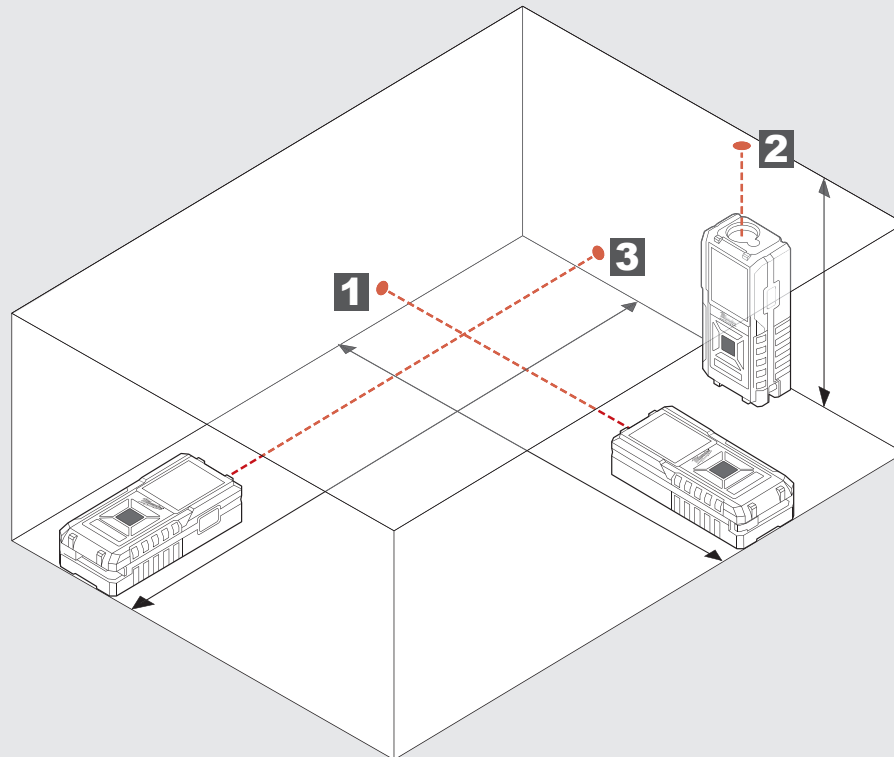
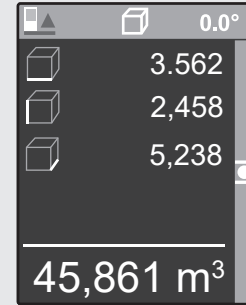
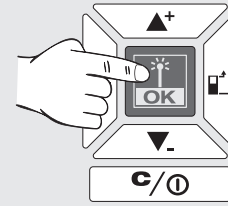

EPÄSUORA KORKEUDEN / PITUUDEN MITTAAMINEN (VAIN LDM 100)

0

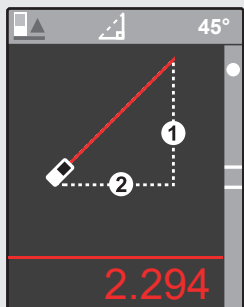

1

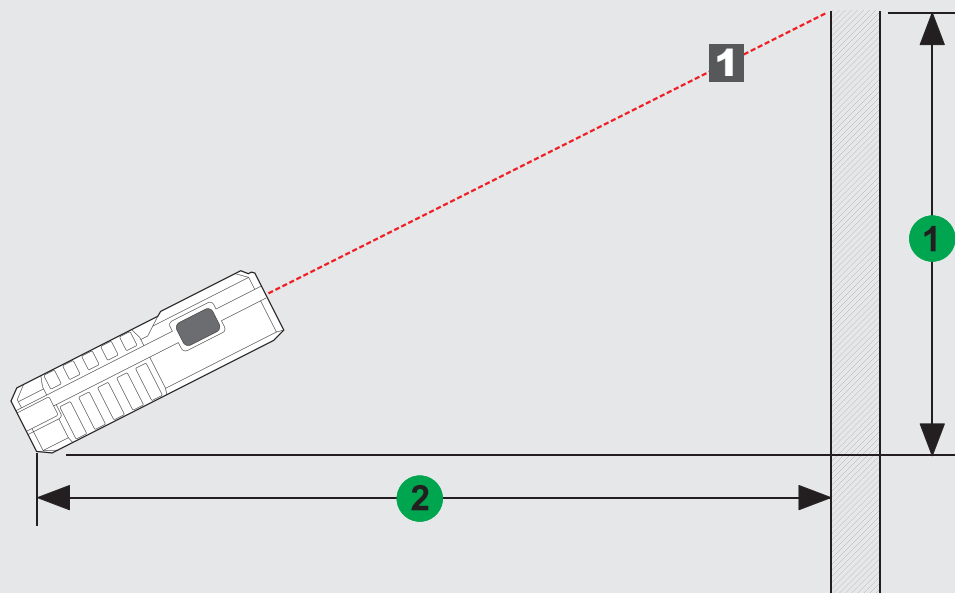
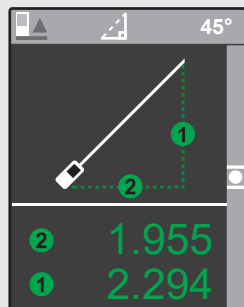
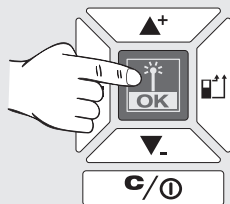

EPÄSUORA KORKEUDEN MITTAAMINEN (VAIN LDM 100)

0

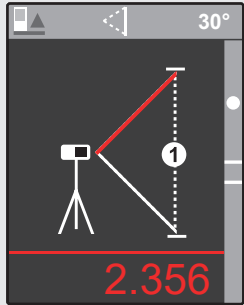

1

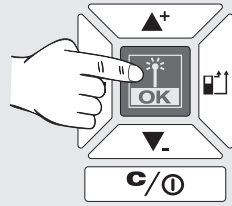

2

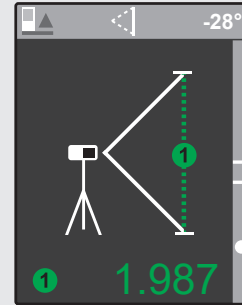
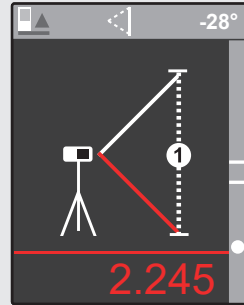
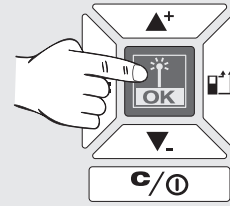

Käytä jalustaa tai muuta
tukevaa alustaa, kun mittaat
kaksi eri pituutta.

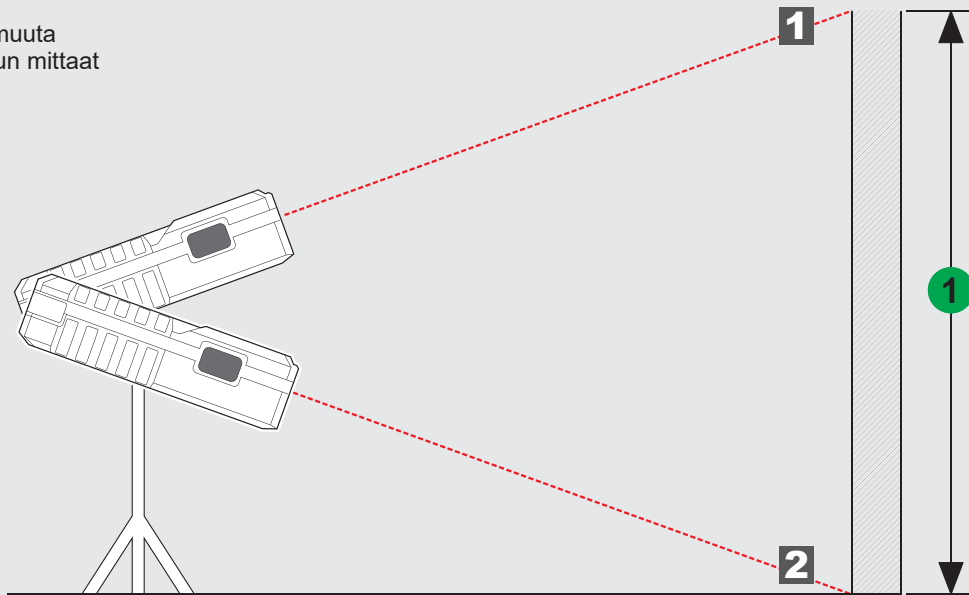

ΠΕΡΙΕΧΟΜΕΝΑ

Σημαντικές οδηγίες ασφαλείας	1
Τεχνικά στοιχεία	2
Χρήση σύμφωνα με το σκοπό προορισμού.....	2
Πίνακας κωδικών σφαλμάτων	2
Συνοπτική εικόνα	3
Σημείο μέτρησης.....	4
Μενού	5
Έναρξη	6
Μέτρηση μήκους.....	7
Μέτρηση επιφάνειας	8
Μέτρηση συνολικής επιφάνειας.....	9
Μέτρηση όγκου.....	10
Έμμεση μέτρηση ύψους/μήκους (μόνο με LDM 100).....	11
Έμμεση μέτρηση ύψους (μόνο με LDM 100).....	12

ΣΗΜΑΝΤΙΚΕΣ ΟΔΗΓΙΕΣ ΑΣΦΑΛΕΙΑΣ



Μη χρησιμοποιήσετε το προϊόν χωρίς πρώτα να διαβάσετε τις Οδηγίες ασφαλείας και το Εγχειρίδιο χρήσης στο συνοδευτικό CD.

Κατηγορία Laser

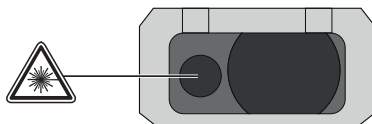

ΠΡΟΕΙΔΟΠΟΙΗΣΗ:

Πρόκειται για ένα προϊόν λέιζερ Κλάσης 2 σύμφωνα με το πρότυπο EN60825-1:2014 .



Αποφύγετε την απευθείας έκθεση των ματιών σας στην ακτίνα laser. Κάτι τέτοιο μπορεί να προκαλέσει προσωρινή θάμβωση.

Μην κοιτάζετε απευθείας μέσα στην ακτίνα λέιζερ και μην τη στρέψετε χωρίς λόγο προς άλλα άτομα.

Μην τυφλώνετε άλλα άτομα.

Προειδοποίηση:

Μην χρησιμοποιείτε την συσκευή laser κοντά σε παιδιά και μην επιτρέπετε σε παιδιά να την χρησιμοποιήσουν.

Προσοχή! Η ακτίνα laser μπορεί να αντανάκλασθεί πάνω σε μια ανακλώσα επιφάνεια πίσω στον χειριστή ή σε άλλα πρόσωπα. ηρείτε απόσταση ασφαλείας από τα κινούμενα μέρη.

Πραγματοποιείτε τακτικές δοκιμαστικές μετρήσεις. Ιδίως πριν, στη διάρκεια και μετά από σημαντικές μετρήσεις.

Προσέχετε για εσφαλμένες μετρήσεις εάν το προϊόν είναι ελαττωματικό, εάν έχει πέσει κάτω, εάν έχει τύχει κακής μεταχείρισης ή εάν έχει τροποποιηθεί.

Προσοχή: Η χρήση στοιχείων ελέγχου και ρυθμίσεως ή η εκτέλεση διεργασιών άλλων από αυτές που ορίζονται στο εγχειρίδιο χρήσης μπορεί να οδηγήσουν σε επικίνδυνη έκθεση σε ακτινοβολία.

Η συσκευή μέτρησης αποστάσεως με ακτίνα laser έχει συγκεκριμένη περιοχή μέτρησης. (Βλέπε παράρτημα Τεχνικά χαρακτηριστικά). Μετρήσεις μικρότερων ή μεγαλύτερων αποστάσεων από την περιοχή μέτρησης έχουν ως αποτέλεσμα απώλεια ακρίβειας. Η λειτουργία κάτω από δυσμενείς συνθήκες όπως πολύ κρύο ή ζέστη, έντονη ηλιοφάνεια, βροχή, χιόνι, ομίχλη ή άλλες συνθήκες που δυσχεραίνουν την ορατότητα έχουν ως αποτέλεσμα μετρήσεις μειωμένης ακρίβειας.

Αν μεταφέρετε την συσκευή μέτρησης αποστάσεως με ακτίνα laser από ένα θερμό περιβάλλον σε ένα ψυχρό (ή το αντίθετο), περιμένετε μέχρι να προσαρμοστεί η θερμοκρασία της συσκευής στις καινούριες συνθήκες.

Φυλάξτε την συσκευή μέτρησης αποστάσεως με ακτίνα laser πάντα σε κλειστούς χώρους και προφυλάξτε την από κραδασμούς, δονήσεις ή ακραίες θερμοκρασίες.

Προφυλάξτε την συσκευή μέτρησης αποστάσεως με ακτίνα laser από σκόνη, υγρασία και υψηλή ατμοσφαιρική υγρασία. Κάτι τέτοιο μπορεί να καταστρέψει εξαρτήματα στο εσωτερικό της ή να επηρεάσει την ακρίβεια μέτρησης.

Μην χρησιμοποιείτε δραστικά απορρυπαντικά ή διαλυτικά. Καθαρίστε την συσκευή μόνο με ένα καθαρό και μαλακό πανί.

Αποφύγετε δυνατά χτυπήματα ή πτώση της συσκευής μέτρησης αποστάσεως με ακτίνα laser. Η ακρίβεια μέτρησης πρέπει να ελεγχθεί μετά από μια πτώση ή μετά από άλλες μηχανικές καταπονήσεις.

Απαιτούμενες εργασίες επισκευής στην συσκευή laser επιτρέπεται να διενεργούνται μόνο από εξουσιοδοτημένο ειδικευμένο προσωπικό.

Μη χρησιμοποιείτε το προϊόν σε περιοχές που ενέχουν κίνδυνο έκρηξης ή σε επιθετικά περιβάλλοντα.



Οι άδεις μπαταρίες δεν πρέπει να απορρίπτονται μαζί με τα οικιακά απορρίμματα. Φροντίστε το περιβάλλον και μεταφέρετέ τις σε σημεία αποκομιδής σύμφωνα με τους εθνικούς ή τοπικούς κανονισμούς. Το προϊόν δεν πρέπει να απορρίπτεται μαζί με τα οικιακά απορρίμματα. Φροντίστε για την κατάλληλη απόρριψη του προϊόντος σύμφωνα με τις εθνικές διατάξεις που ισχύουν στη χώρα σας. Τηρείτε τις εθνικές διατάξεις διάθεσης απορριμμάτων.

Απευθυνθείτε στις τοπικές δημόσιες υπηρεσίες ή στον έμπορο για να πληροφορηθείτε σχετικά με την απόρριψη.



Σήμα συμμόρφωσης CE

ΤΕΧΝΙΚΑ ΣΤΟΙΧΕΙΑ

	LDM 45	LDM 100
Φακός	15 mm x 9 mm	18 mm
Περιοχή μέτρησης		
Ελάχιστη απόσταση	45 m (Ανοχή: 45,1 m)	100 m (Ανοχή: 101 m)
Μέγιστη απόσταση	0,05 m	0,05 m
Μέτρηση απόστασης		
Τυπική ανοχή (ισχύει για 100 % αντανάκλαση στόχου (λευκό τοίχο), ελάχιστο φωτισμό φόντου, 25 °C)	± 2,0 χιλ. (Θα έπρεπε να υπολογίζεται μια επιπρόσθετη ανοχή ύψους 0,1 χιλ./μ)	± 2,0 χιλ. (Θα έπρεπε να υπολογίζεται μια επιπρόσθετη ανοχή ύψους 0,1 χιλ./μ)
Μέγιστη ανοχή (ισχύει για στόχους με ελάχιστη αντανάκλαση, έντονο φωτισμό φόντου ή θερμοκρασίες που πλησιάζουν την κατώτερη/υψηλότερη τιμή)	± 4,0 χιλ. (Θα έπρεπε να υπολογίζεται μια επιπρόσθετη ανοχή ύψους 0,15 χιλ./μ)	± 4,0 χιλ. (Θα έπρεπε να υπολογίζεται μια επιπρόσθετη ανοχή ύψους 0,15 χιλ./μ)
Μικρότερη μονάδα ένδειξης	1,0 mm	1,0 mm
Μέγεθος κουκίδας λείζερ		
16 μ απόσταση:	25 x 50 mm	25 x 50 mm
Κατηγορία λείζερ	2	2
Τύπος λείζερ	635 nm, < 1 mW	635 nm, < 1 mW
Ακτίνας laser		
Κατακόρυφη γωνία	+1 μοίρα	+1 μοίρα
Οριζόντια γωνία	±1 μοίρα	±1 μοίρα
Τύπος οθόνης	LCD (25mm x 25 mm)	LCD (25mm x 25 mm)
Αυτόματη απενεργοποίηση laser	90 δευτερόλεπτα	90 δευτερόλεπτα
Αυτόματη απενεργοποίηση συσκευής	180 δευτερόλεπτα	180 δευτερόλεπτα
Ηλεκτρική τροφοδοσία	AAA 2x (αλκαλική μπαταρία)	AAA 2x (αλκαλική μπαταρία)
Χρόνος ζωής μπαταρίας	8000 (μεμονωμένες μετρήσεις)	8000 (μεμονωμένες μετρήσεις)
Περιοχή θερμοκρασίας λειτουργίας	-0°C μέχρι +40°C	-0°C μέχρι +40°C
Περιοχή θερμοκρασίας αποθήκευσης	-10°C μέχρι +60°C	-10°C μέχρι +60°C
Βάρος χωρίς μπαταρία	87 g	122 g
Κατηγορία αντοχής για σκόνη και νερό	IP54	IP54

ΧΡΗΣΗ ΣΥΜΦΩΝΑ ΜΕ ΤΟ ΣΚΟΠΟ ΠΡΟΟΡΙΣΜΟΥ

Η συσκευή μέτρησης αποστάσεως με ακτίνα laser είναι κατάλληλη για μετρήσεις απόστασης και κλίσης.

Αυτή η συσκευή επιτρέπεται να χρησιμοποιηθεί μόνο σύμφωνα με τον αναφερόμενο σκοπό προορισμού.

ΠΙΝΑΚΑΣ ΚΩΔΙΚΩΝ ΣΦΑΛΜΑΤΩΝ

Κωδικός	Περιγραφή	Λύση
Err500	Προβλήματα υλισμικού	Απενεργοποιήστε και ενεργοποιήστε πάλι το όργανο μέτρησης. Συνεχίσει να υφίσταται το πρόβλημα, φέρτε το όργανο μέτρησης στο πιο κοντινό κέντρο εξυπηρέτησης πελατών.

ΣΥΝΟΠΤΙΚΗ ΕΙΚΟΝΑ

ΓΡΑΜΜΗ ΚΑΤΑΣΤΑΣΗΣ

- ▶ Σημείο αναφοράς για τη μέτρηση, είδος μέτρησης, γωνία μέτρησης (μόνο με LDM 100), επίπεδο μέτρησης (μόνο με LDM 100)

ΟΠΤΙΚΗ ΕΝΔΕΙΞΗ

- ▶ Μενού
- ▶ Μετρήσεις
- ▶ Ρυθμίσεις

ΠΡΟΣ ΤΑ ΠΑΝΩ / ΠΡΟΣΘΕΣΗ

- ▶ Στο μενού κίνηση προς τα πάνω
- ▶ Πρόσθεση τιμής

ΜΕΤΡΗΣΗ / OK

- ▶ Ενεργοποίηση λέιζερ
- ▶ Απομνημόνευση τιμής μετρήσεως
- ▶ Επιλέξτε OK στο μενού

ΜΕΝΟΥ

- ▶ Ιστορικό
- ▶ Μέτρηση
- ▶ Ρυθμίσεις

ΠΡΟΣ ΤΑ ΚΑΤΩ / ΑΦΑΙΡΕΣΗ

- ▶ Στο μενού κίνηση προς τα κάτω
- ▶ Αφαίρεση τιμής

ΔΙΑΓΡΑΦΗ / ΕΝΕΡΓΟΠΟΙΗΣΗ / ΑΠΕΝΕΡΓΟΠΟΙΗΣΗ

- ▶ ON / OFF (κρατήστε το πλήκτρο πατημένο, έως να ακούσετε έναν ηχητικό τόνο από τη συσκευή)
- ▶ Διαγραφή τιμής μετρήσεως

ΣΗΜΕΙΟ ΜΕΤΡΗΣΗΣ

- ▶ Πίσω (προεπιλεγμένη ρύθμιση)
- ▶ Εμπρός
- ▶ Γωνία (ενεργοποιείται αυτόματα μέσω ανοίγματος του αξονίσκου)

ΜΕΤΡΗΣΗ

- ▶ Ενεργοποίηση λέιζερ
- ▶ Απομνημόνευση τιμής μετρήσεως

ΑΛΛΑΓΗ ΜΠΑΤΑΡΙΩΝ

- ▶ Αλλάξτε τις μπαταρίες, όταν αναβοσβήνει το σύμβολο μπαταρίας.

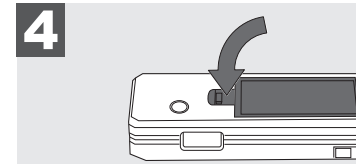
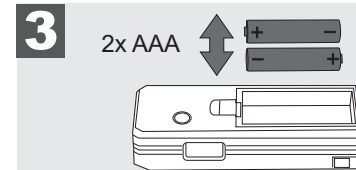
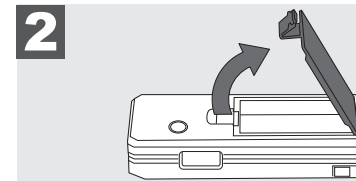
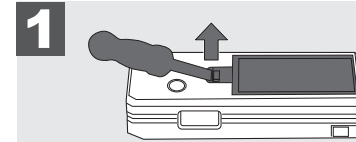

ΣΤΑΤΙΦ

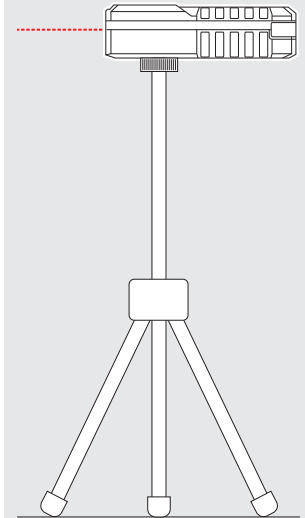

ΑΞΟΝΙΣΚΟΣ ΓΩΝΙΑΣ

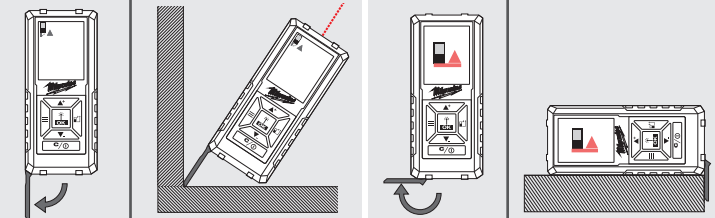

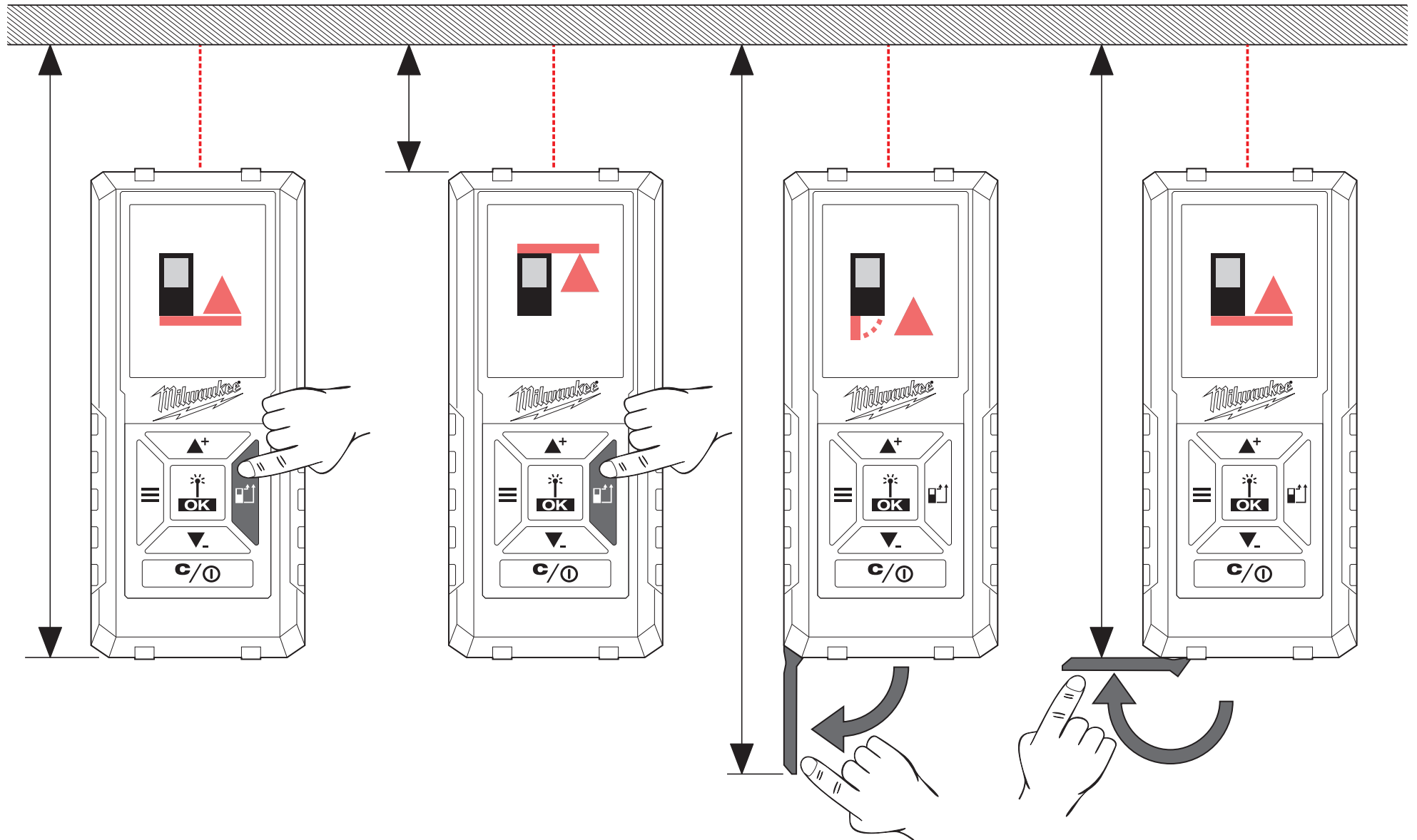

MENΟΥ

ΙΣΤΟΡΙΚΟ

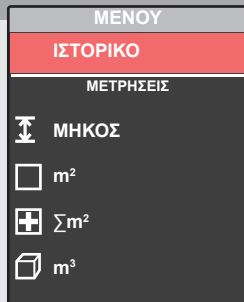

Ένδειξη των τελευταίων 30 μετρήσεων/ υπολογισμών.

Στο ΙΣΤΟΡΙΚΟ απομνημονεύεται μόνο το αποτέλεσμα των μετρήσεων όχι οι μεμονωμένες μετρήσεις για τον υπολογισμό της επιφάνειας, της συνολικής επιφάνειας, του όγκου κτλ.

Για να διαγράψετε μian καταχώριση, πιέστε το πλήκτρο C/ON/OFF.

Στις απομνημονευμένες τιμές του ΙΣΤΟΡΙΚΟΥ μπορείτε να προσθέτετε ή αφαιρείτε μετρήσεις/ υπολογισμούς. Μπορούν να πραγματοποιούνται υπολογισμοί του ίδιου είδους (μήκος, επιφάνεια, όγκος κτλ.).

Διεξαγωγή ενός υπολογισμού:

1. Χρησιμοποιήστε τα πλήκτρα ▲+ ▼-, για να επιλέξετε τη λειτουργία μέτρησης από το ΙΣΤΟΡΙΚΟ.
2. Πιέστε το πλήκτρο OK.
3. Πραγματοποιήστε τις αναγκαίες μετρήσεις για τον υπολογισμό.
4. Πιέστε το πλήκτρο OK, για να απομνημονεύσετε τον υπολογισμό στο ΙΣΤΟΡΙΚΟ.

ΜΕΤΡΗΣΗ

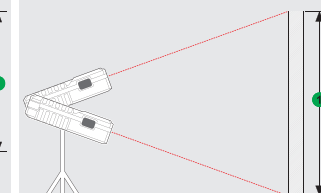
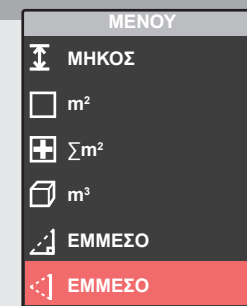
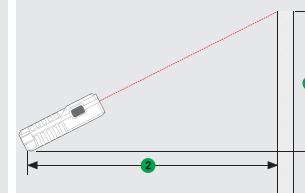
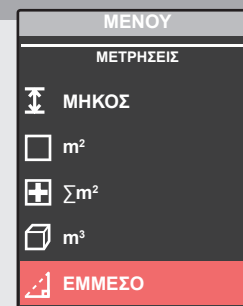
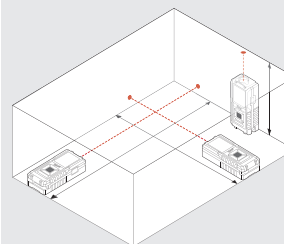
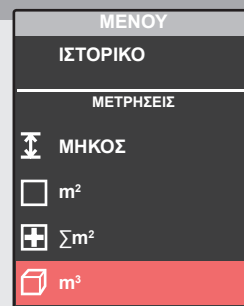
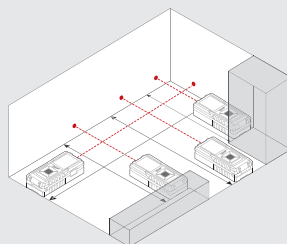
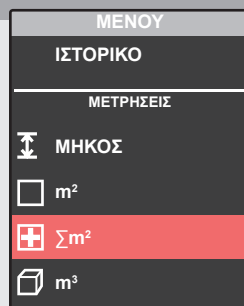
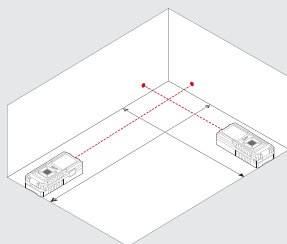
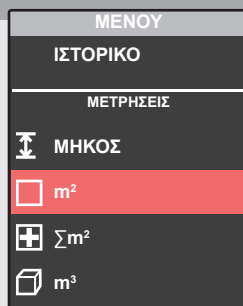
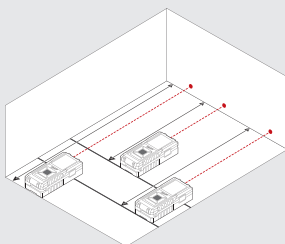
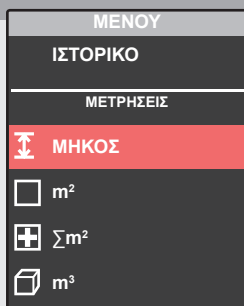

ΡΥΘΜΙΣΕΙΣ

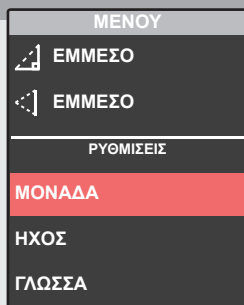

Επιλέξτε τη μονάδα μέτρησης που επιθυμείτε.

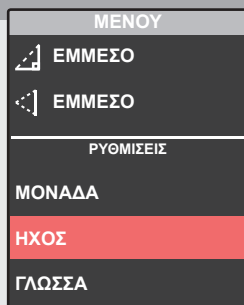

Ηχητικός τόνος on/off.

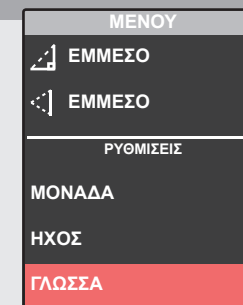

Επιλογή γλώσσας.

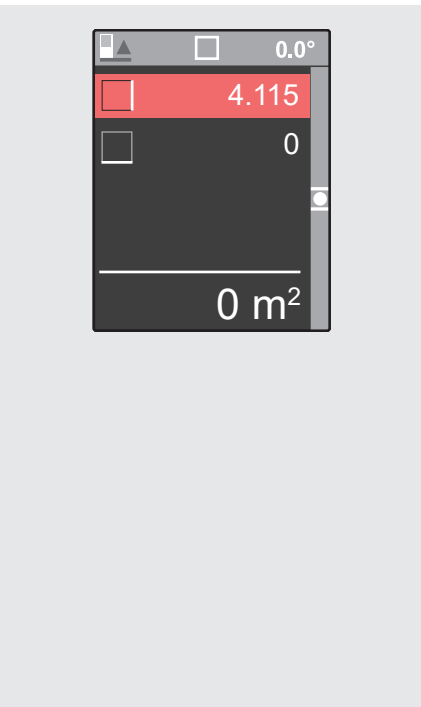
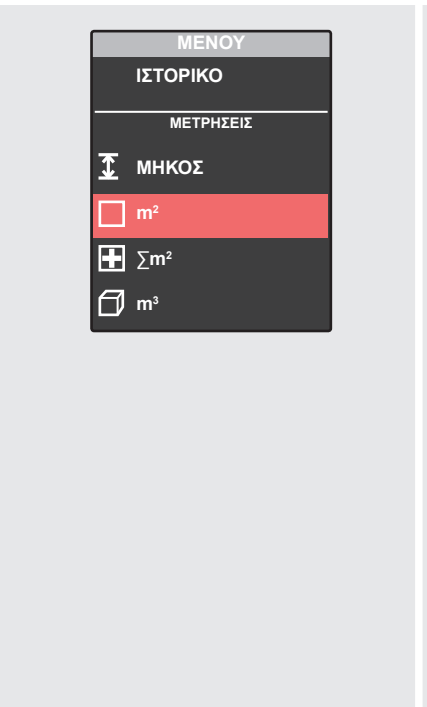
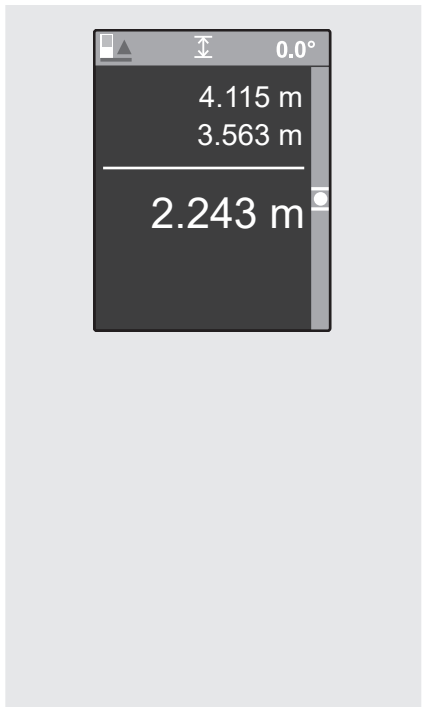
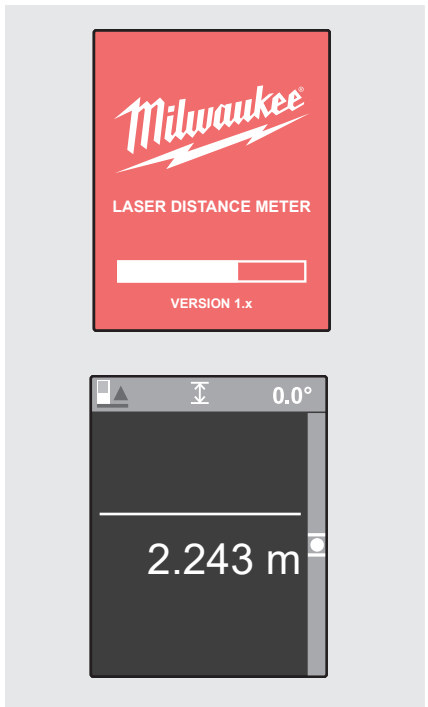
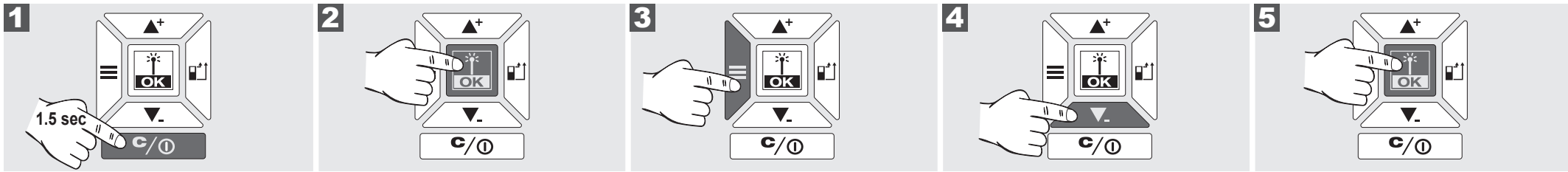

Μετά την ενεργοποίηση ενεργοποιείται η ΛΕΙΤΟΥΡΓΙΑ ΜΕΤΡΗΣΗΣ ΜΗΚΟΥΣ αυτόματα.

Πραγματοποιήστε μια ΜΕΤΡΗΣΗ ΜΗΚΟΥΣ ή ...

... πιάστε το πλήκτρο του μενού, για να μεταβείτε στο μενού ...

... και επιλέξτε ένα άλλο είδος λειτουργίας με τη βοήθεια των πλήκτρων ▲+ ▼- και ...

... και ενεργοποιήστε αυτό το είδος λειτουργίας, πιέζοντας το πλήκτρο OK.

ΜΕΤΡΗΣΗ ΜΗΚΟΥΣ

0

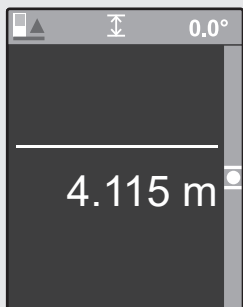

Τιμή μέτρησης λευκή = η τιμή μετρήθηκε

1

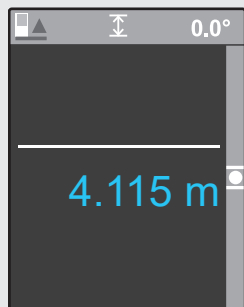
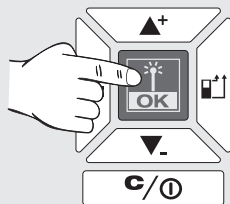

Τιμή μέτρησης μπλε = η τιμή απομνημονεύτηκε ενδιάμεσα

2

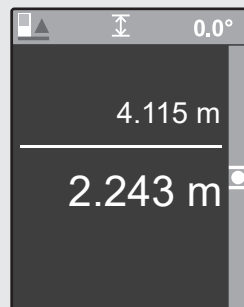
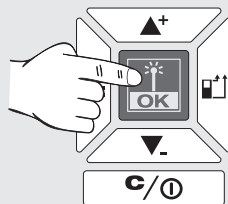

3

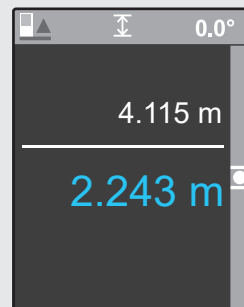
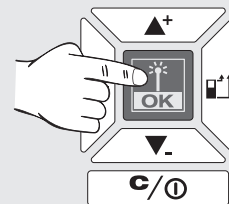

4

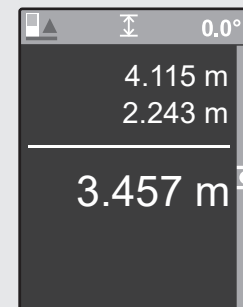
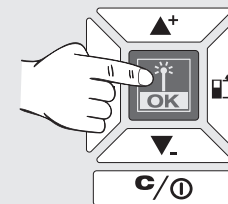

5

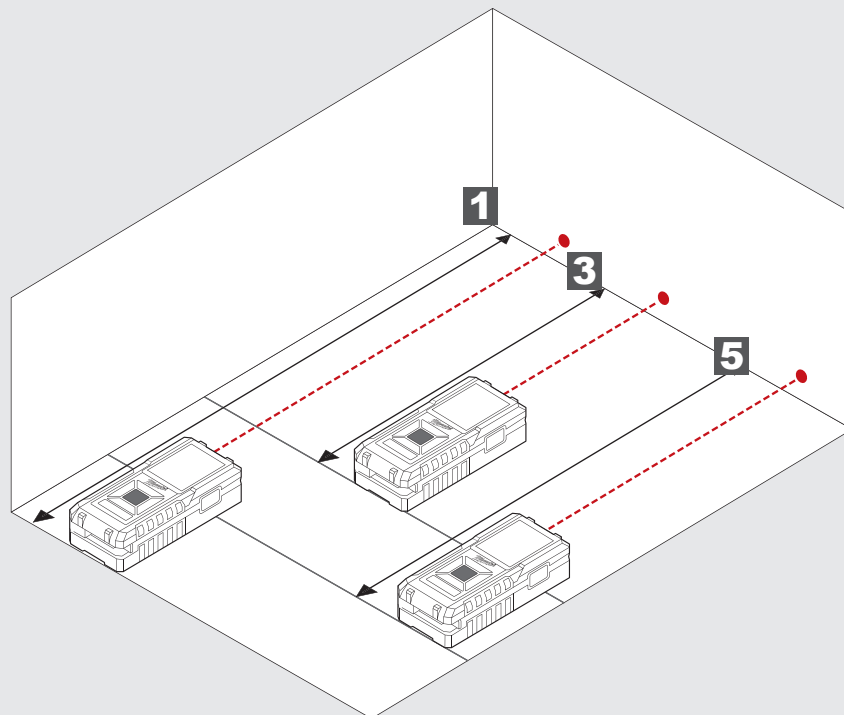
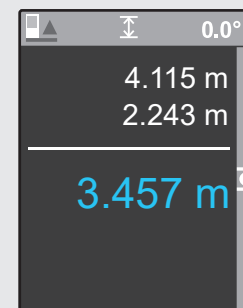
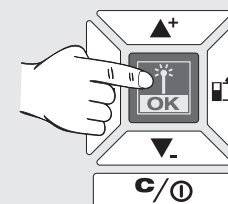

ΜΕΤΡΗΣΗ ΕΠΙΦΑΝΕΙΑΣ

0

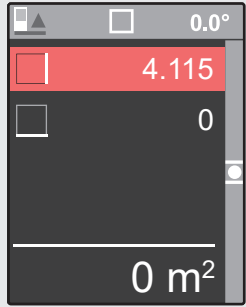

1

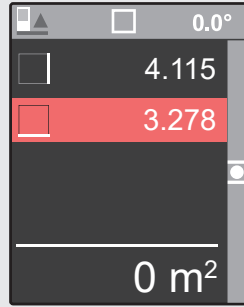
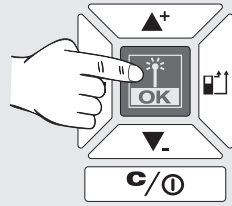

2

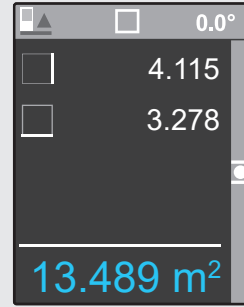
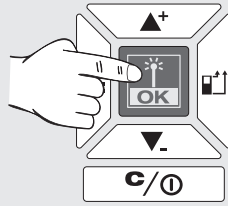

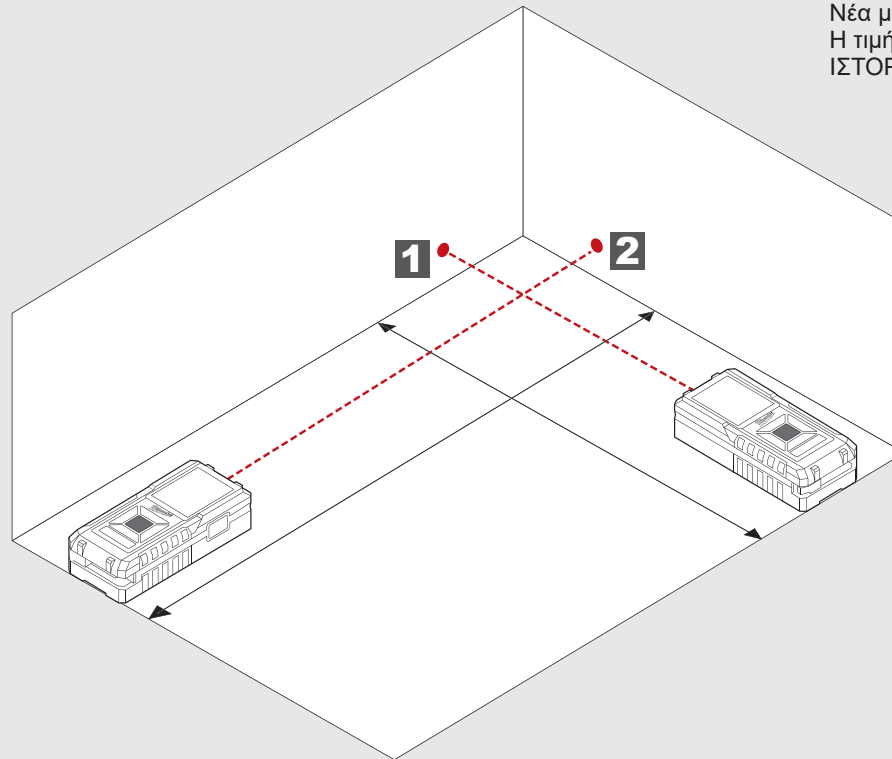
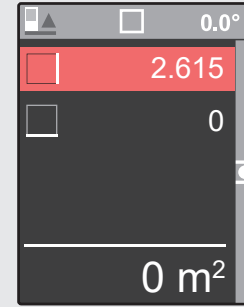
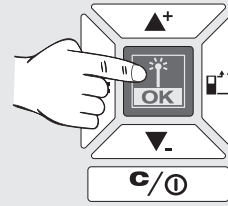

2

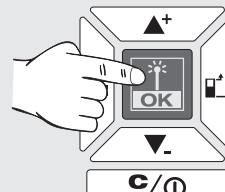
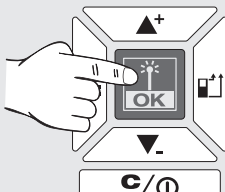
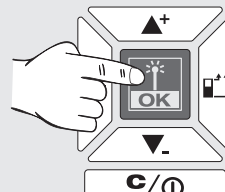
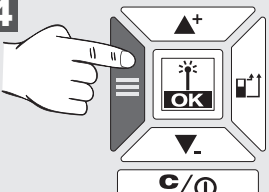

Νέα μέτρηση.
Η τιμή απομνημονεύεται στο
ΙΣΤΟΡΙΚΟ.

ΜΕΤΡΗΣΗ ΣΥΝΟΛΙΚΗΣ ΕΠΙΦΑΝΕΙΑΣ

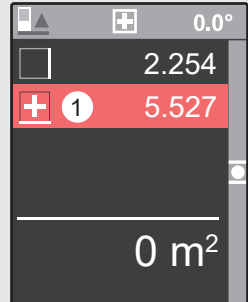
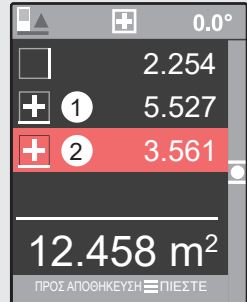
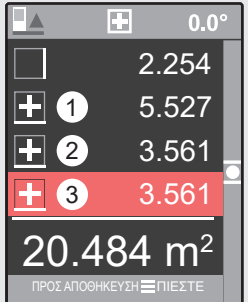
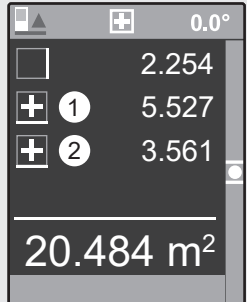
0	1 	2 	3 	4 
				

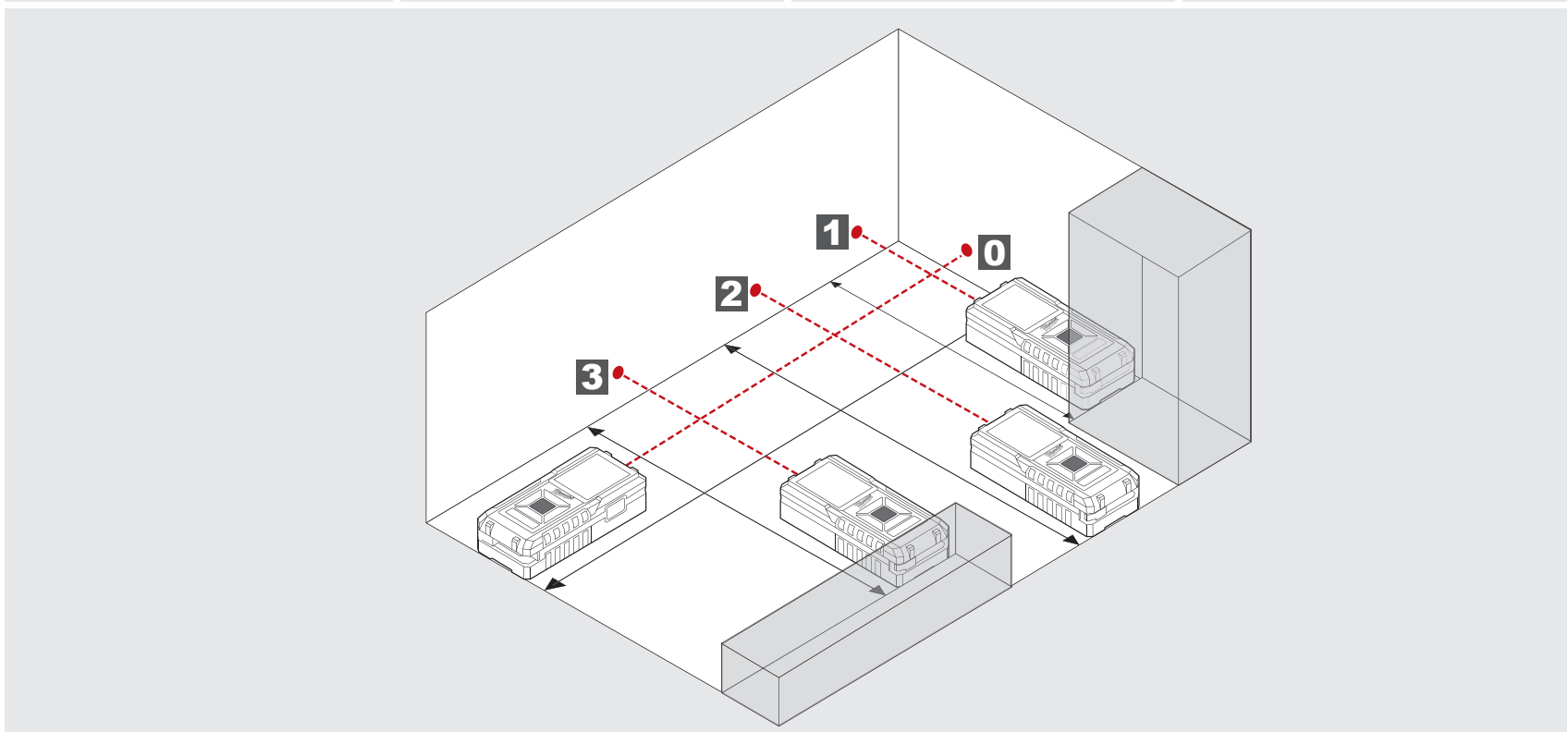

4

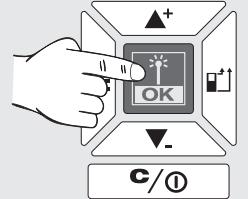
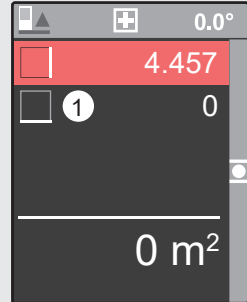
Νέα μέτρηση.
Το αποτέλεσμα απομνημονεύεται
στο ΙΣΤΟΡΙΚΟ.

0

1

2

3

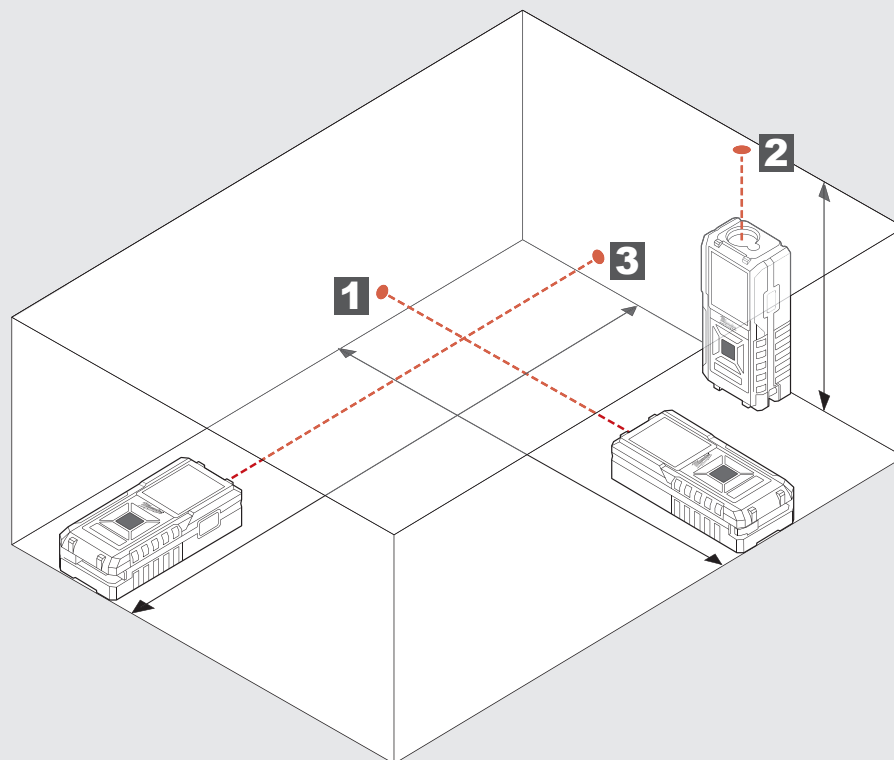
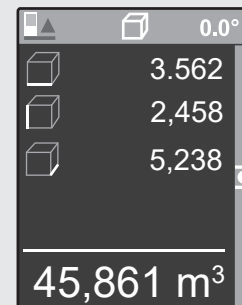
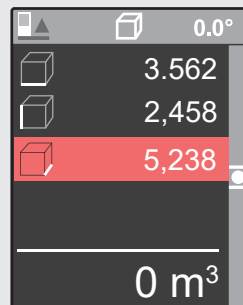
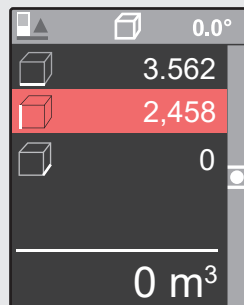
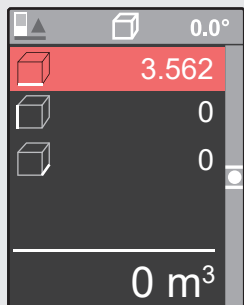
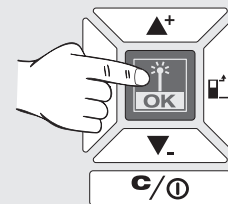
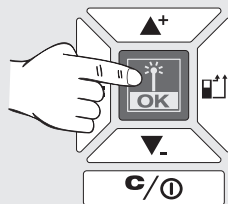
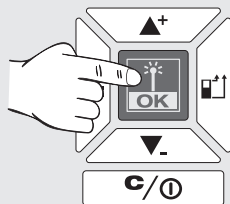

ΕΜΜΕΣΗ ΜΕΤΡΗΣΗ ΥΨΟΥΣ/ΜΗΚΟΥΣ (ΜΟΝΟ ΜΕ LDM 100)

0

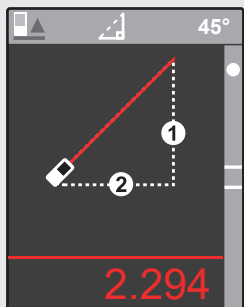

1

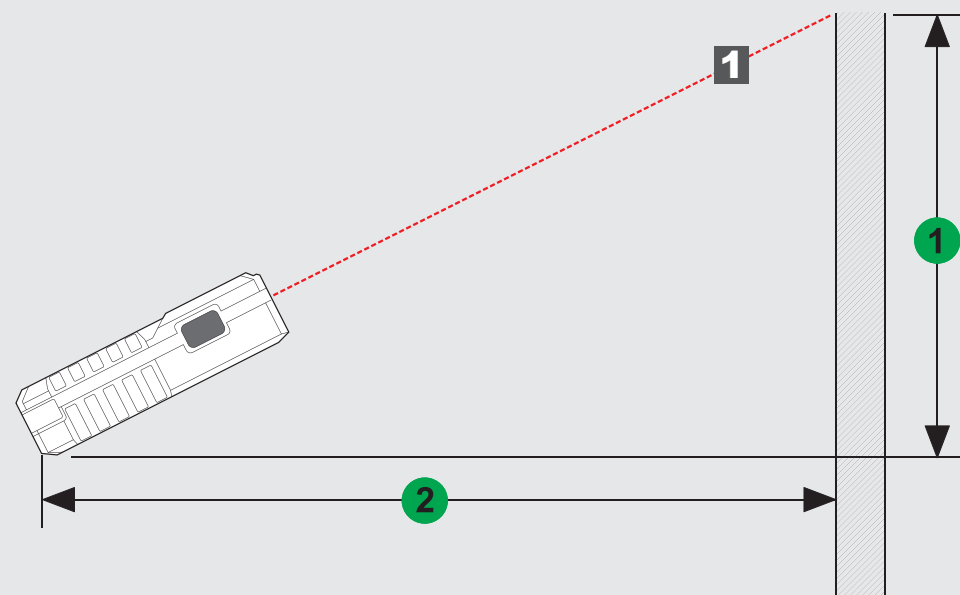
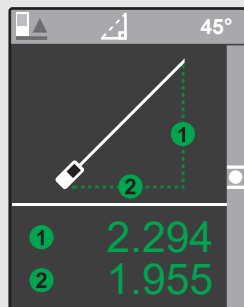
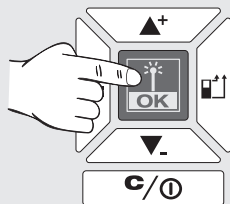

ΕΜΜΕΣΗ ΜΕΤΡΗΣΗ ΥΨΟΥΣ (ΜΟΝΟ ΜΕ LDM 100)

0

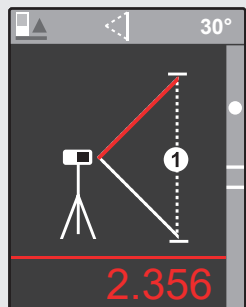

1

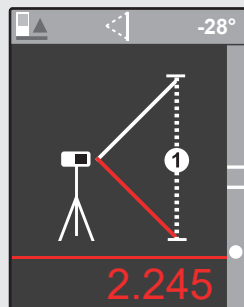
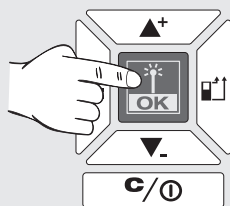

2

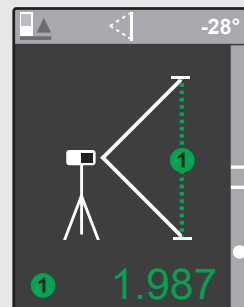
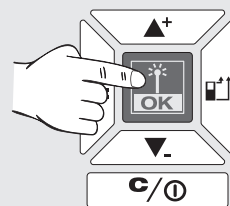

Για να μετρήσετε δύο διαφορετικά μήκη, χρησιμοποιήστε ένα στατίφ ή μια άλλη σταθερή επιφάνεια.

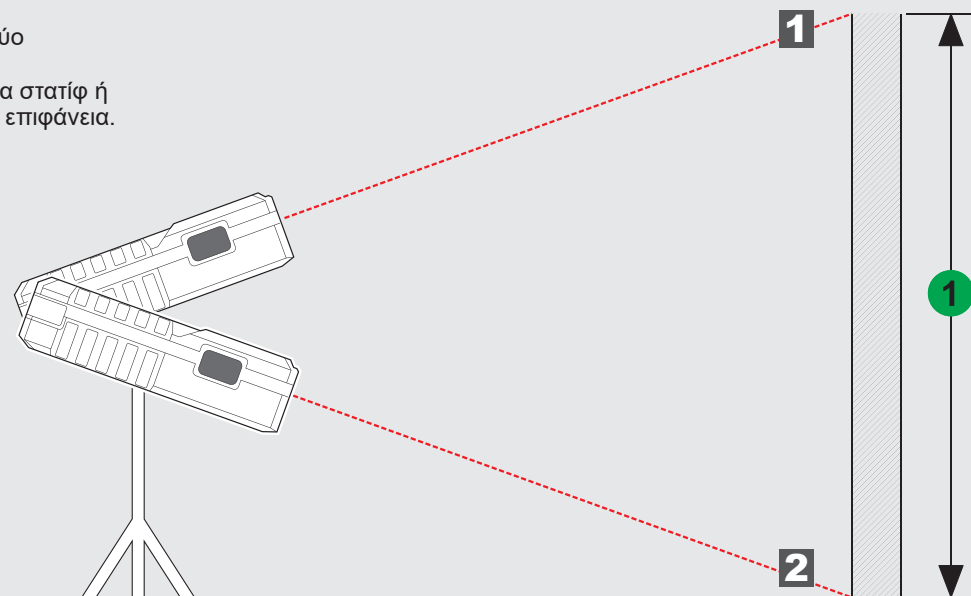

İÇİNDEKİLER

Önemli Emniyet Talimatnamesi	1
Teknik veriler.....	2
Kullanım.....	2
Hata Kodu Tablosu	2
Genel bakış	3
Ölçüm noktası.....	4
Menü.....	5
Başlatmak.....	6
Uzunluğun ölçülmesi	7
Alanın ölçülmesi	8
Toplam alanın ölçülmesi	9
Hacmin ölçülmesi	10
Dolaylı yükseklik/uzunluk ölçümü (sadece LDM 100 ile).....	11
Dolaylı yükseklik ölçümü (sadece LDM 100 ile).....	12

ÖNEMLİ EMNİYET TALIMATNAMESİ



Ürünle birlikte verilen CD'deki Emniyet talimatnamesini ve Kullanma kılavuzunu okumadan önce ürünü kullanmayın.

Lazer Sınıfı

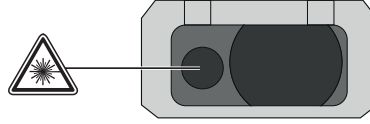

İKAZ:

Bu ürün, IEN60825-1:2014 standardına göre, **Sınıf 2** lazer kategorisine girer.



Uyarı:

Doğrudan ışına bakmayınız. Lazer ışını ışık körlüğüne yol açabilir.

Gözünüzü, gereksiz yere lazer ışınına dikmeyiniz ve bu ışınları başkalarının üzerine tutmayınız.

Diğer şahıslara yöneltmeyin.

Uyarı:

Lazer cihazını çocukların yakınında kullanmayın veya çocukların lazer cihazını kullanmalarına izin vermeyin.

Dikkat! Yansıma yapan bir yüzey lazer ışınına kullanıcıya veya başka kişilere geri yansıtabilir.

Dönen parçalarla aranızda emniyetli bir mesafe bulundurun.

Periyodik olarak denetleme ölçümleri yapın. Özellikle, önemli ölçümleri yapmadan önce, yaparken ve yaptıktan sonra.

Cihazın düşürülmesinden veya uygun olmayan alanda kullanılmasından ya da üzerinde yapılan değişiklikten kaynaklanan bir arıza sebebiyle, hatalı ölçümlerden sakınız.

Uyarı: Kumanda elemanlarının kullanılması, el kitabında tespit edilmiş yöntemlerden farklı yöntemlerin veya ayarların uygulanması tehlikeli ışınımların oluşmasına neden olabilir.

Lazerli mesafe ölçerin kullanımıyla ilgili sınırlar vardır. (Bkz. Teknik Veriler bölümü). Maksimum ve minimum aralık dışındaki ölçüm denemeleri yanlış sonuçlara neden olacaktır. Çok sıcak, çok soğuk, çok parlak güneş ışığı, yağmur, kar, sis veya diğer görüşü kısıtlayan koşullar gibi olumsuz koşullarda kullanım, yanlış ölçüm değerlerinin elde edilmesine yol açacaktır.

Lazerli mesafe ölçer çok soğuk koşullardan sıcak bir ortama getirilirse veya tam tersi bir durumda, kullanımdan önce cihaz ortam sıcaklığına gelene kadar bekleyiniz.

Lazerli mesafe ölçeri daima kapalı ortamda saklayınız, cihazı şok, sürekli titreşim veya aşırı sıcaklıklara maruz bırakmayınız.

Aleti daima toz, sıvılar ve yüksek nem koşullarından uzakta tutunuz. Bunlar, iç bileşenlere zarar verebilir veya doğruluk hassasiyetini etkileyebilir.

Aşındırıcı temizlik maddeleri veya çözeltilerini kullanmayınız. Temizlik için yalnızca temiz, yumuşak bir bez kullanınız.

Ölçüm aletinin ağır bir darbeye uğramasını veya yere düşmesini önleyiniz. Cihaz yere düşürülmüşse veya diğer mekanik gerilimlere maruz kalmışsa, kullanımdan önce aletin doğruluğu kontrol edilmelidir.

Bu lazer cihazında gerekli olan tamirler sadece yetkili servis personeli tarafından yapılabilir.

Agresif veya patlayıcı ortamlarda çalıştırmayın.



Bitmiş piller, evsel atıkla birlikte elden çıkarılmamalıdır. Çevreye karşı gereken özeni göstererek, bitmiş pilleri ulusal ya da yerel yönetmeliklere uygun olarak temin edilen atık toplama merkezlerine bırakın. Ürün, evsel atıkla birlikte elden çıkarılmamalıdır. Ürünü ülkenizde yürürlükte bulunan ulusal yönetmeliklere uygun olarak elden çıkarın. Ulusal ve spesifik yönetmeliklere göre hareket edin. Elden çıkarılmalarıyla ilgili bilgiler almak için mahalli makama veya satıcınıza başvurun.



TEKNİK VERİLER

	LDM 45	LDM 100
Alıcı Mercekler	15 mm x 9 mm	18 mm
Ölçüm aralığı		
Minimum mesafe	45 m (Tolerans: 45,1 m)	100 m (Tolerans: 101 m)
Maksimum mesafe	0,05 m	0,05 m
Mesafe ölçümü		
Tipik tolerans (% 100 hedef yansması için geçerli (beyaz boyanmış duvar), düşük arka fon aydınlatması, 25 °C)	± 2,0 mm (0,1 mm/m'lik bir ek tolerans göz önünde bulundurulmalıdır)	± 2,0 mm (0,1 mm/m'lik bir ek tolerans göz önünde bulundurulmalıdır)
Maksimum tolerans (düşük yansmalı hedefler için geçerli, yüksek arka fon aydınlatması veya üst/alt değere yaklaşan sıcaklıklar)	± 4,0 mm (0,15 mm/m'lik bir tolerans göz önünde bulundurulmalıdır)	± 4,0 mm (0,15 mm/m'lik bir tolerans göz önünde bulundurulmalıdır)
Gösterilebilen en küçük birim	1,0 mm	1,0 mm
Lazer noktası büyüklüğü		
16 m mesafe:	25 x 50 mm	25 x 50 mm
Lazer sınıfı	2	2
Lazer tipi	635 nm, < 1 mW	635 nm, < 1 mW
Düşey Açısı		
Düşey Açısı	+1 derece	+1 derece
Yatay Açısı	±1 derece	±1 derece
Ekran Tipi	LCD (22.7 mm x 25 mm)	LCD (22.7 mm x 25 mm)
Lazerin otomatik kapanma süresi	90 saniye	90 saniye
Cihazın otomatik kapanma süresi	180 saniye	180 saniye
Güç Türü	AAA 2x (Kalem Pil)	AAA 2x (Kalem Pil)
Pil Ömrü	8000 (Münferit Ölçüm)	8000 (Münferit Ölçüm)
Çalışma Sıcaklığı Aralığı	-0°C ila +40°C	-0°C ila +40°C
Saklama Sıcaklığı Aralığı	-10°C ila +60°C	-10°C ila +60°C
Pilsiz Ağırlığı	87 g	122 g
Toz ve Su direnci	IP54	IP54

KULLANIM

Lazerli mesafe ölçer, uzaklıklar ve eğimlerin ölçümü için kullanılabilir.

Bu alet sadece belirttiği gibi ve usulüne uygun olarak kullanılabilir.

HATA KODU TABLOSU

Kod	Tanım	Çözüm
Err500	Donanım problemleri	Ölçüm cihazını kapatın ve tekrar çalıştırınız. Problem devam ettiğinde ölçüm cihazını en yakın servis merkezine götürünüz.

GENEL BAKIŞ

DURUM ÇUBUĞU

- ▶ Referans ölçme noktası, ölçüm türü, ölçüm açısı (sadece LDM 100 ile), ölçme düzeyi (sadece LDM 100 ile)

EKRAN

- ▶ Menü
- ▶ Ölçümler
- ▶ Ayarlar

YUKARIYA / TOPLA

- ▶ Menüde yukarı git
- ▶ Değeri topla

ÖLÇÜM / OK

- ▶ Lazeri çalıştır
- ▶ Ölçüm değerini kaydet
- ▶ Menüde OK seçiniz

MENÜ

- ▶ Seyir
- ▶ Ölçüm
- ▶ Ayarlar

AŞAĞI / ÇIKART

- ▶ Menüde aşağı git
- ▶ Değeri çıkart

SİL / AÇMAK/KAPATMAK

- ▶ AÇ / KAPAT (cihaz sinyal sesi verene kadar tuşu basılı tutunuz)
- ▶ Ölçüm değerini sil

ÖLÇÜM NOKTASI

- ▶ Arka (standart ayar)
- ▶ Ön
- ▶ Köşe (otomatik olarak pimin dışarı açılmasıyla etkinleştirilmektedir)

ÖLÇMEK

- ▶ Lazeri çalıştır
- ▶ Ölçüm değerini kaydet

PİLLERİ DEĞİŞTİR

- ▶ Pil sembolü yanıp söndüğünde pilleri değiştiriniz

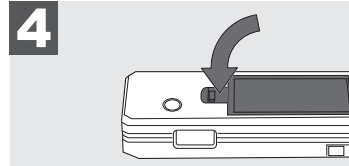
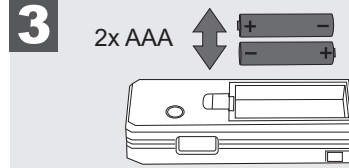
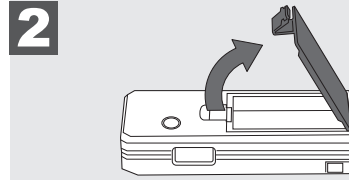
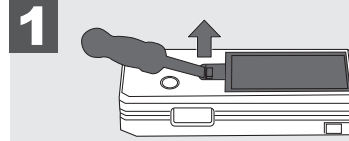

SEHPA

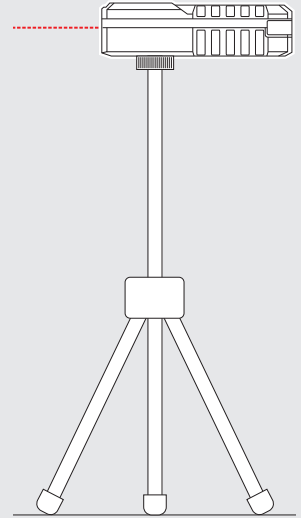

KÖŞE PİMİ

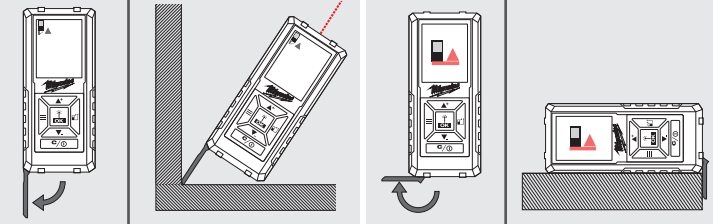

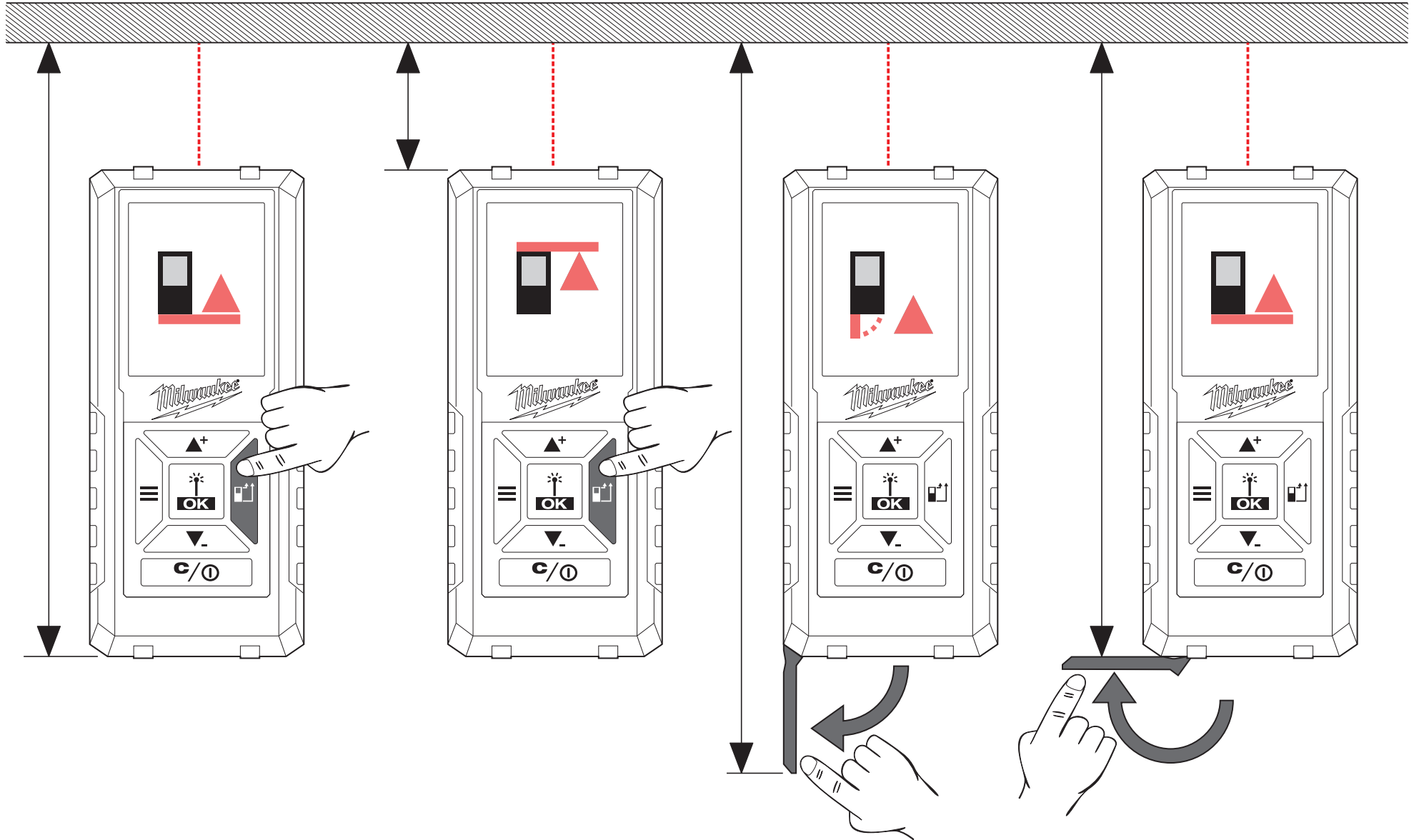

MENÜ

SEYİR

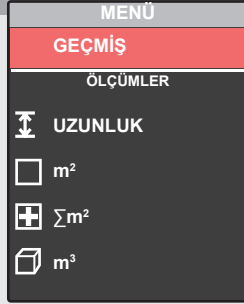

Son 30 ölçümün/hesaplamaların gösterilmesi.
Yüzey, toplam alan, hacim vs. hesaplanması için somut ölçümler SEYİR kısmında kaydedilmez, sadece hesapların sonucu kaydedilir.
Bir kaydı silmek için C/AÇ/KAPAT tuşuna basınız.

SEYİR kısmında kaydedilmiş değerlere ölçümleri/hesapları ekleyebilir veya bunlardan çıkartabilirsiniz. Sadece aynı türden hesaplar yapılabilir (uzunluk, alan, hacim vs.).

Bir hesabın yapılması:

1. SEYİR kısmından bir ölçüm modu seçmek için ▲+ ▼ tuşları kullanınız.
2. OK tuşuna basınız.
3. Hesap için gerekli ölçümleri yapınız.
4. Yeni hesabı SEYİR kısmına kaydetmek için OK tuşuna basınız.

ÖLÇÜM

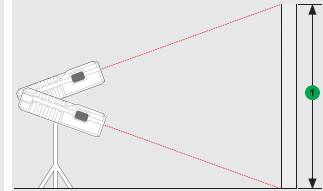
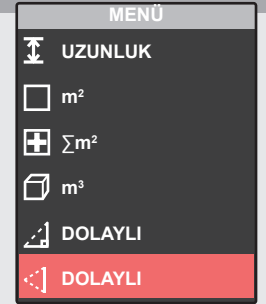
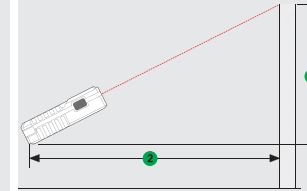
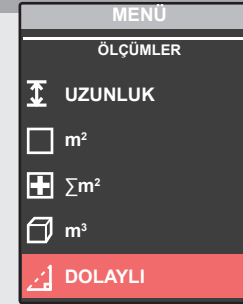
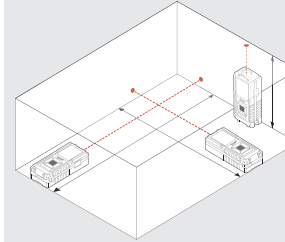
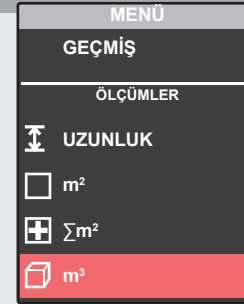
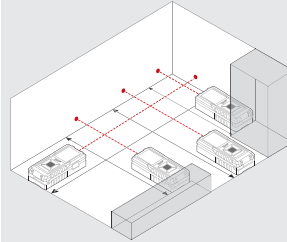
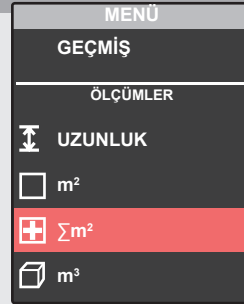
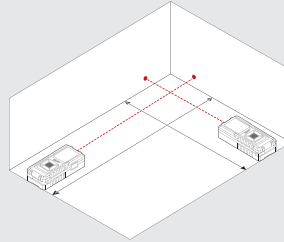
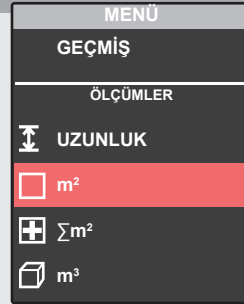
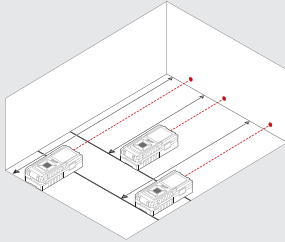
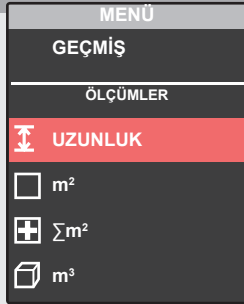

AYARLAR

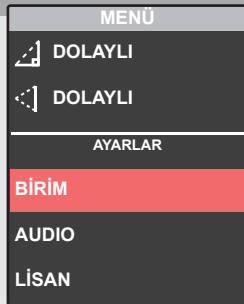

İstenilen birimi seçiniz.

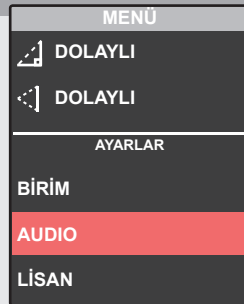

Sinyal sesi açık/kapalı.

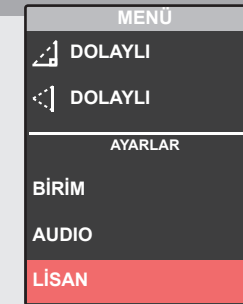

Lisansı seçiniz.

BAŞLATMAK

1

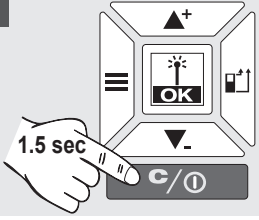

2

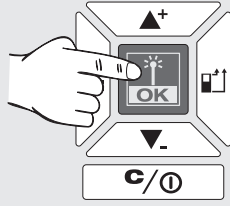

3

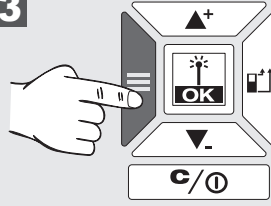

4

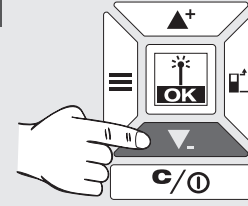

5

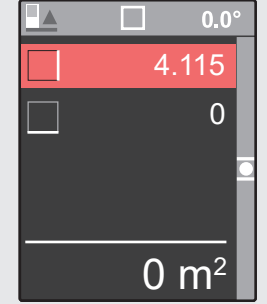
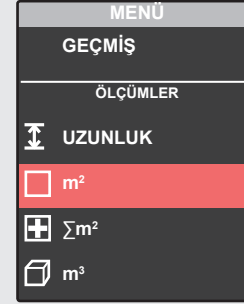
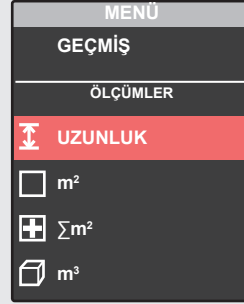
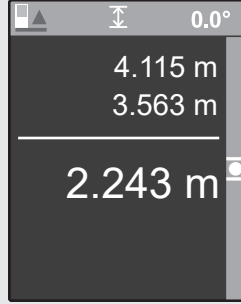
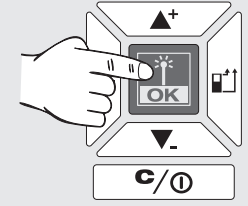

Çalıştırdıktan sonra UZUNLUK ÖLÇÜM MODU otomatik olarak etkinleştirilmektedir.

Bir UZUNLUK ÖLÇÜMÜ yapınız veya ...

... menüye geçmek için menü tuşuna basınız ...

ve ▲+ ▼- tuşları yardımıyla başka bir işletim türü seçiniz ...

ve bu işletim türünü OK tuşuna basarak etkinleştiriniz.

UZUNLUGUN ÖLÇÜLMESİ

0



Ölçüm değeri beyaz = değer ölçüldü

1

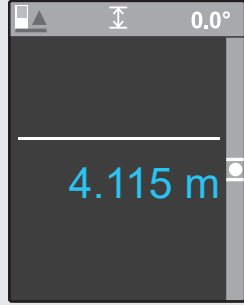
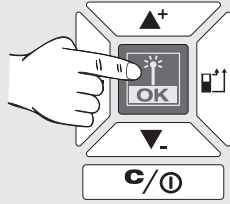

Ölçüm değeri mavi = değer ara belleğe kaydedildi

2

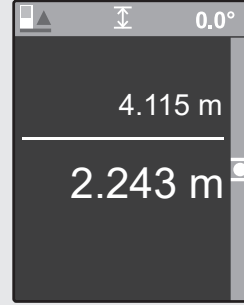
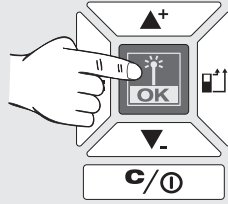

3

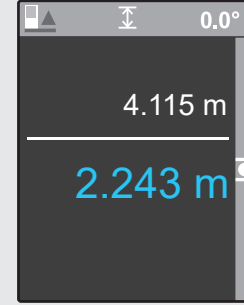
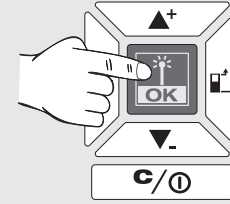

4

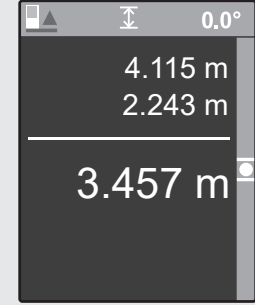
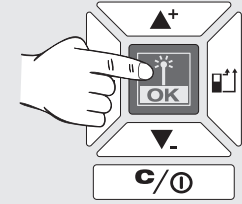

5

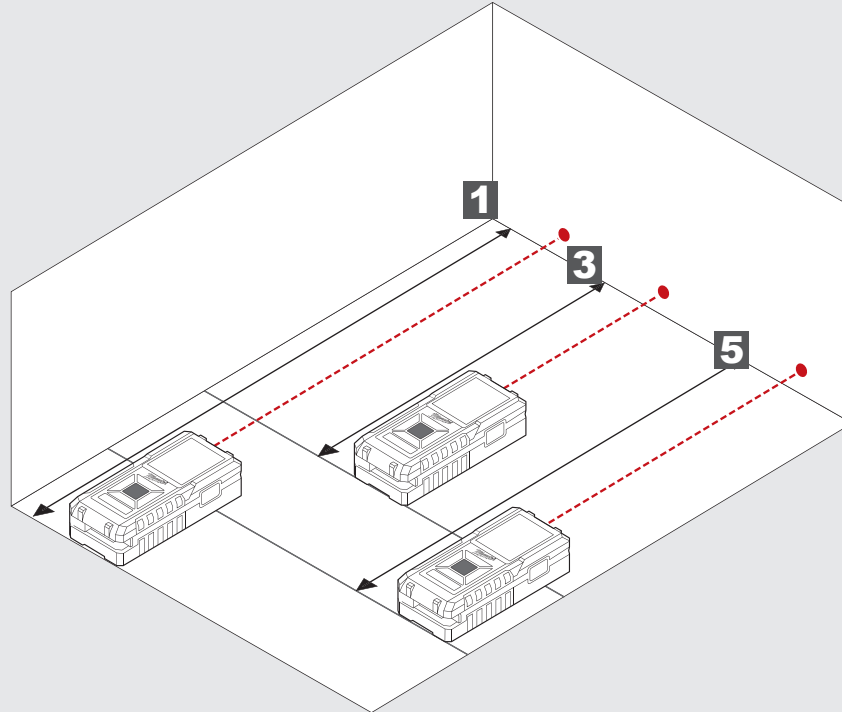
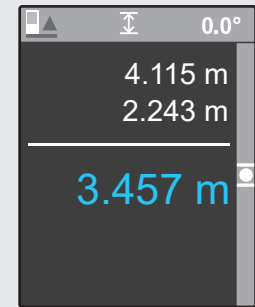
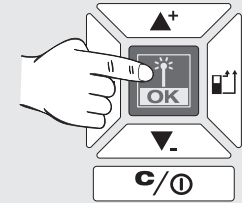

ALANIN ÖLÇÜLMESİ

0

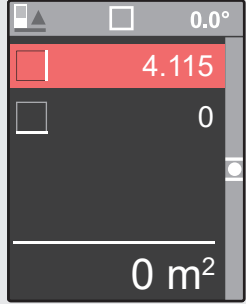

1

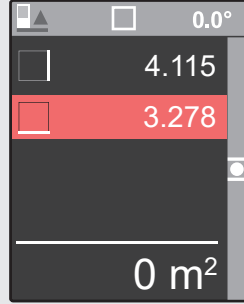
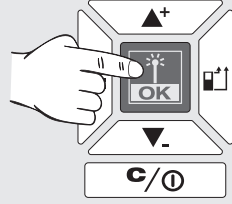

2

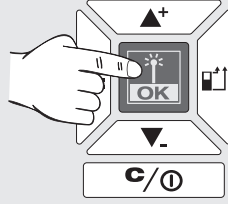

2

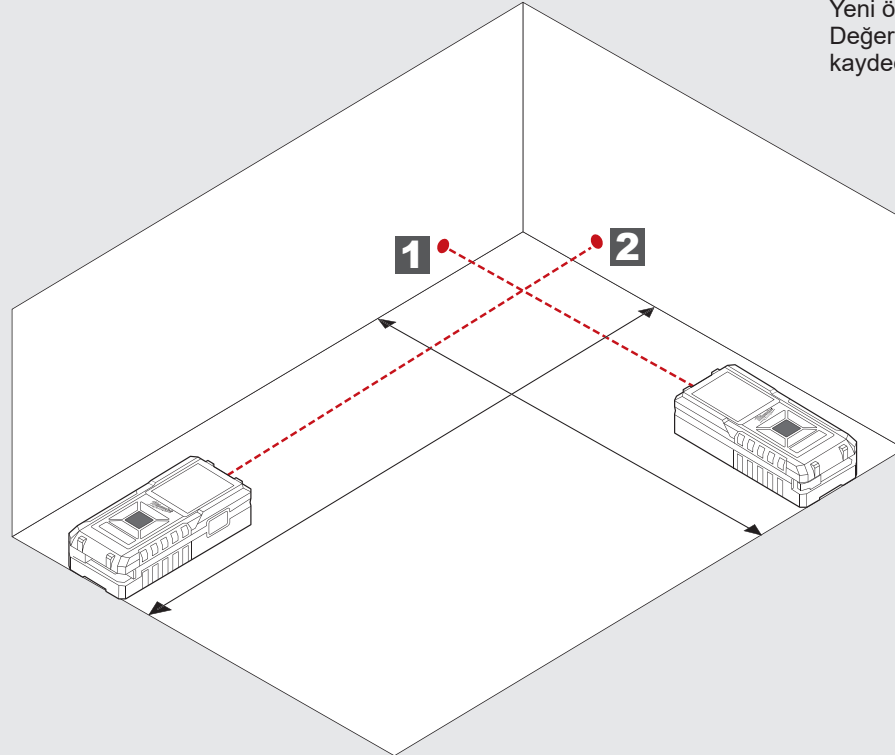
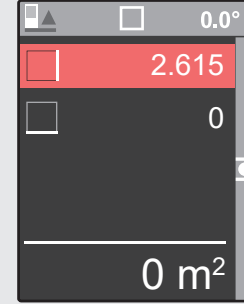
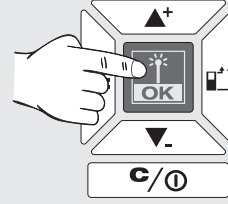

Yeni ölçüm.
Değer SEYİR kısmına
kaydedilmektedir.

TOPLAM ALANIN ÖLÇÜLMESİ

0

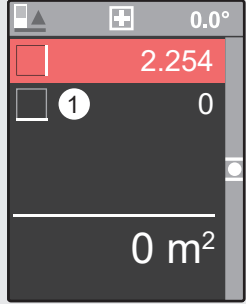

1

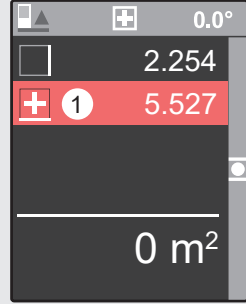
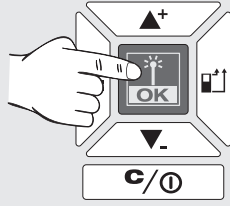

2

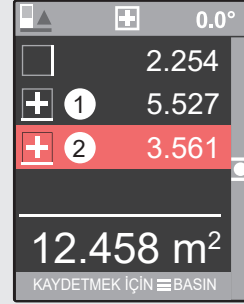
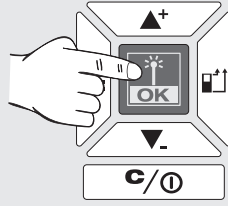

3

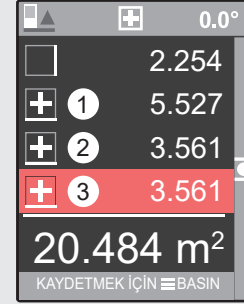
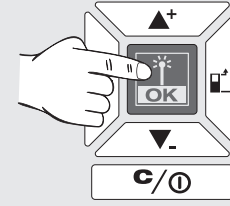

4

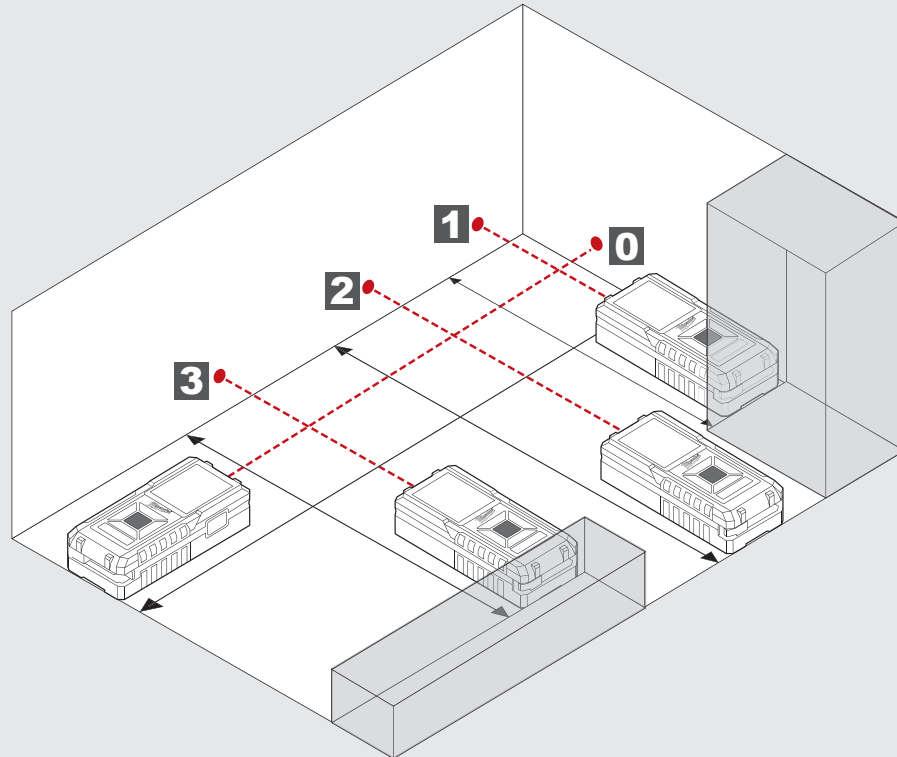
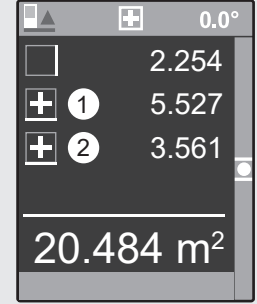
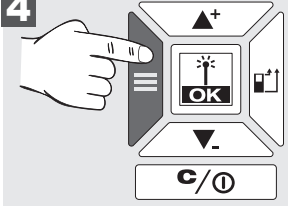

4

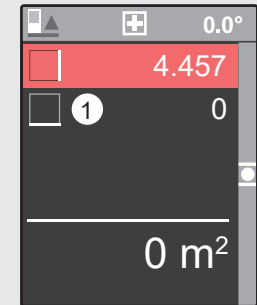
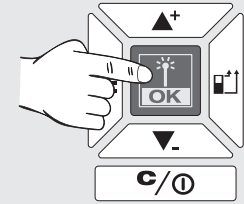

Yeni ölçüm.
Sonuç SEYİR kısmında
kaydedilmektedir.

HACMIN ÖLÇÜLMESİ

0

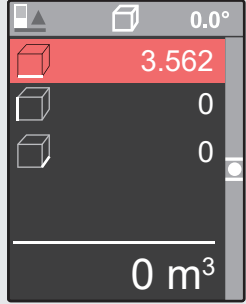

1

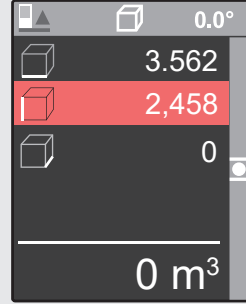
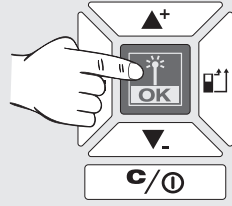

2

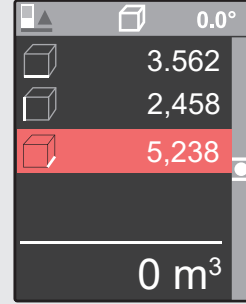
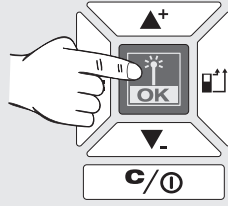

3

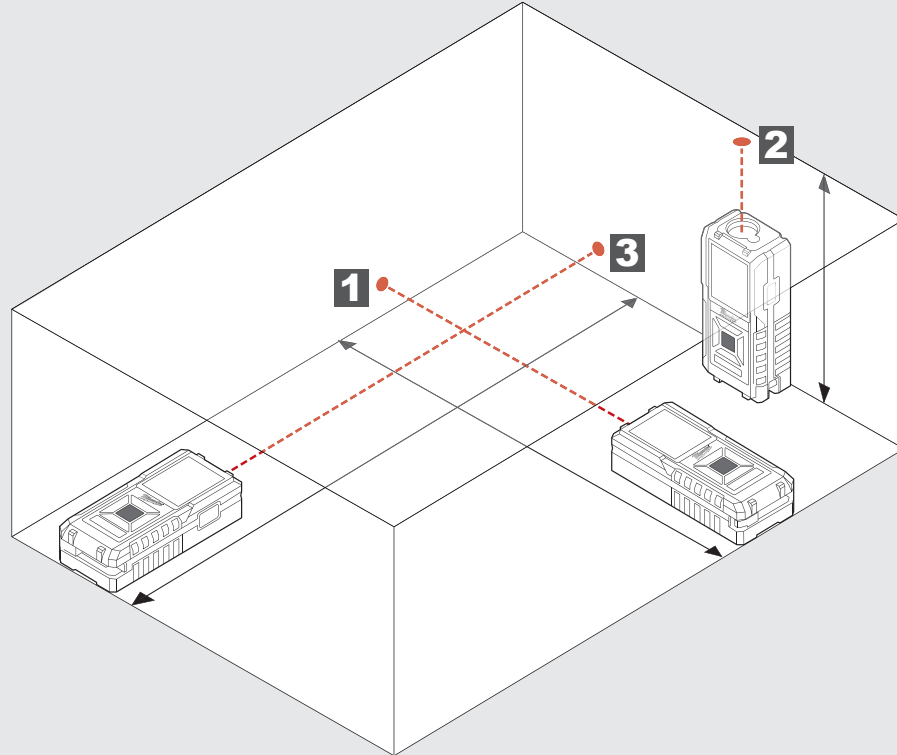
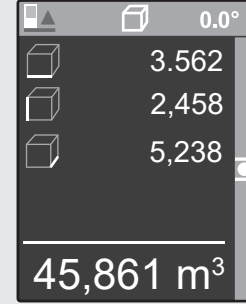
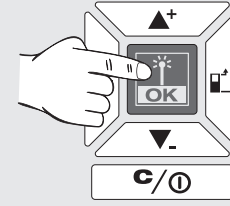

DOLAYLI YÜKSEKLİK/UZUNLUK ÖLÇÜMÜ (SADECE LDM 100 İLE)

0

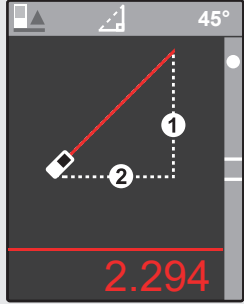

1

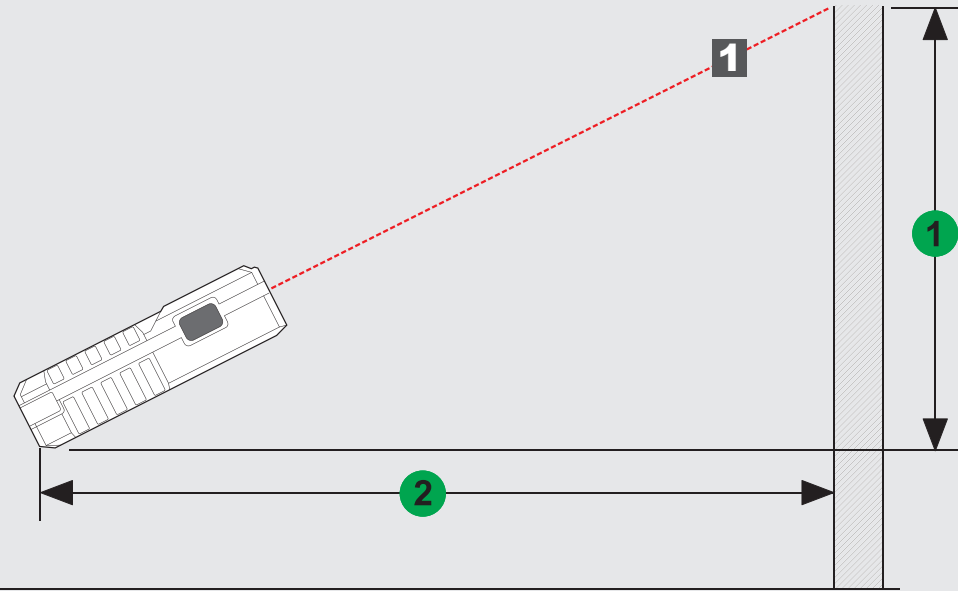
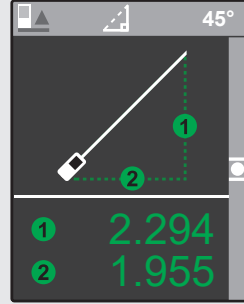
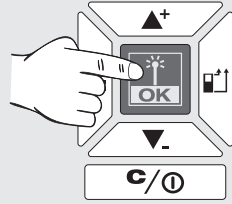

DOLAYLI YÜKSEKLİK ÖLÇÜMÜ (SADECE LDM 100 İLE)

0

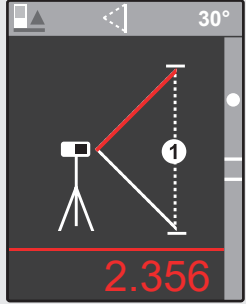

1

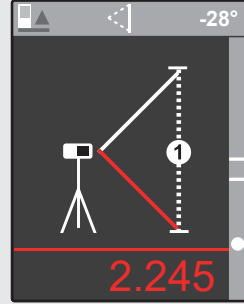
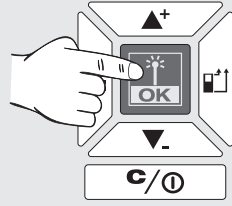

2

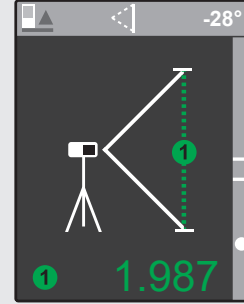
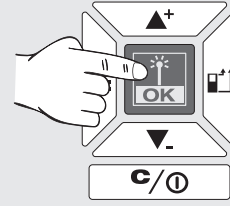

İki farklı uzunluğu ölçmek için
bir sehpa veya başka bir
sağlam yüzey kullanınız.

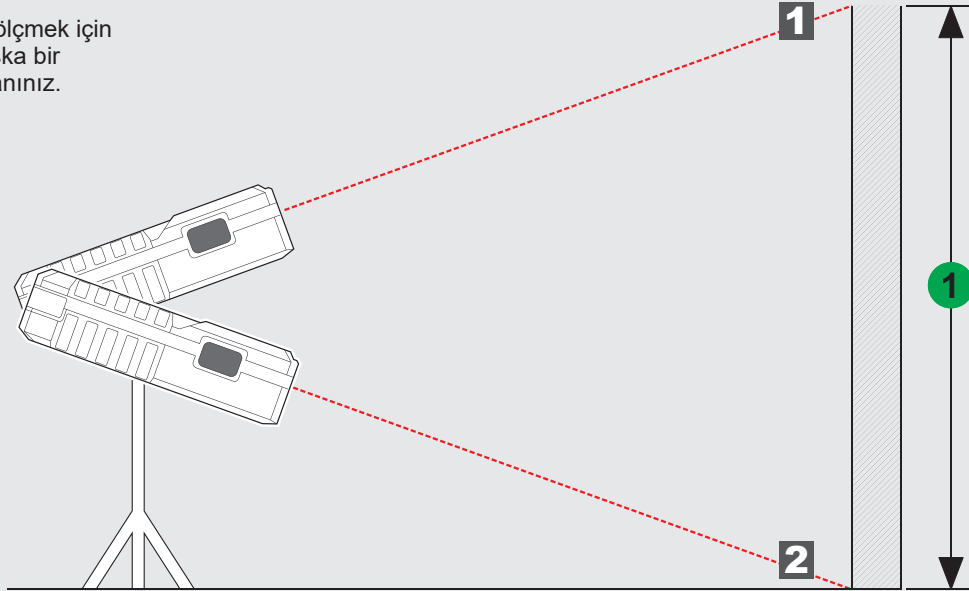

OBSAH

Důležité bezpečnostní pokyny.....	1
Technická data	2
Oblast Využití	2
Tabulka chybových kódů	2
Přehled	3
Měřicí bod.....	4
Menu.....	5
Spuštění	6
Měření délky	7
Měření plochy	8
Měření celé plochy	9
Měření objemu.....	10
Nepřímé měření výšky/délky (pouze s LDM 100).....	11
Nepřímé měření výšky (pouze s LDM 100).....	12

DŮLEŽITÉ BEZPEČNOSTNÍ POKYNY



Než začnete výrobek používat, prostudujte si bezpečnostní pokyny a návod k obsluze na přiloženém CD.

Klasifikace laseru

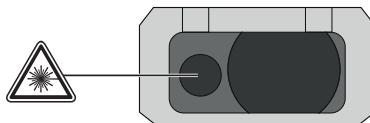

UPOZORNĚNÍ:

Jedná se o laserový výrobek **třídy 2** podle normy EN60825-1:2014 .



Výstraha:

Vyhňte se přímému kontaktu s očima. Laserový paprsek může poškodit oči zábleskem a vést ke krátkodobému oslepení.

Nedívejte se přímo do laserového paprsku ani jej nesměřujte zbytečně na jiné osoby.

Neoslňujte jiné osoby.

Výstraha:

Laserový přístroj neprovozujte v blízkosti dětí a dětem nedovolte, aby laserový přístroj používaly.

Pozor! Reflexní povrch by mohl laserový paprsek odrazit zpět na obsluhu nebo jiné osoby.

Udržujte bezpečnou vzdálenost končetin od pohyblivých součástí.

Provádějte pravidelná zkušební měření. Zejména před důležitými měřeními, během nich a po nich.

Dávejte pozor na chybná měření, jestliže je výrobek vadný nebo pokud byl upuštěn či nesprávně používán nebo upravován.

Výstraha: Použití ovládacích prvků, nastavení nebo zrealizování jiných postupů než bylo stanoveno v příručce může vést k nebezpečnému ozáření.

Laserový měřicí přístroj má omezenou oblast použití. (Viz odstavce Technické údaje). Pokusy měřit mimo maximální a minimální rozsah způsobí nepřesnosti. Použití přístroje za nepříznivých podmínek, jako je příliš vysoká a příliš nízká teplota, velmi ostré sluneční světlo, déšť, sníh, mlha nebo jiné podmínky omezující viditelnost, může vést k nepřesným měřením.

Pokud bude přístroj přenesený z teplého prostředí do studeného prostředí (nebo naopak), musíte počkat, až se přístroj přizpůsobí nové teplotě okolního prostředí.

Laserový měřicí přístroj vždy uskladňujte v místnosti, přístroj chraňte před otřesy, vibracemi a extrémními teplotami.

Laserový měřicí přístroj chraňte před prachem, mokřím prostředím a vysokou vzdušnou vlhkostí. Tyto vlivy mohou zničit vnitřní součástky nebo ovlivnit přesnost měření.

Nepoužívejte žádné agresivní čisticí prostředky nebo rozpouštědla. Čistěte jen čistým měkkým hadříkem.

Vyhňte se silným úderům do přístroje nebo pádu laserového měřicího přístroje. Přesnost přístroje by se měla zkontrolovat tehdy, jestliže přístroj spadl nebo byl vystaven jinému mechanickému zatížení.

Potřebné opravy na tomto laserovém přístroji smí realizovat jen autorizovaný odborný personál.

Nepoužívejte výrobek v prostorách s nebezpečím výbuchu nebo v agresivním prostředí.

 Vybité baterie nesmí být likvidovány jako komunální odpad. Pečujte o životní prostředí a baterie odevzdejte na sběrných místech ustanovených v souladu s národními nebo místními předpisy. Výrobek nevhazujte do komunálního odpadu. Výrobek patřičně zlikvidujte v souladu s národními předpisy platnými ve vaší zemi. Dodržujte národní předpisy a doporučení. Ohledně získání informací o likvidaci se obraťte na místní úřady nebo na vašeho prodejce.

 Značka CE

TECHNICKÁ DATA

	LDM 45	LDM 100
Optika	15 mm x 9 mm	18 mm
Rozsah měření		
Minimální vzdálenost	45 m (Tolerance: 45,1 m)	100 m (Tolerance: 101 m)
Maximální vzdálenost	0,05 m	0,05 m
Měření vzdálenosti		
Typická tolerance (platí pro 100 % časovou reflexi (bíle lakovaná stěna), nepatrné osvětlení pozadí, 25 °C)	± 2,0 mm (dodatečná tolerance 0,1 mm/m by se měla zohlednit)	± 2,0 mm (dodatečná tolerance 0,1 mm/m by se měla zohlednit)
Maximální tolerance (platí pro cíle nižší frekvence, vysokého osvětlení pozadí nebo teplot, které se přibližují dolní/horní hodnotě)	± 4,0 mm (měla by se zohlednit dodatečná tolerance 0,15 mm/m)	± 4,0 mm (měla by se zohlednit dodatečná tolerance 0,15 mm/m)
Nejmenší zobrazitelná jednotka	1,0 mm	1,0 mm
Velikost laserového bodu		
Vzdálenost 16 m	25 x 50 mm	25 x 50 mm
Třída laseru	2	2
Typ laseru	635 nm, < 1 mW	635 nm, < 1 mW
Laserový paprsek		
vertikální úhel	+1 stupeň	+1 stupeň
horizontální úhel	±1 stupeň	±1 stupeň
Typ displeje	LCD (31,5 mm x 40 mm)	LCD (31,5 mm x 40 mm)
Automatické vypnutí laseru	90 sekund	90 sekund
Automatické vypnutí přístroje	180 sekund	180 sekund
Napájení	AAA 2x (alkalické baterie)	AAA 2x (alkalické baterie)
Životnost baterií	8000 (jednotlivých měření)	8000 (jednotlivých měření)
Rozsah provozní teploty	-0°C do +40°C	-0°C do +40°C
Rozsah teploty na uskladnění přístroje	-10°C do +60°C	-10°C do +60°C
Hmotnost bez baterií	87 g	122 g
Třída ochrany	IP54 (chráněný proti prachu a stříkající vodě)	IP54 (chráněný proti prachu a stříkající vodě)

OBLAST VYUŽITÍ

Laserový měřicí přístroj je vhodný na měření vzdáleností a sklonů.
Toto zařízení lze používat jen pro uvedený účel.

TABULKA CHYBOVÝCH KÓDŮ

Kód	Popis	Řešení
Err500	Problémy s hardware	Vypněte měřicí přístroj a znovu jej zapněte. Pokud problém dále existuje, doneste měřicí přístroj na níže uvedené servisní středisko.

PŘEHLED

STAVOVÁ LIŠTA

- ▶ Referenční měřicí bod, druh měření, měřicí úhel (pouze s LDM 100), úroveň měření (pouze s LDM 100)

DISPLEJ

- ▶ Menu
- ▶ Měření
- ▶ Nastavení

NAHORU/PŘIPOČÍTAT

- ▶ Jít v menu nahoru
- ▶ Připočítat hodnotu

MĚŘENÍ/OK

- ▶ Zapnout laser
- ▶ Uložit naměřenou hodnotu
- ▶ Zvolit v menu OK

MENU

- ▶ Průběh
- ▶ Měření
- ▶ Nastavení

DOLŮ/ODPOČÍTAT

- ▶ Jít v menu dolů
- ▶ Hodnotu odpočítat

VYMAZAT/ZAPNOUT/VYPNOUT

- ▶ ZAP/VYP (tlačítko podržet stisknuté, až přístroj vydá signální tón)
- ▶ Vymazat naměřenou hodnotu

MĚŘICÍ BOD

- ▶ Vzadu (standardní nastavení)
- ▶ Vpředu
- ▶ Roh (automaticky se aktivuje vyklopením tužky)

MĚŘENÍ

- ▶ Zapnout laser
- ▶ Uložit naměřenou hodnotu

VYMĚNIT BATERIE

- ▶ Vyměnit baterie, když bliká symbol baterie.

1

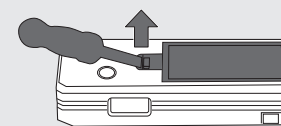

2

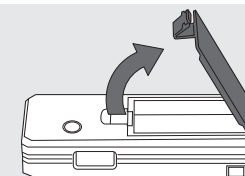

3

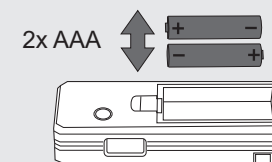

4

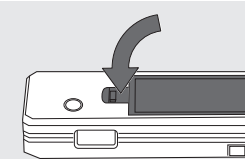

STATIV

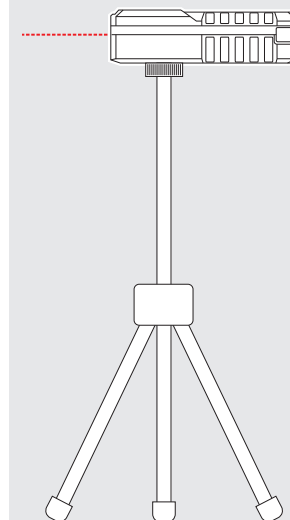

ROHOVÁ TUŽKA

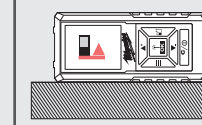
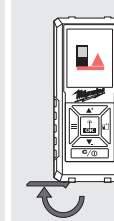
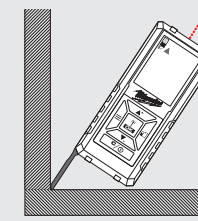

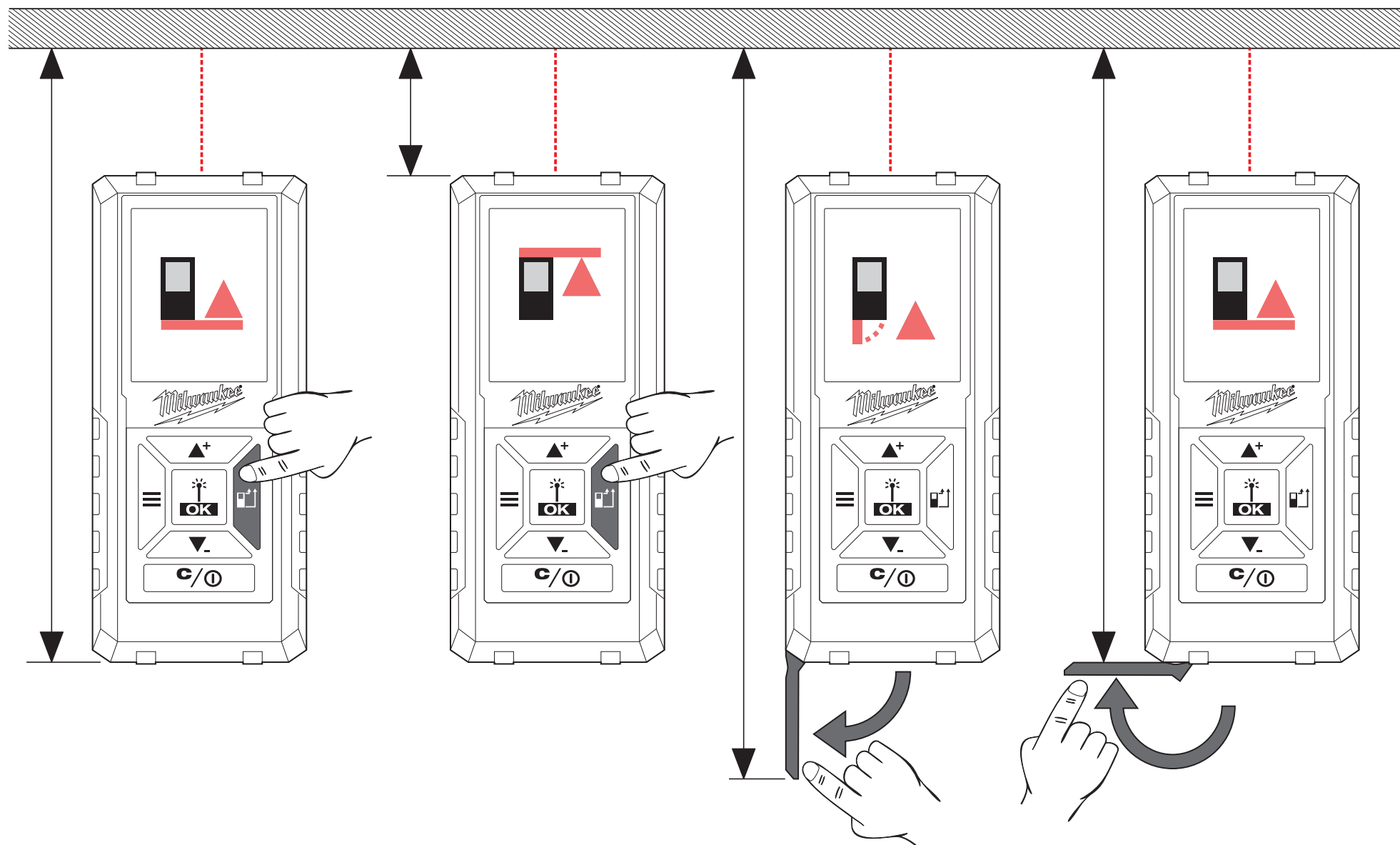

MENU

PRŮBĚH



Zobrazení posledních 30 měření/výpočtů.
Jednotlivá měření na výpočet povrchu, celkového povrchu, objemu atd. se neuloží pod PRŮBĚH, ale pouze jako výsledek výpočtů.
Na vymazání záznamu stiskněte tlačítko C/ ZAP/VYP.

K hodnotám uloženým pod PRŮBĚH se mohou měření/výpočty připočítat nebo odečíst. Mohou se provést pouze výpočty stejného druhu (délka, plocha, objem, atd.).

Provedení výpočtu:

1. Stiskněte tlačítka ▲+ ▼, abyste zvolili měřicí režim z PRŮBĚH.
2. Stiskněte tlačítko OK.
3. Proveďte měření potřebná pro výpočet.
4. Stiskněte tlačítko OK, abyste uložili nový výpočet v PRŮBĚH.

MĚŘENÍ

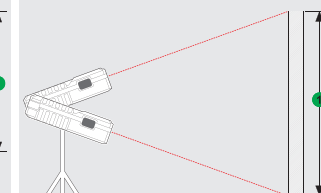
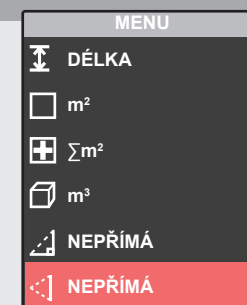
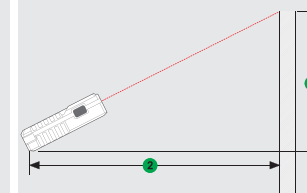
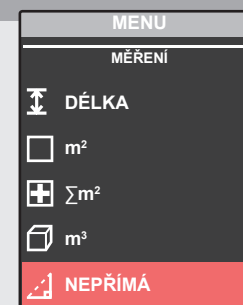
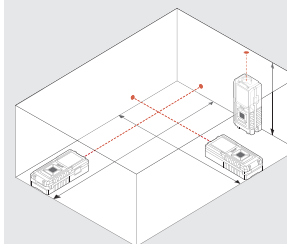
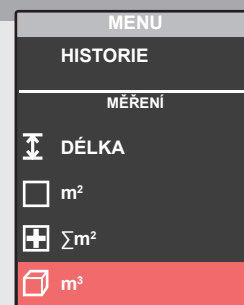
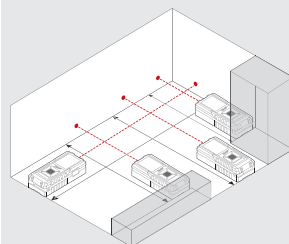
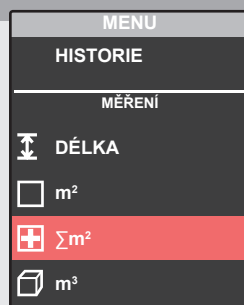
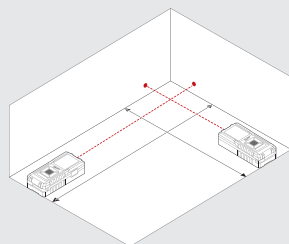
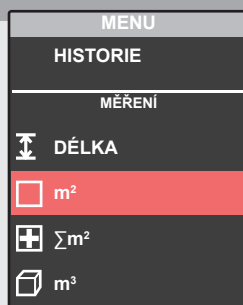
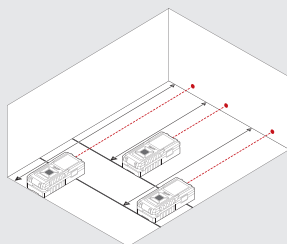
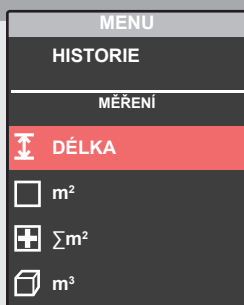

NASTAVENÍ



Zvolte požadovanou rozměrovou jednotku.





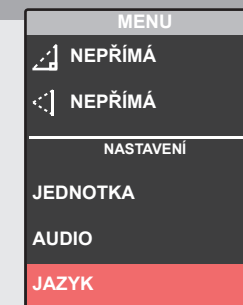

Signální tón zap/vyp.

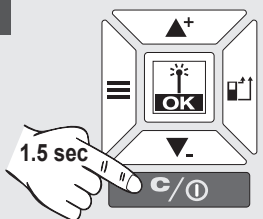
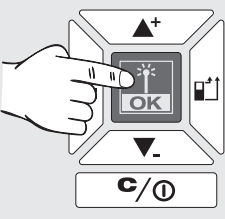
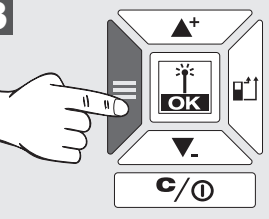
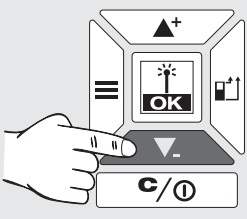
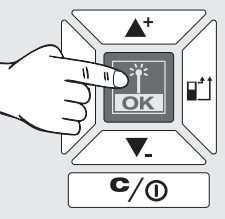

Zvolte jazyk.

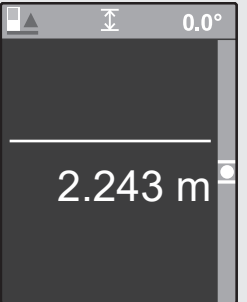
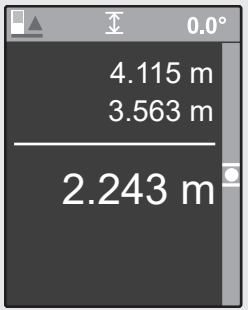
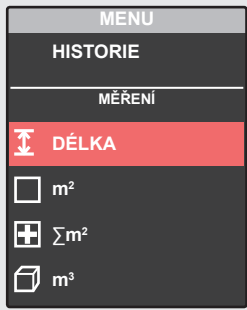
SPUŠTĚNÍ

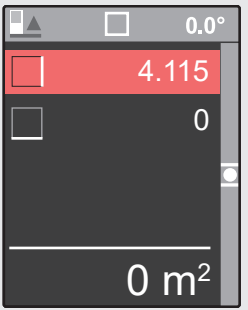
<p>1</p>  <p>1.5 sec</p>	<p>2</p> 	<p>3</p> 	<p>4</p> 	<p>5</p> 
 				
<p>Po zapnutí se automaticky aktivuje REŽIM MĚŘENÍ DÉLEK.</p>	<p>Provedte MĚŘENÍ DÉLKY nebo ...</p>	<p>... stiskněte tlačítko menu, abyste změnili na menu ...</p>	<p>... a zvolte jiný provozní režim pomocí tlačítek ▲+ ▼- a ...</p>	<p>... a aktivujte tento provozní režim stisknutím tlačítka OK.</p>

MĚŘENÍ DÉLKY

0

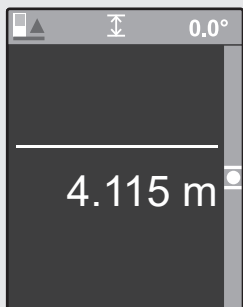

Naměřená hodnota bílá = Hodnota se měří

1

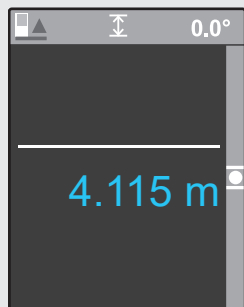
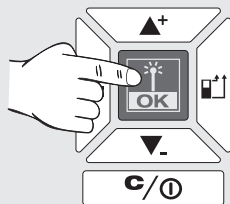

Naměřená hodnota modrá = Hodnota se dočasně uloží

2

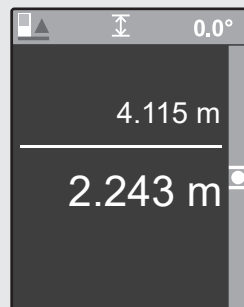
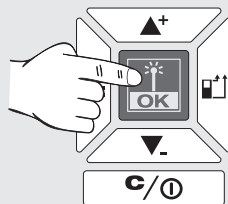

3

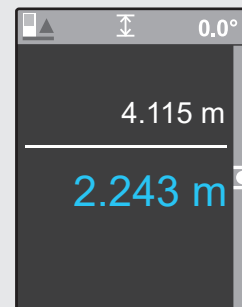
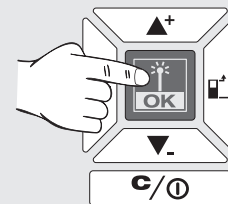

4

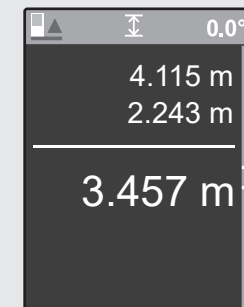
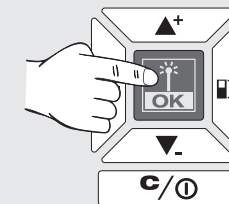

5

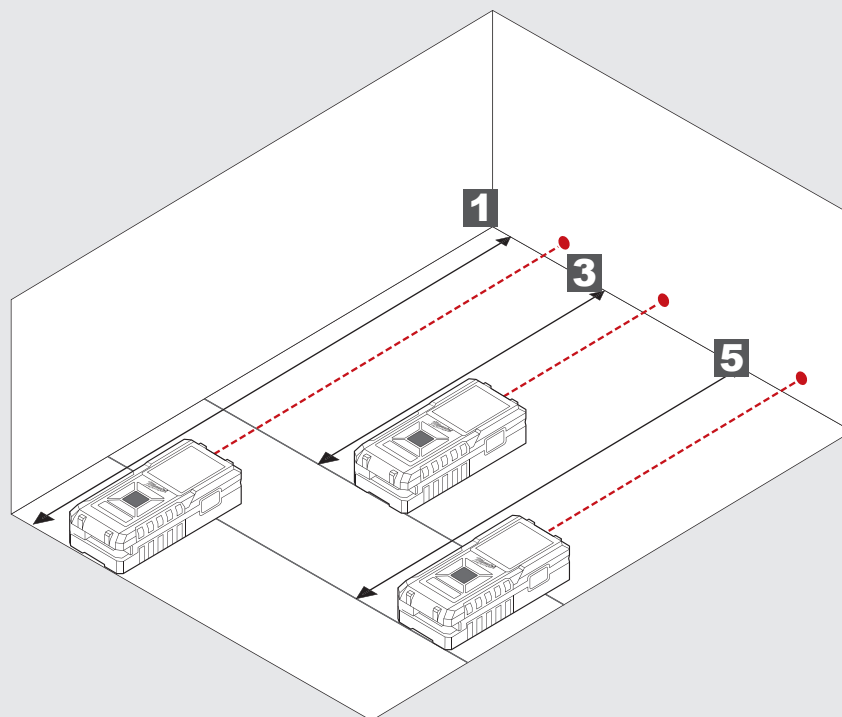
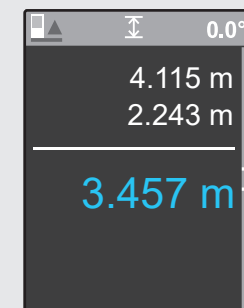
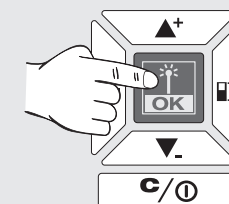

MĚŘENÍ PLOCHY

0

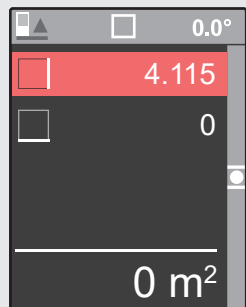

1

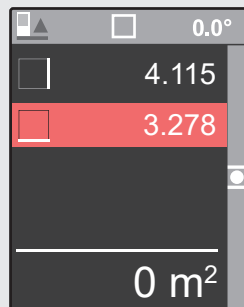
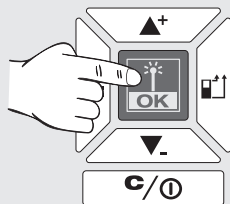

2

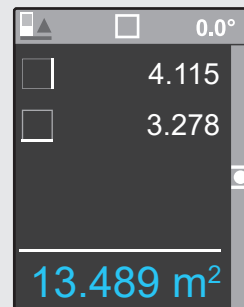
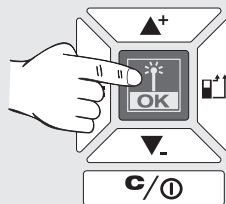

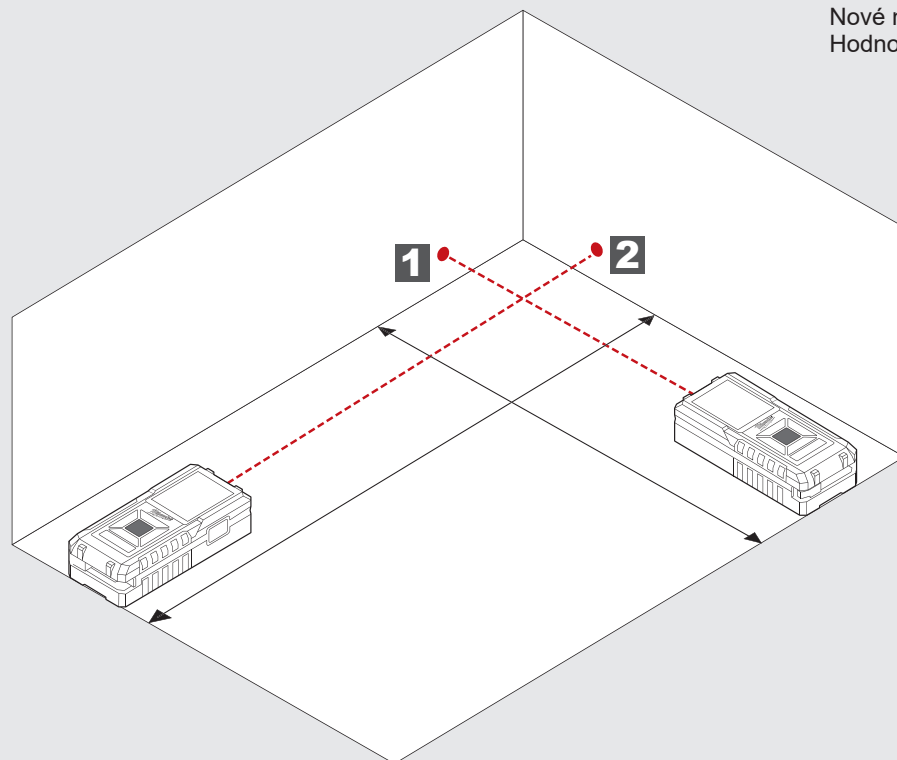
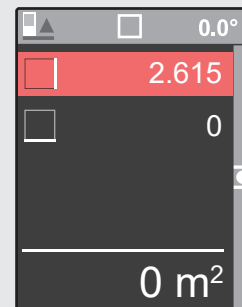
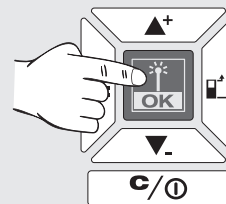

2

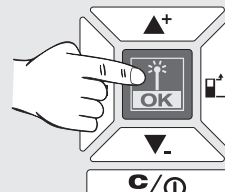
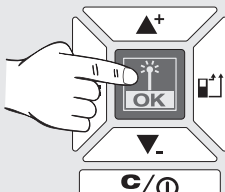
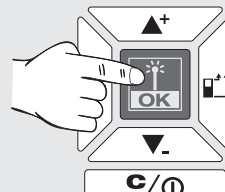
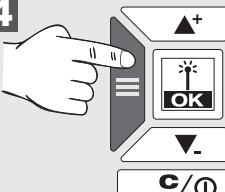

Nové měření.
Hodnota se uloží pod PRŮBĚH.

MĚŘENÍ CELE PLOCHY

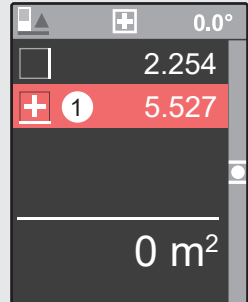
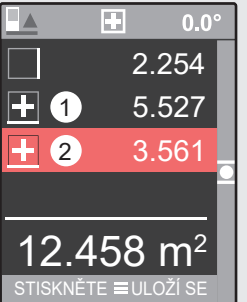
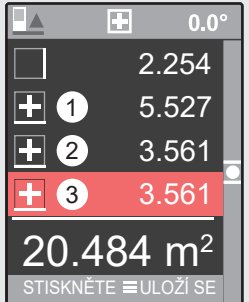
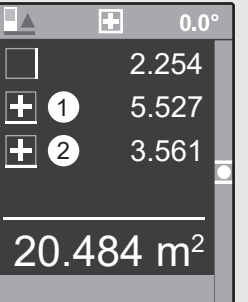
0	1 	2 	3 	4 
				

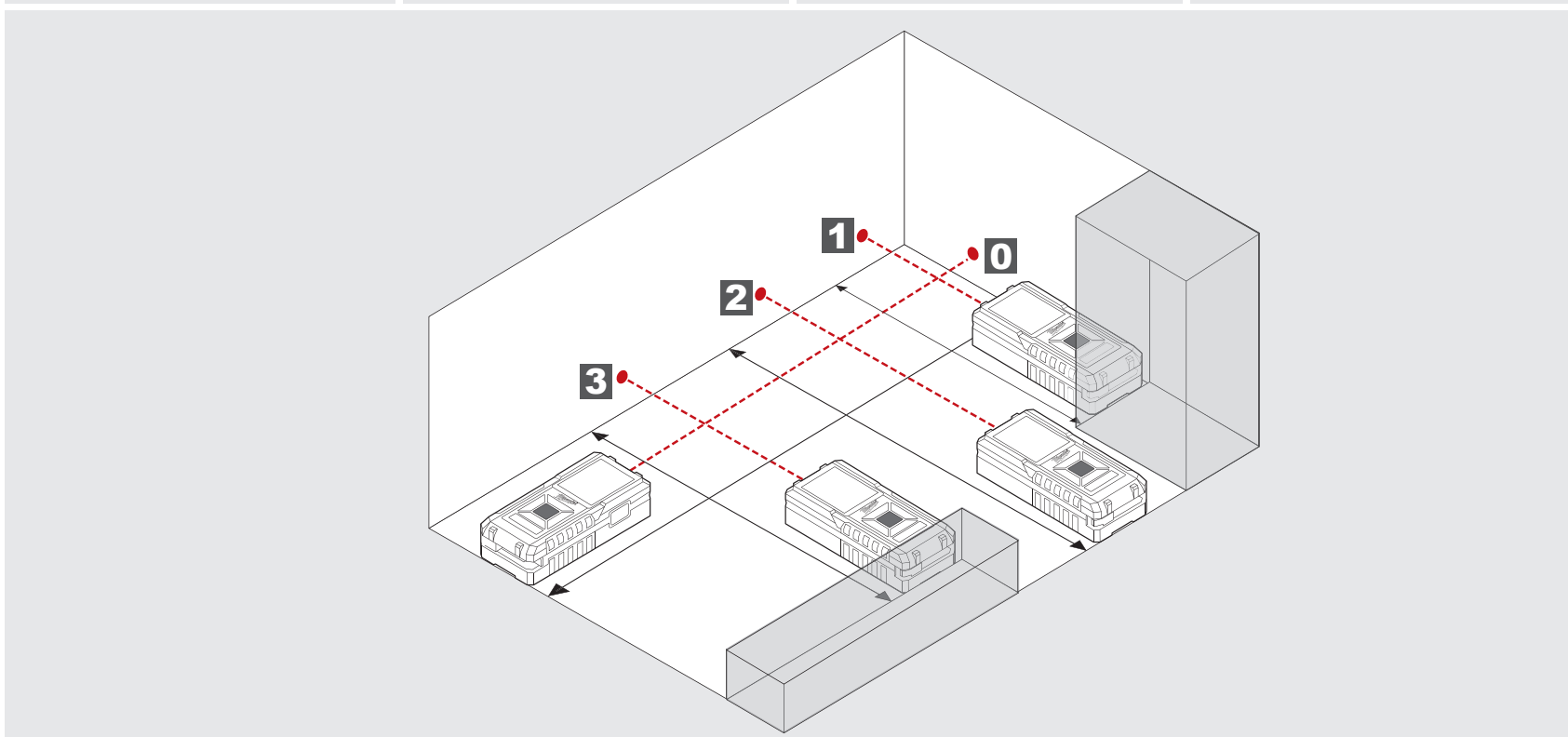

4





Nové měření.
Výsledek se uloží pod PRŮBĚH.

MĚŘENÍ OBJEMU

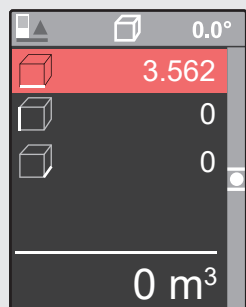
0

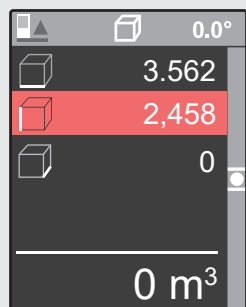
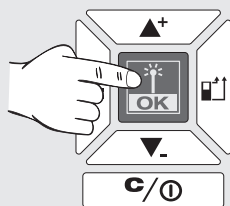

1



2

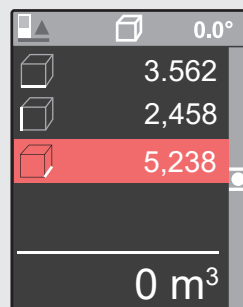
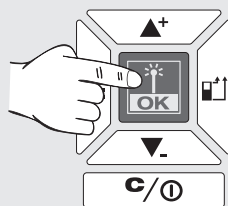

3

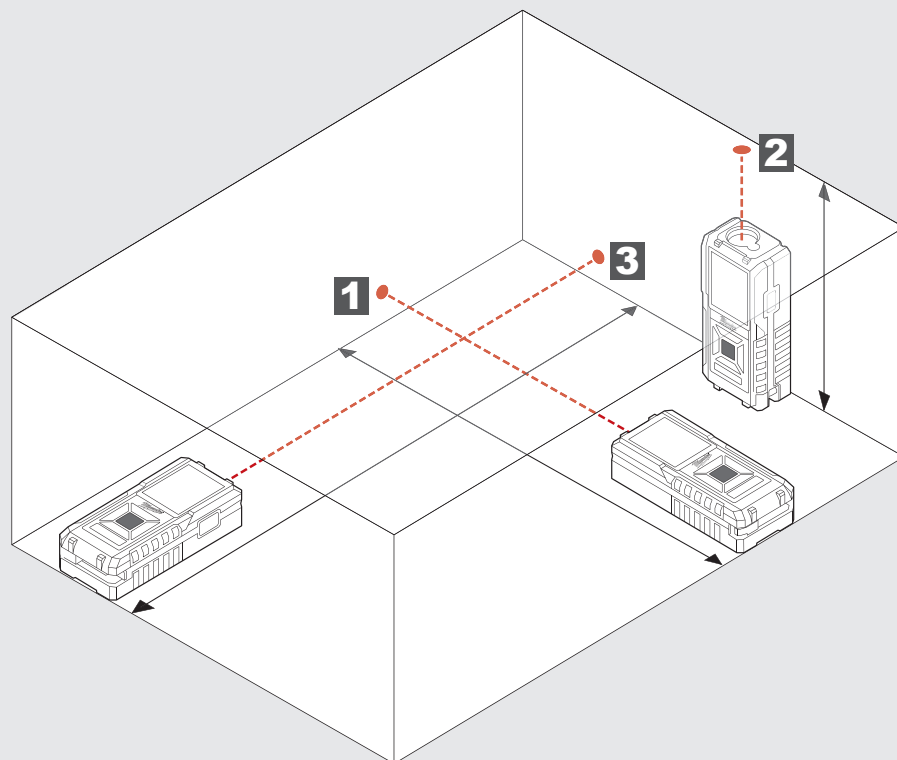
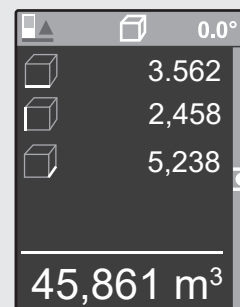
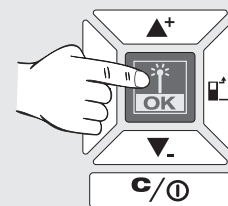

NEPŘÍMÉ MĚŘENÍ VÝŠKY/DĚLKY (POUZE S LDM 100)

0

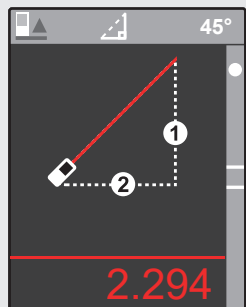

1

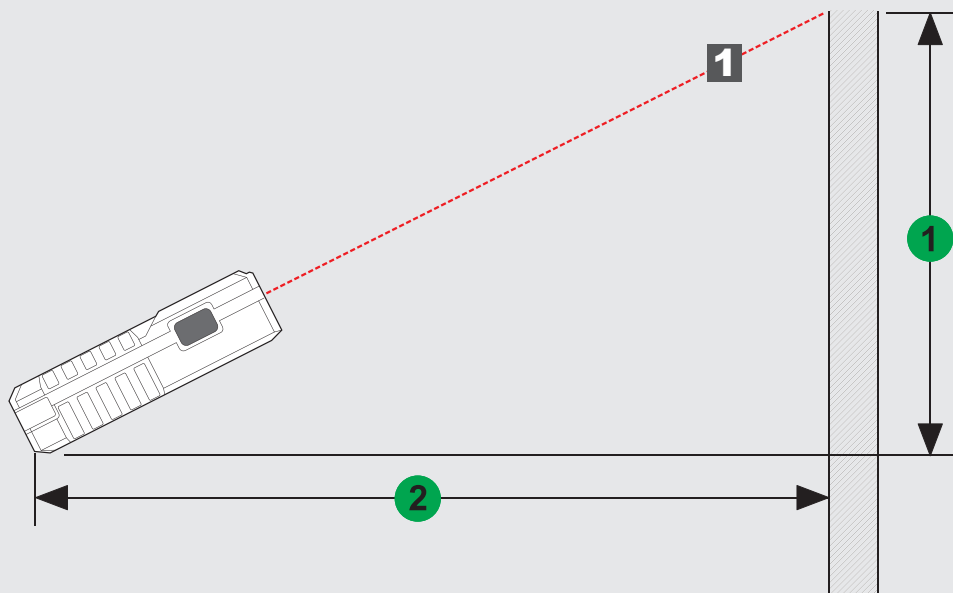
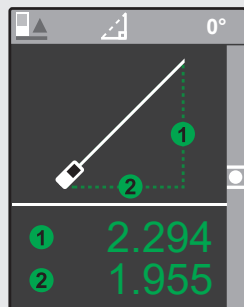
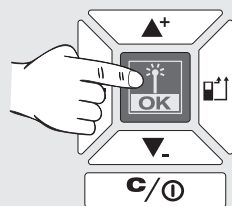

NEPŘÍMÉ MĚŘENÍ VÝŠKY (POUZE S LDM 100)

1

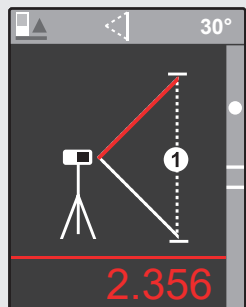

2

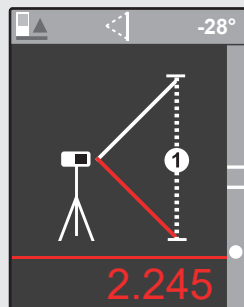
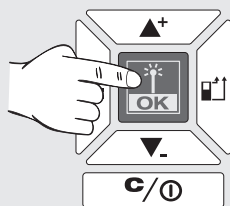

3

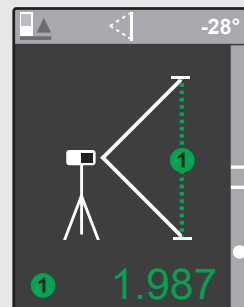
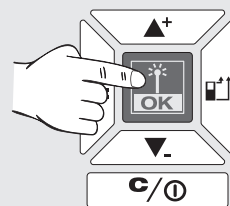

Použijte stativ nebo jinou stabilní plochu, abyste odměřili dvě rozdílné délky.

